

REACTIVE CONTROL COMPOSITION FOR MOBILE MANIPULATORS

by

BINU GEORGE MATHEW

Presented to the Faculty of the Graduate School of
The University of Texas at Arlington in Partial Fulfillment
of the Requirements
for the Degree of

MASTER OF SCIENCE IN COMPUTER SCIENCE

THE UNIVERSITY OF TEXAS AT ARLINGTON

December 2009

Copyright © by Binu George Mathew 2009

All Rights Reserved

To my wife, Bindu, the rock of my life.

ACKNOWLEDGEMENTS

I would like to thank my supervising professor Dr. Manfred Huber for his kind guidance and his patience during the course of my studies. I would also like to thank Dr. Farhad Kamangar and Mr. David Levine for being part of my thesis committee. I thank the Computer Science department at the University of Texas at Arlington for giving me the opportunity to study. I would like to thank my teachers who taught me during my years in school, in St. Xavier's, Ahmedabad, then in R.E.C., Durgapur and finally here at the UTA.

I would like to thank my labmates Giles D'Silva, Vamsikrishna Gopikrishna, Dr.Srividya Rajendran, Dr.Darin Brezeale, John Staton and others for their invaluable advice and help in completing my thesis.

I would like to thank my wife, Bindu, without whom this would not have been possible. Lastly, I would like to thank my parents, especially my mother who encouraged my interest in the sciences.

November 15, 2009

ABSTRACT

REACTIVE CONTROL COMPOSITION FOR MOBILE MANIPULATORS

Binu George Mathew, M.S.

The University of Texas at Arlington, 2009

Supervising Professor: Manfred Huber

A mobile manipulator is a manipulator mounted on a mobile platform. Due to this combination it has increased mobility compared to a fixed manipulator and increased dexterity compared to a mobile platform. At the same time it has a significantly higher number of degrees of freedom than fixed manipulators or mobile platforms and an increased task and workspace. In particular, the size of the workspace of the manipulator is restricted only by the workspace limitations of the mobile platform and the obstacles around the goal location. In addition, the extra degrees of freedom increase the number of ways in which a particular task can be performed. As a consequence of these properties, the task domain of a mobile manipulator is significantly larger than for other mobile platforms, allowing for a large variety of applications to be addressed. However, the operation of such a system becomes also more challenging because of the increased complexity of the task domain and the unstructured and uncertain environments that the robot generally operates in. Problems like kinematic singularities and non-holonomic constraints arise with increasing frequency and manipulation here critically depends on feedback during its interactions with the environment. As a consequence, a control technique applied to the mobile

manipulator must be able to deal with the unstructured, uncertain environment and multiple potentially interacting goals, and be able to address a broad range of operating contexts. It also must be flexible enough to allow the derivation of task-specific control instances without the need for complex reengineering of control structures while ensuring some level of completeness, correctness and robustness. Traditional control methods are challenged when applied to this domain, especially in terms of range of operating contexts. The control basis approach is used in this research to address this. In the control basis approach, behaviour is composed online from a set of base controllers which represent generic control objectives. By varying the composition functions of the base controllers, different tasks can be achieved. In this thesis, a control basis is designed and implemented on a mobile manipulator. Based upon the task, the control composition is derived from the control basis and applied to the robot. To demonstrate its operation, the results of multiple task-specific compositions are applied to and observed on a dynamic robot simulator.

TABLE OF CONTENTS

ACKNOWLEDGEMENTS	iv
ABSTRACT	v
LIST OF FIGURES	x
LIST OF TABLES	xi
Chapter	Page
1. INTRODUCTION	1
1.1 Mobile Manipulation	1
1.2 Contribution	4
2. RELATED WORK	6
2.1 Model Based Control	6
2.2 Hierarchical Control	7
2.3 Behaviour Based Control	7
2.4 Control Basis Approach	8
3. BACKGROUND	10
3.1 Motion Control	11
3.1.1 Configuration Space	12
3.1.2 Roadmap Based Path Planning	13
3.1.3 Cell Decomposition	15
3.1.4 Potential Fields	17
3.1.5 Harmonic Functions	18
3.2 Kinematic Conditioning Control	21
3.2.1 Manipulability Metric	21

3.3	Contact Control	23
3.4	Control Composition	23
4.	METHODOLOGY	25
4.1	Control Basis Approach	25
4.1.1	Generic Control Objectives	26
4.1.2	Mapping to Resources	26
4.1.3	Control Composition	28
4.2	Implementation for Mobile Manipulator	30
4.2.1	Harmonic Function Motion Control	30
4.2.2	Configuration Space	31
4.2.3	Harmonic Functions	31
4.2.4	Potential Field Relaxation	32
4.2.5	Gradient Computation	33
4.2.6	Manipulability Based Kinematic Conditioning Control	34
4.3	Control Composition	35
4.3.1	Constraints	36
5.	IMPLEMENTATION AND EXPERIMENTS	38
5.1	Implementation	38
5.1.1	Controllers	39
5.1.2	Composition Constraints	42
5.1.3	Sequential Composition	43
5.2	Experiments	43
5.2.1	Experiment 1	43
5.2.2	Hierarchy of Controllers	44
5.2.3	Constraints	45
5.2.4	Results	45

5.2.5	Experiment 2	48
5.2.6	Hierarchy of Controllers	48
5.2.7	Constraints	50
5.2.8	Results	51
6.	CONCLUSIONS AND FUTURE WORK	52
6.1	Conclusions	52
6.2	Future Work	53
Appendix		
A.	MANIPULATOR EQUATIONS	54
	REFERENCES	75
	BIOGRAPHICAL STATEMENT	78

LIST OF FIGURES

Figure	Page
3.1 Workspace	12
3.2 Configuration space	13
3.3 Visibility diagram	14
3.4 Voronoi diagram	14
3.5 Exact cell decomposition	15
3.6 Approximate cell decomposition	16
4.1 Control Composition	25
4.2 Controller	27
4.3 Controller Data Flow	27
5.1 Mobile Manipulator	39
5.2 Workspace Layout	43
5.3 Movement of Base and End effector in the workspace	46
5.4 Movement of End effector (X axis vs Z axis)	46
5.5 Movement of Base and End effector in the workspace with obstacle	47
5.6 Movement of End effector (X axis vs Z axis) with obstacle	47
5.7 Sequential Composition	48
5.8 Movement of Base and End effector with obstacles (Experiment 2)	51

LIST OF TABLES

Table		Page
5.1	Lookup table format	41

CHAPTER 1

INTRODUCTION

1.1 Mobile Manipulation

A mobile manipulator is a manipulator mounted upon a mobile platform. It has a higher number of degrees of freedom compared to fixed manipulators or mobile platforms and an increased task and work space. A manipulator mounted on a mobile platform greatly increases its workspace, restricted only by the workspace of the mobile platform and obstacles around the goal location. As it has increased mobility compared to fixed manipulators and increased dexterity compared to a mobile platforms, the task domain of the mobile manipulator is larger than other mobile platforms allowing a large variety of applications to be addressed. Moreover, the increase in the number of degrees of freedom increases the number of ways a particular task can be performed. On the other hand, the increased complexity of the task domain and the unstructured and uncertain environments that the robot generally operates in make the operation of such a system more challenging. Additional problems due to kinematic and dynamic coupling of the manipulator with the platform including kinematic singularities, non-holonomic constraints and inertial effects become more prevalent. In such a complex setting, manipulation critically depends upon feedback during its interactions with the environment. Furthermore, control techniques must be able to deal with multiple potentially interacting goals, unstructured and uncertain environments and a wide range of operating contexts. The control techniques must be flexible to be derived out of task-specific instances without the need for complex re-engineering of control structures while ensuring some level of completeness,

correctness and robustness.

The purpose of any robot is to perform given tasks. These tasks can vary from the extremely simple to very complex, only limited by the capabilities of the robot. The configuration of a robot is defined by the state of its sensors and actuators. A robot is said to have completed a task successfully when it gets into the correct configuration needed to achieve the task from a starting configuration. The robot moves step by step from the starting configuration to the correct configuration by using controllers. These controllers compute the next step to be taken depending upon the task. The controllers for a robot have evolved from very simple to very complex. This rise in complexity is associated generally with the complexity of the robot configuration and the nature of the task and the environment. Different methods of control have been used for different problems with varying degrees of success. With increasing complexity, the control methods have tried to solve the problem in different ways. One of them is building models of the environment, the task and the robot itself. Another method is reducing complexity of control by introducing hierarchies of control by abstracting the lower control levels. Still another method is controlling a robot largely reactively based upon its present state in the world. From the point of view of a controller, the sensors are its inputs while the actuators are its outputs. The sensors give information about the current configuration of the robot and the actuators move the robot to the desired configuration. The controller has the task of performing the sequence of configuration changes from the initial to the goal configuration. The controller also actuates the next change in configuration to be executed by the robot. The control complexity for robots depend upon the complexity of robot, the nature of the task to be performed by the robot and the environment. The complexity of the controller increases with an increase in sensors

and/or actuators or an increase in the complexity of the environment or of the geometric, physical or temporal constraints of the task.

Model-based control techniques are based on building kinematic and dynamic models of the robot[1],as well as models of the task and the environment. These models reflect the inherent properties of the robot. These techniques find it difficult to handle increasing complexity[2, 3]. With increasing complexity, the building up of the models also becomes more complex. Furthermore, the models could also have a temporal component i.e. the system could behave differently over time in addition there could be multiple, simultaneous and often conflicting objectives. The solutions to these,if they exist, could be multiple wherein the best solution has to be chosen out of all the available solutions.

Hierarchical control techniques have been used to counter the increasing complexity. In these control techniques control flows from top to bottom through a series of controllers to the lowest level controllers. The control is initialised at the top and depends on how the process has been abstracted prior to the initiation of action. This requires a complete and correct world representation along with a control hierarchy. Hierarchical control techniques become inflexible and rigid when the application domain is enlarged[2]. As changes occur in the world, it becomes more time consuming to decide on a complete and correct world representation and pre-plan for all eventualities that might occur. Moreover, using assumptions for the world representation would cause the control techniques not to reflect the actual nature of the world.

Behaviour-based control techniques[4] have been used to work around the inflexibility of hierarchical control techniques and model dependence. Behaviour is developed on-line using simple reactive behaviours which map stimulus to response. In order for the control technique to cover a broad range of operating contexts, a mechanism is provided for the behaviours to interact. As the complexity of the task domain increases,

the controller becomes a complex organisation of behaviour elements[2, 5, 6, 7]. All sensor and actuator alternatives have to be enumerated and all of the behaviours of the system must be precomputed for all foreseeable circumstances leading to complex organisations of behavioural elements.

The control basis approach works around the problem of increasing controller composition complexity by constructing behaviours online from reusable feedback controllers with formal stability and convergence results. The controllers have generic control objectives and are independent of the robot kinematics or the task geometry. The control is derived by associating the control laws with sensors and actuators. According to a task-dependent composition policy, these controllers are activated concurrently. The robot is decomposed into parts by assigning only subsets of the resources to the control laws. This reduces the number of possible control combinations of controllers with sensors and actuators[2]. It is possible by a careful selection of the controllers to robustly perform a wide range of tasks with only a small set of control laws. Different composition functions can achieve different tasks by using the same basis controllers. For complex tasks, the composition policy activates a sequence of concurrent activations of the controllers.

1.2 Contribution

The existing body of work on mobile manipulator control is generally specific to the hardware platform and/or to the task. The control basis approach however, can be applied to a wide variety of platforms, environments and tasks. In this thesis, the control basis approach has been implemented on a mobile manipulator. The control basis consists of robust solutions to the generic robot control tasks motion control and kinematic conditioning. Motion control is used to move the robot through the work space without collisions. Kinematic conditioning is used to optimise the artic-

ulated structure of the robot when it interacts with the world. For motion control, harmonic function path controllers have been implemented. These controllers are used to generate robust, reactive and collision free motion through the work space. They are resolution complete based on the cell decomposition of the environment and free of local minima[8]. The kinematic conditioning control optimises the manipulability metric. The manipulability metric is a scalar metric that describes the manipulator's ability to generate velocities and forces[9]. The kinematic conditioning controller ascends the manipulability metric improving the kinematic condition. A set of tasks are selected and the composition policy is derived based upon these tasks. The controllers are then activated concurrently based upon the policy. The results of multiple task-specific composition are observed on a dynamic robot simulator.

Chapter 2 describes related work to the thesis. It discusses different control approaches and the advantages that the control basis method offers. In Chapter 3 background related to the control basis method is described. The generic control objectives are described in this chapter. Also different methods to achieve these generic control objectives are described. Chapter 4 describes the methodology while Chapter 5 contains the implementation, the experiments and the observations. Chapter 6 contains the conclusion of the thesis based on the results achieved using the implementation described.

CHAPTER 2

RELATED WORK

There has been considerable research in the general area of mobile manipulation. This chapter is not intended to be an exhaustive discussion of the control approaches but rather a representative selection of different approaches. This chapter describes the different approaches to control and explains the approach taken by this thesis. The underlying assumption here is that a control approach which is scalable, flexible and not specific to the task or to the robot would be an ideal one. The control approach should be applied to different platforms without having the need for complex restructuring of existing control structures. It should have the ability to address a wide variety of tasks and should be able to deal with an increase in complexity of the robot or of the environment.

2.1 Model Based Control

Model based control involves building mathematical models of the robot and then generating control signals based upon these models. The robot is viewed as a system with many inputs and outputs. Any change in value of the inputs affects the value of the outputs. The control objective is to control the behaviour of the outputs. A kinematic model contains the relation between a set of degrees of freedom of the robot and their velocities. A dynamic model takes into account the forces applied on the robot. In general, the robot could be characterised by a set of differential equations and based on the derived models, control is applied on the robot. This technique is dependent on the kinematics of the robot platform [1, 3]. The complexity of model

based control increases as the complexity of the robot platform, task or environment increases, rendering it often intractable for complex control scenarios.

2.2 Hierarchical Control

The structure of a hierarchical control system is in the form of a tree. The top control level sets plans and goals which are sent to the lower control levels who decompose these plans and goals into sequences of sub plans and sub goals. The decomposition depends upon information from the sensors, the state of the control hierarchy and predictions from models, inference engines and knowledge bases[10]. A complete world representation and control hierarchy is required. The abstraction of the control process has to be done before initiation of actions. i.e. the complete path is planned out before any movement has occurred. Then the path is followed. This requires the assumption that the world is static. If there are changes then the path has to be recomputed. The time taken to plan and compute the path could increase resulting in inaction. To avoid this problem, assumptions about the changes that could occur can be made. However, this can lead to behaviour which could be dangerous for the robot. Also such behaviours would not reflect the actual nature of the interaction of the world with the robot. Therefore for a broad range of task domains, this requirement becomes difficult to fulfil resulting in rigid and inflexible behaviour. For mobile manipulators, hybrid approaches based on hierarchy and behaviour based control have been tried out to address these issues[11, 12].

2.3 Behaviour Based Control

Behaviour based control techniques are more flexible than hierarchical control. They involve building control from the bottom-up. The task is divided by exter-

nal manifestations of the robot control systems instead of the internal workings of the solution. The assumption is that the environment is not completely known and that changes occur during the movement of the robot. The controller reacts to the environment by an incremental change, then uses the sensors to update its information and then reacts again. In the subsumption based method[13], each controller is capable of providing a certain level of competence. The "superior" levels of competence include the "inferior" levels of competence as a subset. The "superior" level controller has the capability of examining data and inserting data into the "inferior" level controller. The behaviour is thus derived online from combinations of reactive behaviours. This approach does not have models to predict behaviour. The system designer must enumerate all sensors and actuator alternatives, derive a behaviour that maps stimulus to response. and provide some mechanism for the behaviours to interact. The "superior" controller can give and take control of the system from an "inferior" controller without requiring knowledge about the "inferior" controller. The same applies to the "inferior" controller. As the complexity of the task domain increase, the control structure become increasingly complex organisations of ad hoc control elements. For mobile manipulator research has been done trying a hybrid approach based on hierarchical and behaviour based control.[5, 6, 7].

2.4 Control Basis Approach

The control basis approach avoids the problem of increasing complexity in controllers. Behaviour is constructed online through the combination of reusable, predictable controllers whose control objectives are generic, independent of task geometry and robot kinematics. These controllers are associated with sensors and actuators to derive control. The controllers are activated concurrently based upon a task dependent composition policy. The stability and convergence results of the control basis

leads to stability and predictability in the composite controller[2]. Since the underlying control basis is independent of the robot kinematics or the task geometry the control basis can be applied to a wide variety of platforms and tasks. The control basis approach has been successfully applied for very different kinds of tasks on different platforms. e.g. for walking[14], or grasping[15]. In this thesis, the control basis approach has been applied to a mobile manipulator.

CHAPTER 3

BACKGROUND

In this thesis, the control basis uses generic robot control objectives to form controllers and control compositions for mobile manipulation tasks. The approach divides tasks into generic objectives: position, kinematic conditioning and force. To make them usable in a composition, the instantiated controllers have to provide the capability to trade off between different objectives. In addition, we would also like to obtain some predictability out of the composition. The controllers used as well as the composition scheme should provide and maintain stability, robustness and predictability. The control objectives are kinematically independent of the robot platform. Different tasks can be achieved by using the same basis controllers in different composition functions. Since the controllers have stability and convergence guarantees, a carefully designed composition policy will lead the robot through a sequence of equilibria towards the goal. However, not all composition policies can lead the robot towards a specific goal but rather the design of the composition policy is such that it determines the sequence of equilibria that the robot will follow to reach the goal. As a consequence, tasks are not defined in geometric terms but rather as sequences of kinematic conditioning or navigational objectives. Progress towards achieving the tasks is through activation of the corresponding controllers. This chapter provides background on the three control objectives as well as on traditional nullspace control techniques used to trade off the effects in multi-objective control.

3.1 Motion Control

This control element has the objective of robot position. Depending upon the position of the robot in the workspace, the control element computes a step for the robot. The output from this element should not cause any collisions and should be able to deal with any perturbations that occur along the path. The goal of motion control (or path planning) is, given an initial position and orientation and a goal position and orientation of a robot in an euclidean space, called workspace(Figure 3.1), to move the robot along a path, specifying a continuous sequence of positions and orientations of the robot that avoids contact with the obstacles and, starting at the initial position and orientation, ends in the goal pose[16].

The state of the robot can be represented by the degrees of freedom of the robot. All possible values of the degrees of freedom together represent the state space of the robot. The path planner suggests an action to be taken, given the current state of the robot which is then sent to the robot.

Actions are used to change the state of the robot. The path planner is responsible for the actions suggested to move from the initial state to the goal state. The change in state can be expressed as a state transition function in case of discrete time steps or as an ordinary differential equation in case of continuous time.

Path planners and planning algorithms are used in many different areas like robotics, manufacturing, warfare, video games etc.. In manufacturing, one of the most common applications is to plan the path of manipulators on the assembly line [17]. Unmanned air vehicles, commonly used by the US defence forces, use path planning algorithms to fly[18]. Unmanned submarines have been developed which use path planning to navigate under the ocean surface. GPS based navigation systems use path planning algorithms to find the best route to the destination. In video games, the movement

of objects are determined using path planning algorithms. The planetary rovers, sent to other planets have used path planning algorithms to navigate.

3.1.1 Configuration Space

Configuration space, also called C-space is a representation tool for path planning of a robot. The robot, whether simple or complex, is transformed into a single point in C-space. The obstacles are also mapped into the C-space and are called C-obstacles. The dimensions of the C-space are equal to the degrees of freedom of the robot. An example of a robot in the workspace and its corresponding C-space are shown in Figure 3.1 and Figure 3.2, respectively. Let the configuration space be C , the space where the robot can move freely without colliding with obstacles be C_{free} , the space occupied by the C-obstacles in configuration space be $C_{obstacles}$ then,

$$C = C_{free} \cup C_{obstacles}$$

The transformation from configuration space into workspace coordinates is called

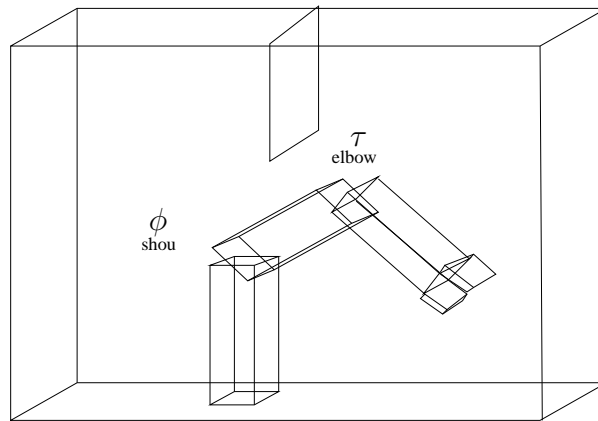

Figure 3.1. Workspace.

forward kinematics. It can be solved by using coordinate transformations or by us-

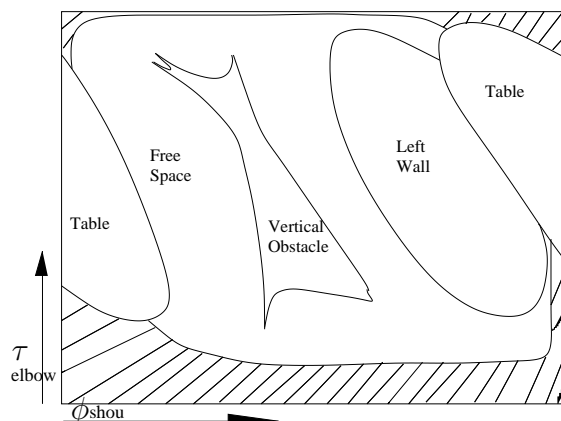

Figure 3.2. Configuration space.

ing geometry. The number of transformations is equal to the degrees of freedom of the robot. The inverse problem i.e. transformation of workspace coordinates into configurations space is called inverse kinematics. Calculating inverse kinematics is generally hard, especially with robots with many degrees of freedom. Solutions are rarely unique.[16, 19]

3.1.2 Roadmap Based Path Planning

In roadmap based path planning, a set of curves are drawn based on particular criteria. By using this set of curves as possible roads, a continuous path between two points in the C-space may be found if it exists [16]. The connectivity of the free space is captured in a network of one dimensional curves. Once the network has been constructed the initial and the goal configurations are connected to the network and a path between these two points is searched for.

The visibility graph method, a frequently used roadmap technique is mainly used for two dimensional configuration spaces with polygonal C-obstacles. The visibility graph is a non-directed graph containing all line segments between vertices of the C-obstacles and the initial and goal configuration points (Figure 3.3). The resultant

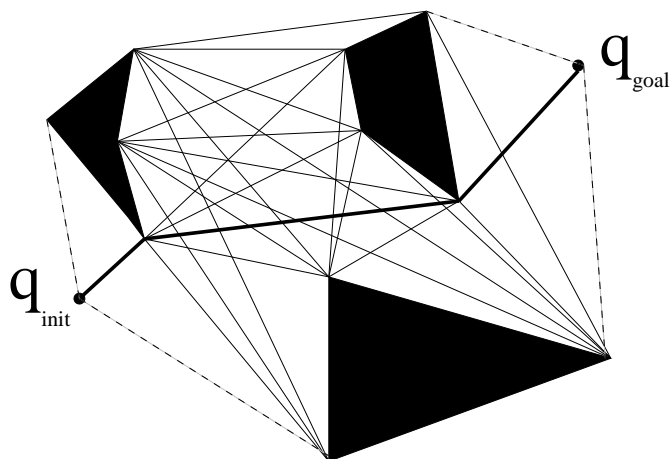

Figure 3.3. Visibility diagram.

path, if it exists, is a piecewise linear curve between the initial and goal configuration points passing through C-obstacle vertices.

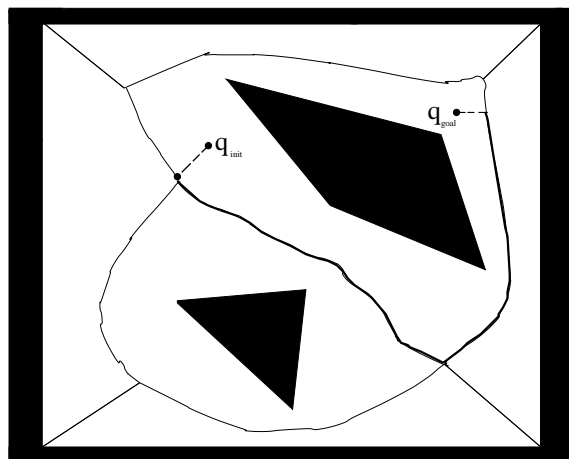

Figure 3.4. Voronoi diagram.

Another roadmap method, the retraction method, consists of defining a continuous function of C_{free} onto a one dimensional subset of itself. In a two dimensional configuration space, C_{free} is retracted onto its Voronoi diagram [16]. The Voronoi diagram is the set of all configurations whose minimal distance to the C-obstacles is achieved

by at least two points on the boundary of the C-obstacle region (Figure 3.4). The initial and goal configurations are also retracted into the subset. The advantage of this approach is that it tends to maximise the clearance between the robot and the obstacles.[16][19]

Roadmap based path planners are usually applied to lower dimensional C-spaces. From a point in C-space, there are few choices, if any of paths to be taken to move towards the goal. Different paths cannot be compared. In control composition however, outputs from controllers have to be traded off against each other. This requires that there are many different paths available. and that the paths could be compared with each other. The absence of these capabilities makes it difficult to use a roadmap based motion controller in the control basis.

3.1.3 Cell Decomposition

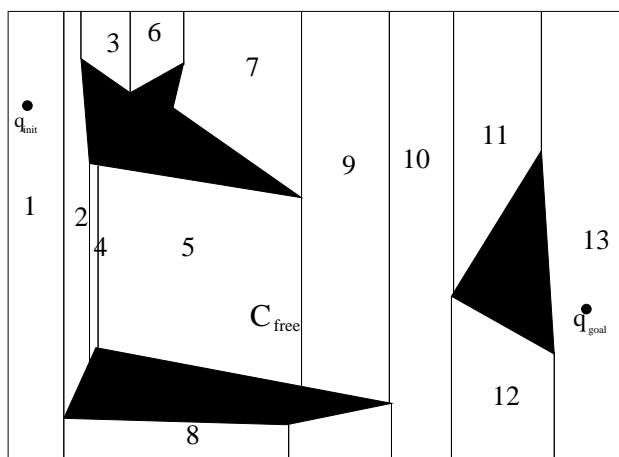

Figure 3.5. Exact cell decomposition.

In cell decomposition approaches, the free space is decomposed into a finite number of contiguous regions, called cells [16]. The path planning problem between

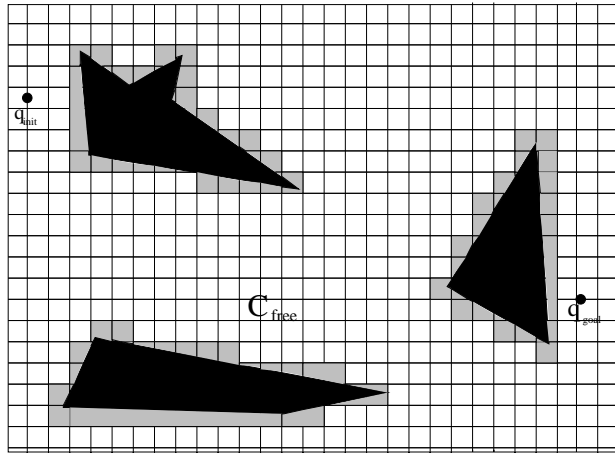

Figure 3.6. Approximate cell decomposition.

any two cells can be solved by simple means like moving through adjacent free cells from the first cell until the goal cell is reached. The path planning problem becomes a discrete graph search problem where the nodes in the graph are cells. The nodes are connected to each other if and only if they are adjacent. The adjacency list can be constructed and searched. A continuous free path can be computed from the results of the search of the adjacency list. Exact cell decomposition methods decompose the free space into cells whose union is exactly the free space (Figure 3.5). Approximate cell decomposition methods decompose the free space into cells of predefined shape (Figure 3.6). The union of these cells is in the free space. The boundary of a cell does not hold any physical meaning [16][19]. Exact cell decomposition methods are complete. However, they are much more difficult to implement than approximate methods. Approximate cell decomposition methods can be shown to be resolution-complete. Also, the precision of the approximation can be changed, leading to varying degrees of completeness, dependent on resolution. A continuous free path can be computed by following adjacent cells.

Cell decomposition methods offer more choices in the path to be taken to move

towards a goal configuration. However, in case of exact cell decomposition methods, the problem is similar to that of the roadmap based path planning methods, i.e. the lack of choices in the path to be taken and a lack of mechanism to compare different paths. In case of inexact cell decomposition, different paths could be taken from the initial configuration to the goal configuration using different free cells. However, there is lack of a mechanism to compare between free cells due to the simple adjacency graph search used to compute paths.

3.1.4 Potential Fields

Potential field methods involve applying an artificial potential that depends on the goal configuration and C-obstacles [16]. The potential at a particular point is derived from an artificial potential function. The potential function tries to reflect the structure of the space. In simple approaches, the potential function is defined as the sum of two different potential functions, one attractive and one repulsive. Goals produce attractive forces and obstacles produce repulsive forces. At every configuration the resultant force computed from the artificial potential acting upon the robot is considered to be the best direction to be taken by the robot. This direction is then used by the robot to move, causing some incremental change in configuration[16, 19]. The field of artificial forces $\vec{F}(q)$ in C is produced by a differential function $U : C_{free} \rightarrow R$, with :

$$\vec{F}(q) = -\vec{\nabla}U(q)$$

where $\vec{\nabla}U(q)$ denotes the gradient vector of the potential function U at configuration q .

In its simplest form, U is constructed as the sum of two elementary potential functions:

$$U(q) = U_{att}(q) + U_{rep}(q)$$

where U_{att} is the attractive potential associated with the goal configuration q_{goal} and U_{rep} is the repulsive potential associated with the C-obstacle region.

\vec{F} is the sum of two vectors:

$$\vec{F}_{att} = -\vec{\nabla}U_{att} \text{ and } \vec{F}_{rep} = -\vec{\nabla}U_{rep}$$

which are called the attractive and repulsive forces respectively.

In order to achieve completeness, the potential function used should not have any local extrema. An ideal function for the potential field method would be a function without local extrema, with a minimum at the goal, and which is continuous over the whole space. Such functions are called navigation functions and one such family of functions, harmonic functions are used as a potential function here. Harmonic functions do not have local extrema and are continuous over the whole space. Since harmonic functions do not have local extrema, a path planner using them is complete as the goal would be a global extremum[8]. Since they are continuous, the gradient exists at all points in C-space. This makes it possible to compare paths or evaluate the quality of a path based upon a criteria. In control composition, this property becomes very useful as different controllers are composed with each other. This property helps in identifying paths which satisfy the composition policy. Furthermore potential field controllers are robust in that they do not rely on perfect path following but rather adjust reactively to perturbations.

3.1.5 Harmonic Functions

A Harmonic function is a real function with continuous second partial derivatives which satisfies Laplace's equation. On a domain $\Omega \subset \mathbf{R}^n$, Laplace's equation can be defined as

$$\nabla^2 U = \sum_{i=1}^n \frac{\partial^2 U}{\partial x_i^2}$$

The function U is said to be harmonic if it satisfies Laplace's equation. A harmonic function does not have local minima or maxima[8] and when used in path planning, the negative gradient is used to reach the goal configuration. All obstacles are kept at the highest potential while the goals are at the lowest potential. The path generated follows the negative gradient to the goal configuration.

3.1.5.1 Numerical Solutions of Laplace's Equation

There are various methods to solve Laplace's equation and thus to compute harmonic functions. Laplace's equation is linear and homogeneous and can be represented by a linear system of equations $Ax = b$, where the i^{th} equation is

$$\sum_{j=1}^n a_{ij}x_j = b_i \quad (3.1)$$

with

$$A = \begin{bmatrix} a_{11} & a_{12} & \cdots & a_{1n} \\ a_{21} & a_{22} & \cdots & a_{2n} \\ \cdots & \cdots & \cdots & \cdots \\ a_{n1} & a_{n2} & \cdots & a_{nn} \end{bmatrix}, x = \begin{bmatrix} x_1 \\ x_2 \\ \cdots \\ x_n \end{bmatrix}, b = \begin{bmatrix} b_1 \\ b_2 \\ \cdots \\ b_n \end{bmatrix}$$

The harmonic function used as a potential function in this thesis is

$$U_i = \frac{1}{\aleph_{neighbours}} \sum U_j$$

where U_i represents the potential at the i^{th} node, $\aleph_{neighbours}$ the number of neighbours and U_j the neighbouring nodes. In the general form of equation (3.1), the i^{th} equation is

$$\sum_{j=1}^n a_{ij}U_j = b_i$$

where, if the i^{th} node is a goal or an obstacle

$$a_{ij} = \begin{cases} 0 & \text{if } i \neq j \text{ and the } i^{\text{th}} \text{ node is a goal or obstacle} \\ 1 & \text{if } i = j \text{ and the } i^{\text{th}} \text{ node is a goal or obstacle} \end{cases}$$

If the i^{th} node is not a goal or obstacle then

$$a_{ij} = \begin{cases} -1 & \text{if } i = j \\ 0 & \text{if the } i^{th} \text{ node and the } j^{th} \text{ node are not connected} \\ \frac{1}{\aleph_{neighbours}} & \text{if } i^{th} \text{ node and } j^{th} \text{ node are neighbours} \end{cases}$$

$$b_i = \begin{cases} 0 & \text{if } i^{th} \text{ node is a goal} \\ 1 & \text{if } i^{th} \text{ node is an obstacle} \\ 0 & \text{if } i^{th} \text{ node is neither a goal or obstacle} \end{cases}$$

The Gauss elimination method uses elementary row operations to reduce the matrices to a triangular form to find a solution. This, however, is computationally expensive. Another approach is to start with an initial approximation to the solution and iteratively change it to bring it closer to the true solution. The Gauss-Seidel method and the Jacobi method are used for general matrices. The Jacobi method solves for U_i assuming the other entries of x remain fixed. This gives

$$U_i^{(k)} = \frac{b_i - \sum_{j \neq i} a_{ij} U_j^{(k-1)}}{a_{ii}}$$

for the k^{th} iteration. In the Gauss-Seidel method, for the k^{th} iteration,

$$U_i^{(k)} = \frac{b_i - \sum_{j < i} a_{ij} U_j^{(k)} - \sum_{j > i} a_{ij} U_j^{(k-1)}}{a_{ii}}$$

The Gauss-Seidel method uses the updated values. This makes convergence to the solution faster than in the Jacobi method[20]. The Successive Over Relaxation(SOR) method is derived by extrapolating the Gauss-Seidel method. A weighted average is taken between the previous iterate and the computed Gauss-Seidel iterate successively for each component.

$$U_i^{(k)} = \omega \bar{U}_i^{(k)} + (1 - \omega) U_i^{(k-1)}$$

This accelerates the rate of convergence of the iterates to the solution. If $\omega = 1$, then the SOR method becomes the Gauss-Seidel method. It has been shown that SOR

fails to converge if $\omega \notin (0, 2)$.

The solutions to Laplace's equation can be computed using two forms of boundary conditions. In Dirichlet style boundary conditions, the potential at the boundary is fixed to a constant maximum value. All C-obstacles are also set to the constant maximum value. This makes the potential flow outward normal to the obstacle surface. In Neumann style boundary conditions, the gradient vectors are constrained to be tangential to the obstacle boundary. Since solutions to Laplace's equation obey the principle of superposition, the two solutions computed with the different boundary conditions can be combined into a harmonic function. This harmonic function will exhibit behaviour somewhere between the two original solutions[8].

$$U = kU_{Dirichlet} + (1 - k)U_{Neumann}, \text{ where } k \in [0, 1]$$

3.2 Kinematic Conditioning Control

This control element improves the configuration of the articulate structure of the robot when it is interacting with the world. This allows the robot to maintain a favourable posture that allows adjustments to changes caused by other controllers.

3.2.1 Manipulability Metric

The manipulability metric proposed by Yoshikawa[9] is a measure of the robot's ability to generate velocities or forces. A high value of the manipulability metric would indicate that the present posture is capable of moving easily in any direction. The manipulability metric is derived from the Jacobian matrix of the robot.

If the following relation holds between a k-dimensional vector $\xi = [\xi_1, \xi_2, \xi_3, \dots, \xi_k]^T$

and an l-dimensional vector $\eta = [\eta_1, \eta_2, \eta_3, \dots, \eta_l]^T$:

$$\eta_j = f_j(\xi_1, \xi_2, \dots, \xi_k), j = 1, 2, 3, \dots, l$$

then the $l \times k$ matrix

$$J_\eta(\xi) = \begin{bmatrix} \frac{\partial \eta_1}{\partial \xi_1} & \frac{\partial \eta_1}{\partial \xi_2} & \cdots & \frac{\partial \eta_1}{\partial \xi_k} \\ \frac{\partial \eta_2}{\partial \xi_1} & \frac{\partial \eta_2}{\partial \xi_2} & \cdots & \frac{\partial \eta_2}{\partial \xi_k} \\ \cdots & \cdots & & \cdots \\ \frac{\partial \eta_l}{\partial \xi_1} & \frac{\partial \eta_l}{\partial \xi_2} & \cdots & \frac{\partial \eta_l}{\partial \xi_k} \end{bmatrix}$$

is called the Jacobian matrix of η with respect to ξ . The Jacobian matrix is used in robotics to express the relation between the end effector velocity and the joint velocities of a manipulator in a compact form.[9] The manipulability metric is used as a measure of the ability of a manipulator to generate velocities or forces. The configurations with the highest value of the manipulability metric are optimal with respect to velocity. At such configurations, the manipulator can generate velocities in any direction. The manipulability metric w is defined as,

$$w = \sqrt{\det(\mathbf{J}(\mathbf{q})\mathbf{J}^T(\mathbf{q}))},$$

where \mathbf{J} is the Jacobian matrix and \mathbf{q} is the manipulator configuration. For a non-redundant manipulator the metric w reduces to

$$w = |\det \mathbf{J}(\mathbf{q})|$$

[9]. The manipulability metric can be computed at every point in configuration space. This gives us a function which reflects the quality of a configuration of the articulated structure of the robot. The kinematic conditioning controller uses this function to move the robot to desired configurations by computing control steps that ascend the potential field described by the manipulability metric over the configuration space of the articulated structure.

3.3 Contact Control

Contact control involves actions to push, pull, lift or drop objects in the world by the robot. This is another generic control objective. It has not been implemented in this thesis.

3.4 Control Composition

The controllers when used by themselves achieve their objectives which are motion control, kinematic conditioning and contact control. Depending upon the nature of the task to be done, a composition of the controls is required. Control composition has been done using null space control. In null space control[21], the null space of the higher level controllers is used by the lower level controllers. This ensures that the effect of change caused by the lower level controller does not affect the higher level controller. Output from other controllers are projected onto the null space of the controller. Only the orthogonal component of the lower level controller to the higher level controller is allowed. These outputs do not affect the output of the higher level controller. Thus, in null space control the output of the higher level controller is never affected by the output of the lower level controller. In the control basis approach, this constraint is somewhat relaxed such that the "subordinate" controllers are restricted to areas which do not counteract the control objectives of the "dominant" controllers. They need not be orthogonal with respect to each other. Any output that improves or maintains the output of the higher level controller is legally valid. This increases the range of controllers which could be used in the control basis method.

Each instance of these controllers takes the form of $\phi_i \frac{\sigma}{\tau}$, where ϕ_i is an element of the control basis and σ and τ denote the set of input and output resources. σ and τ could be the sensors or sensor abstractions and actuators respectively. These con-

trollers are activated concurrently based on a task dependent composition policy. Concurrent activation would be either asynchronous (";") or using the "subject to" ("<") constraint. The elements of the control basis need not be orthogonal with respect to their control objectives but they could be made orthogonal using the "subject to" ("<") composition[14].

CHAPTER 4
METHODOLOGY

4.1 Control Basis Approach

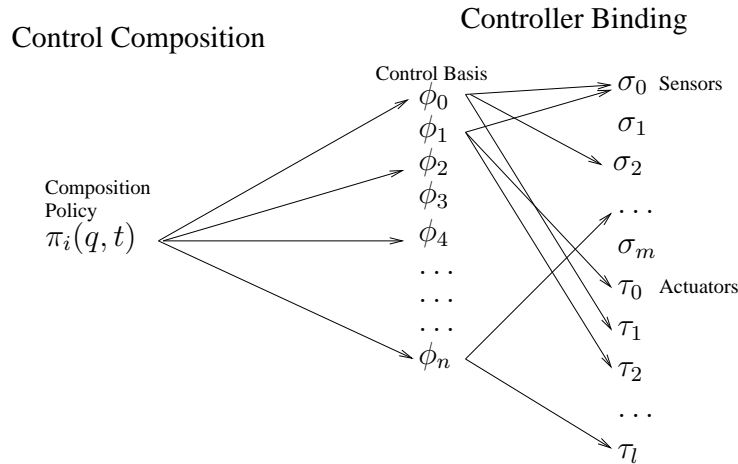

Figure 4.1. Control Composition.

The control basis approach derives behaviour online from a set of generic control objectives which are associated with sensors and actuators of the robot (Figure 4.1). The controllers are activated concurrently based on a task dependent composition policy. A careful design of the control basis can serve a wide range of tasks. By using generic control objectives which are largely independent of task geometry or robot kinematics, the control basis approach allows the tasks to be defined in terms of generic control objectives. Different tasks could be achieved by using different composition functions over the same set of controllers. In this thesis, the control basis approach has been applied to mobile manipulators. Using a set of generic control objectives, it is possible to achieve different tasks on the mobile manipulator.

By changing the association between control objectives and sensors and the actuators, it is possible to build different controllers. Furthermore, by using different controller compositions it is possible to derive different behaviours for different tasks.

4.1.1 Generic Control Objectives

A robot mostly is either moving somewhere, pushing, pulling or lifting something or modifying itself. Most of the activities of a robot are concerned with its location, velocity, orientation in the world, the articulated structure of the robot itself and the force it applies when interacting with the world. In terms of control objectives, activities concerning location, velocity and orientation are motion control whereas activities concerned with the structure of the robot are kinematic conditioning control and activities concerning force applied on the world would be force control. These control objectives cover most of the activities of the robot in its interaction with the world. For the mobile manipulator, these control objectives are used to achieve different tasks. The motion control objective helps achieve location, velocity and orientation of the base and the manipulator in the world, the kinematic conditioning control objective would optimise the articulated structure of the mobile manipulator and the force control objective would help achieve the moving of objects by pulling, pushing, lifting or dropping.

4.1.2 Mapping to Resources

The control objectives are mapped to a set of sensors and actuators of the robot. This forms a controller (Figure 4.2). From the subspace of the robot covered by the sensors, sensor data is transformed into the state space of the control objective. The control objective is applied to this sub-structure and a gradient is computed in this control space. This is then transformed into commands in the bound actuator space

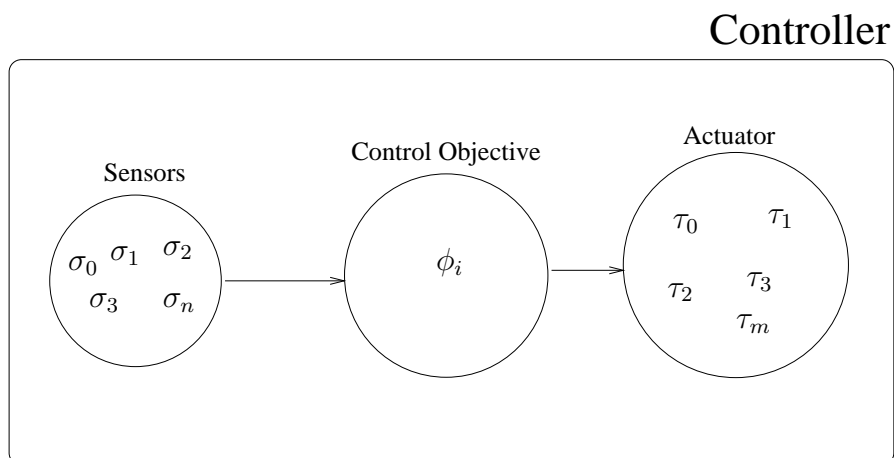

Figure 4.2. Controller.



Figure 4.3. Controller Data Flow.

through Jacobians, constrained or unconstrained (Figure 4.3). The Jacobian matrix expresses the relationship between the different output spaces. The controller output is transformed from output in the control space into output in the bound actuator space by using a Jacobian. Depending upon the output required the Jacobian is constrained or unconstrained. For example, in a mobile manipulator the location of the base has no dependence on the joint angles of the manipulator and vice versa. A relation could be created by keeping the location of a point on the manipulator at a particular place in the world. This causes a relation between location of the base and the joint angles of the manipulator. In this case there is no relation between the sensors and the actuators. The fixed endpoint constraint imposed on the Jacobian forces a relationship between the two independent spaces.

4.1.3 Control Composition

The composition of controllers for a robot is task dependent. The composition function is designed based upon the nature of the task. The controllers are activated concurrently based upon the composition function.

4.1.3.1 Hierarchical Parallel Composition

The individual controllers are activated concurrently. The controllers could either be asynchronous or be subject to another controller. For example,

$$\left(\begin{matrix} \text{Base, Manipulator} \\ M \end{matrix} \phi_{\Theta_i, X_j}^{\theta_i, x_j} \right) \triangleleft \left(\begin{matrix} \text{Base} \\ H \end{matrix} \phi_{X_j}^{x_j} \right) \triangleleft \left(\left(\begin{matrix} \text{Manipulator} \\ H \end{matrix} \phi_{\Theta_i}^{\theta_i} \right); \left(\begin{matrix} \text{Manipulator} \\ M \end{matrix} \phi_{\Theta_i}^{\theta_i} \right) \right)$$

where ϕ is the controller M represents a manipulability based controller, H represents a harmonic function based controller, θ represents the joint angles, Θ represents the joint actuators, x represents the base location and X represents the base actuators on the mobile manipulator.

In this control composition the four controllers are activated concurrently. The $\left(\begin{matrix} \text{Manipulator} \\ H \end{matrix} \phi_{\Theta_i}^{\theta_i} \right)$ and $\left(\begin{matrix} \text{Manipulator} \\ M \end{matrix} \phi_{\Theta_i}^{\theta_i} \right)$ controllers are asynchronous. The $\left(\begin{matrix} \text{Base} \\ H \end{matrix} \phi_{X_j}^{x_j} \right)$ is subject to the $\left(\begin{matrix} \text{Manipulator} \\ H \end{matrix} \phi_{\Theta_i}^{\theta_i} \right)$ and $\left(\begin{matrix} \text{Manipulator} \\ M \end{matrix} \phi_{\Theta_i}^{\theta_i} \right)$ controllers whereas the $\left(\begin{matrix} \text{Base, Manipulator} \\ M \end{matrix} \phi_{\Theta_i, X_j}^{\theta_i, x_j} \right)$ is subject to the rest of the controllers. In this task, a manipulator manipulability controller and a harmonic controller run asynchronously. Both of them are dominant. This ensures that the manipulator reaches the goal while maintaining an optimised kinematic conditioning. A base harmonic controller is subject to both of the above controller. This controller moves the base towards a goal subject to the above controllers. A manipulability controller for the whole mobile manipulator is the most submissive controller. This ensures that the mobile manipulator as a whole maintains optimised kinematic conditioning subject to the base

harmonic motion controller as well as the manipulator harmonic motion controller and the manipulator manipulability controller.

4.1.3.2 Sequential Composition

A complex task is divided into a sequence of sub-tasks. Each of these sub-tasks has a composition function based on the same control basis. Upon completion of a sub-task, the composition policy changes the composition function as per the next sub-task in the sequence. The overall composition policy is a sequence of composition functions, each of which has concurrent control activations. This leads the robot through a series of sub-goals to the final goal. For example,

$$\left(\left({}_{H}^{Base} \phi_{\bar{X}_j}^{x_j} \right) \triangleleft \left({}_{H}^{Manipulator} \phi_{\Theta_i}^{\theta_i} \right) \right) \rightleftharpoons \left({}_{H}^{Manipulator} \phi_{\Theta_i}^{\theta_i} \right) \rightarrow \left({}_{H}^{Gripper} \phi_{\Theta_g}^{\theta_g} \right)$$

where ϕ is the controller M represents a manipulability based controller, H represents a harmonic function based controller, θ represents the joint angles, Θ represents the joint actuators, x represents the base location, X represents the base actuators and *Gripper* represents the gripper on the mobile manipulator.

In this control composition, the composition $\left(\left({}_{H}^{Base} \phi_{\bar{X}_j}^{x_j} \right) \triangleleft \left({}_{H}^{Manipulator} \phi_{\Theta_i}^{\theta_i} \right) \right)$ is activated. Following the convergence of this composition, the $\left({}_{H}^{Manipulator} \phi_{\Theta_i}^{\theta_i} \right)$ is activated. Following this, $\left({}_{H}^{Gripper} \phi_{\Theta_g}^{\theta_g} \right)$ is activated. In this task, first the harmonic motion controller keeps the manipulator on a goal while the base harmonic controller moves towards its goal subject to the manipulator harmonic controller. When this sub-task has converged, the second sub-task is executed. Here, the harmonic motion controller for the manipulator moves the manipulator towards a goal. If it fails, the first sub-task is re-executed. If it succeeds then the third sub-task i.e. the gripper controller moves the gripper.

4.2 Implementation for Mobile Manipulator

A mobile manipulator is a manipulator which has been mounted on a mobile platform. The mobile manipulator has an increased task and work space compared to a fixed manipulator or mobile platform. The mobility given by the mobile platform to the manipulator increases the workspace, allowing particular tasks to be achieved in multiple ways. The task domain is more complex compared to a fixed manipulator or a mobile platform and there are often multiple goals which may potentially interact and a wide range of operating contexts. Problems like kinematic singularities and non-holonomic constraints also become more prevalent. The solutions offered by the control basis need to be complete, correct and robust. They also should be able to deal with perturbations. Since control is composed from different controllers there has to be a mechanism to compare different outputs from the controller. Since composition takes place, the most optimal output is not always chosen. The controllers should have the ability to compute a solution from any given point in its control space. They should be continuous and complete over the control space.

4.2.1 Harmonic Function Motion Control

Harmonic function path planners are used as controllers to generate paths for the robot. The paths generated are a direct result of the robot's state in the configuration space. Harmonic functions are solutions to Laplace's equations and are used here to calculate a potential over the configuration space. Goals and obstacles are assigned a fixed potential and there exists a potential at each point of the configuration space. The potential obtained does not have any local extrema leading to resolution complete and correct motion control. While there are possibly saddle points, a search of the neighbouring space could find a way out of the saddle point. Usually, the goals are at the lowest potential and obstacles are at the highest and the rate of change

in potential at a point on the potential field provides the direction and magnitude of the change in configuration of the robot. The path followed is a gradient descent on the control surface to the goal.

4.2.2 Configuration Space

The configuration space used is a discretized representation of the environment expressed in terms of the degrees of freedom of the input sub-structure or structure bound to the control objective. Usually, it is a bounded environment. Objects, goals and the robot are transformed into this space. The dimensionality of this space is the number of degrees of freedom of the robot, transforming the robot into a single point in this space. This avoids the geometric and kinematic effects of change in configuration in the real world. The process of path planning is reduced in complexity by using this configuration space. However, transformation functions have to be used to also transform goals and obstacles into this robot-centric configuration space.

4.2.3 Harmonic Functions

Harmonic functions are a solution to Laplace's equation. They are used to generate smooth, collision free paths which do not contain local extrema. The harmonic function calculates the potential at a node by taking the average of the potential value of its neighbours. Let $U(1q_i, 2q_j, 3q_k, \dots, nq_z)$ be the harmonic function that

represents the potential value of a node located at $(1q_i, 2q_j, 3q_k, \dots, nq_z)$, where nq_z is the z^{th} node in the n^{th} dimension then the equation of the harmonic function is

$$\begin{aligned}
 U(1q_i, 2q_j, 3q_k, \dots, nq_z) = & (\\
 & U(1q_{i-1}, 2q_j, 3q_k, \dots, nq_z) + U(1q_{i+1}, 2q_j, 3q_k, \dots, nq_z) + \\
 & U(1q_i, 2q_{j-1}, 3q_k, \dots, nq_z) + U(1q_i, 2q_{j+1}, 3q_k, \dots, nq_z) + \\
 & \dots \dots \dots \\
 & U(1q_i, 2q_j, 3q_k, \dots, nq_{z-1}) + U(1q_i, 2q_j, 3q_k, \dots, nq_{z+1}) \\
 &) / (n * 2)
 \end{aligned}$$

4.2.4 Potential Field Relaxation

The successive over relaxation(SOR) method is used to solve the homogeneous system of linear equations describing the harmonic potential values. This technique is based on the Gauss-Seidel iteration. The iterations terminate when the magnitude of the update on an iteration falls below a specified value. This value can be made arbitrarily small depending upon the floating point precision of the processor. SOR converges faster than Gauss-Seidel by using a well chosen relaxation factor ω , where $0 \leq \omega \leq 2$. This factor is used to accelerate the convergence of the potential value as shown below. For the k^{th} iteration,

$$\begin{aligned}
 U^{(k+1)}(1q_i, 2q_j, 3q_k, \dots, nq_z) = & U^{(k)}(1q_i, 2q_j, 3q_k, \dots, nq_z) + \\
 & \omega((U^{(k+1)}(1q_{i-1}, 2q_j, 3q_k, \dots, nq_z) + U^{(k)}(1q_{i+1}, 2q_j, 3q_k, \dots, nq_z) + \\
 & U^{(k+1)}(1q_i, 2q_{j-1}, 3q_k, \dots, nq_z) + U^{(k)}(1q_i, 2q_{j+1}, 3q_k, \dots, nq_z) + \\
 & \dots \dots \dots \\
 & U^{(k+1)}(1q_i, 2q_j, 3q_k, \dots, nq_{z-1}) + U^{(k)}(1q_i, 2q_j, 3q_k, \dots, nq_{z+1})) / (2 * n) - \\
 & U^{(k)}(1q_i, 2q_j, 3q_k, \dots, nq_z)
 \end{aligned}$$

Anticipating future changes in potential value at the node caused by the current changes, the relaxation factor is used to raise the potential. This anticipates that increases in value will cause the potential value of the neighbours to increase which in turns raises its own potential value. As a result, a well chosen relaxation factor significantly reduces the number of iterations required to converge. If this factor is chosen too large on the other hand, there is a possibility where the potential grid does not relax but where potential values oscillate. The best choice of the relaxation factor depends on the dimensionality of the configuration space and for a factor of $\omega = 1$, the SOR method reduces to the Gauss-Seidel iteration method.

4.2.5 Gradient Computation

The harmonic function path planner follows the gradient of the potential field. The gradient provides the direction for motion at every point in the potential field which is a point in configuration space. Since the potential field is discretized, the potential value of a point is computed by linearly interpolating from the potentials of its surrounding nodes. There are no local extremas and the goals have a minimum potential value and the obstacles a maximum potential value. The negative gradient of the potential field is computed which will direct the robot to a goal. It is important to note here, however, that any direction that leads to a reduction in potential represents a legal beginning of a correct path that leads to the goal. This allows the harmonic function controller to react to composition constraints by trading off path optimality without losing correctness. The gradient is computed by finding the dif-

ference between neighbours in each dimension divided by the distance between them.

$\vec{\pi}_{1q_i, 2q_j, 3q_k, \dots, nq_z}$, the gradient at point $(1q_i, 2q_j, 3q_k, \dots, nq_z)$, is calculated as

$$\vec{\pi}_{1q_i, 2q_j, 3q_k, \dots, nq_z} = \left(\begin{array}{c} \frac{U(1q_{i-1}, 2q_j, 3q_k, \dots, nq_z) - U(1q_{i+1}, 2q_j, 3q_k, \dots, nq_z)}{2\Delta}, \\ \frac{U(1q_i, 2q_{j-1}, 3q_k, \dots, nq_z) - U(1q_i, 2q_{j+1}, 3q_k, \dots, nq_z)}{2\Delta}, \\ \frac{U(1q_i, 2q_j, 3q_{k-1}, \dots, nq_z) - U(1q_i, 2q_j, 3q_{k+1}, \dots, nq_z)}{2\Delta}, \\ \dots\dots\dots \\ \frac{U(1q_i, 2q_j, 3q_k, \dots, nq_{z-1}) - U(1q_i, 2q_j, 3q_k, \dots, nq_{z+1})}{2\Delta}, \end{array} \right)$$

where Δ is the distance between neighbours on the grid.

4.2.6 Manipulability Based Kinematic Conditioning Control

The kinematic conditioning control is achieved by optimising the manipulability metric of the robot. The value of the manipulability metric is directly dependent on the ability of the robot to generate forces and velocities and is used as a potential function for the kinematic conditioning defined over the configuration space spanned by the degrees of freedom of the bound input space of the controller instance. Control actions are here calculated by performing gradient ascent on the manipulability metric.

4.2.6.1 Manipulability Function

The manipulability metric w is,

$$w = \sqrt{\det(\mathbf{J}(\mathbf{q})\mathbf{J}^T(\mathbf{q}))}$$

where J denotes the Jacobian matrix and q denotes the configuration. The configuration vector is given by

$$q = [q_1, q_2, q_3, \dots, q_n]^T$$

and the position of the end effector is given by

$$r = [r_1, r_2, r_3, \dots, r_m]^T$$

where $m \leq n$. The relation between r and q is generally nonlinear and is given by

$$r = f_r(q)$$

This equation is the kinematic equation of the manipulator[9]. Using the Jacobian matrix, the end effector velocity could be expressed as

$$\dot{r} = J_r(q)\dot{q}$$

The Jacobian matrix of r with respect to q is

$$J_r(q) = \begin{bmatrix} \frac{\partial r_1}{\partial q_1} & \frac{\partial r_1}{\partial q_2} & \dots & \frac{\partial r_1}{\partial q_n} \\ \frac{\partial r_2}{\partial q_1} & \frac{\partial r_2}{\partial q_2} & \dots & \frac{\partial r_2}{\partial q_n} \\ \dots & \dots & & \dots \\ \frac{\partial r_m}{\partial q_1} & \frac{\partial r_m}{\partial q_2} & \dots & \frac{\partial r_m}{\partial q_n} \end{bmatrix}$$

The position of the end effector in the global coordinate system is obtained by using homogeneous transforms.

4.3 Control Composition

The composition policy for the controllers is task dependent. The task is divided into a sequence of control objectives. Each control objective translates into a concurrent activation of the bound controllers based on the composition policy. The

total control policy could then be a sequence of controller activations with transitions caused by convergence events.

The controllers have underlying generic control objectives which are associated with a set of actuators and sensors. The controllers are denoted by $\phi_i \frac{\sigma}{\tau}$, where ϕ_i is an element of the control basis and σ and τ denote the set of input and output resources. Concurrent activation is denoted by ”;” and constrained controllers are denoted by ”◁”. An example of control composition is shown below.

$$\left(\begin{matrix} \text{Base, Manipulator} \\ M \end{matrix} \phi_{\Theta_i, X_j}^{\theta_i, x_j} \right) \triangleleft \left(\begin{matrix} \text{Base} \\ H \end{matrix} \phi_{X_j}^{x_j} \right) \triangleleft \left(\left(\begin{matrix} \text{Manipulator} \\ H \end{matrix} \phi_{\Theta_i}^{\theta_i} \right); \left(\begin{matrix} \text{Manipulator} \\ M \end{matrix} \phi_{\Theta_i}^{\theta_i} \right) \right)$$

where ϕ is the controller M represents a manipulability based controller, H represents a harmonic function based controller, θ represents the joint angles, Θ represents the joint actuators, x represents the base location and X represents the base actuators on the mobile manipulator.

4.3.1 Constraints

The composition policy determines whether the output of a controller needs to be constrained. The controllers are activated concurrently based on the task dependent composition policy either in an asynchronous fashion or under the ”◁” constraint. The output of the controllers could be constrained to transform the output into a different space.

4.3.1.1 Parallel Composition Constraints

The lower level controllers can only operate in the areas which do not counteract the control objectives of the higher level controllers. The constraint on a lower level controller is enforced by mapping the output of the controller onto the control surface of the higher level controller. For example, the kinematic conditioning con-

troller could be constrained by the motion controller thereby ensuring that the robot maintains a certain position or velocity while improving its kinematic conditioning.

4.3.1.2 Constrained Jacobians

The output from the controllers could be transformed into a different space by using constrained Jacobians. This changes the output of the controller, changing the behaviour of the control composition. For example, in mobile manipulators, fixing the end effector to a certain point in Cartesian space relates the joint angles of the manipulator to the location of the mobile platform in Cartesian space. By using the constrained Jacobian, it is possible to direct the output of the motion controller of the manipulator to the mobile platform.

CHAPTER 5

IMPLEMENTATION AND EXPERIMENTS

The control basis method has been implemented on a mobile manipulator. Harmonic function path planners have been implemented as motion controllers. The motion controllers for the mobile platform and the manipulator are different instantiations of the motion control law as their control spaces are different. The manipulability function has been implemented as the kinematic conditioning controller. Different control compositions were developed based upon the tasks to be done. The control compositions were then implemented. The experiments were then performed and the results were observed.

5.1 Implementation

The mobile base of the robot is a Pioneer2 model. It has two degrees of freedom which are controlled by two reversible motors. It has a height of 21.5cm and is 38cm wide. It has a swing radius of 26cm.

The manipulator is a Robotica Edubot 250 arm with five degrees of freedom which are driven by servo motors that provide no external position feedback. The range is 50cm fully extended. In addition to the five degrees of freedom of the arm, it has a one degree of freedom gripper whose fingers can part 5cm. The payload is 150gm. The manipulator is mounted on top of the mobile base (Figure 5.1). For the experiments a dynamic simulator is used which was supplied by ActivMedia Robotics. Since the manipulator was not simulated in the basic simulator, a kinematic simulation for the manipulator was added into the existing simulator.



Figure 5.1. Mobile Manipulator.

The software is run on a computer with an Intel Pentium D processor with a speed of 3.2 GHz.

5.1.1 Controllers

5.1.1.1 Harmonic Function Path Planners

Harmonic function path planners are used for motion control. Applied to a configuration space for a subset of the degrees of freedom of the mobile manipulator a potential is calculated as a harmonic function. Calculating the gradient at a given point in this space determines the C-space vector for the robot to take to move towards the goal. As the harmonic function here works on the C-space of the robot, the robot itself is reduced to a point and obstacles and goals have to be converted into the C-space. The C-space is divided equally into a grid. The goals and obstacles are marked as grid cells. For these experiments two instances of the harmonic func-

tion motion controller have been implemented, one for the base and one for the arm, basically decomposing the platform into two substructures. The harmonic function for the manipulator and for the mobile base have been implemented separately. This is because this significantly reduces the complexity of the platform and also allows different position objectives to be pursued by the arm and the base. The particular division was chosen because the degrees of freedom of the manipulator and the mobile base are mostly independent. Constraints, both in terms of composition and constrained Jacobians, are used to tie the two spaces together. An artificial boundary is added to the grid to indicate the limits of the C-space and to relax the potential of the grid. All obstacles are set at the maximum potential (1) while the goals are at the minimum potential (0). The empty cells are initialised to a value of 0. The SOR function relaxes the grid until the residual value of the SOR is below the limit specified. The dimensionality of the mobile base grid is two. The platform is treated as holonomic and therefore the C-space dimensions correspond to the Cartesian coordinates of the environment. The size of the grid is 49 X 49, covering a real size of the world of 10m X 10m. The size of each cell is thus 0.204082m X 0.204082m. The dimensionality of the manipulator grid is five, corresponding to the five degrees of freedom of the arm. The size of the grid is 32 X 16 X 16 X 16 X 8. Each joint angle has a range from 0° to 180° which makes each grid cell 5.625° X 11.25° X 11.25° X 11.25° X 22.5°. Functions are used which can give the steepest gradient at a point in the grid or the range of gradients available at that point. Manipulator obstacles and goals in Cartesian space are converted to joint angle cells using lookup tables and are marked on the grid accordingly.

For marking goals and obstacles in joint angle space, lookup tables were computed to store joint angle configurations corresponding to a Cartesian location. The

total volume of the Cartesian space taken is $960\text{mm} \times 960\text{mm} \times 960\text{mm}$. This space is divided into cells of $10\text{mm} \times 10\text{mm} \times 10\text{mm}$. The location of a point in this space is indicated using the coordinate system of the base of the manipulator. For the joint angle space, the total volume is $180^\circ \times 180^\circ \times 180^\circ \times 180^\circ \times 180^\circ$. This space is divided into cells of $5.625^\circ \times 11.25^\circ \times 11.25^\circ \times 11.25^\circ \times 22.5^\circ$. The lookup table contains a list of the Cartesian cells. Each item on this list has a sublist of joint angle configurations. The Cartesian location of a point is computed by using forward kinematics with a joint angle configuration. The joint angle configuration is then stored in a sub-list which is again stored in the main list containing Cartesian locations.

For goals, the location of the end effector is calculated using a set of joint angle configurations using forward kinematics and then the joint angle configurations are stored in the list. For obstacles, all locations of the arm are calculated for a joint angle configuration.

The computation for the lookup tables was done on the Distributed and Parallel Computing Cluster at UTA.

Table 5.1. Lookup table format

x_1, y_1, z_1
sublist of joint angle configurations
x_2, y_2, z_2
sublist of joint angle configurations
\dots
\dots
x_n, y_n, z_n
sublist of joint angle configurations

5.1.1.2 Kinematic Conditioning Controller

The manipulability controller is used as a kinematic conditioning controller in the experiment. The manipulability metric can be analytically obtained from the determinant of the Jacobian matrix. The gradient for manipulability is computed around a certain joint angle configuration. One instance of the manipulability controller is used when it is bound to the five degrees of freedom of the arm as its input. It therefore operates on a five dimensional configuration space. The equations to convert a point in the end effector coordinate system to the global coordinate system are given in Appendix A.

5.1.2 Composition Constraints

The gradients around a point in the control space are computed and then sorted in an descending order. If a controller is "subject to" another controller then the gradients are transformed into the control space of the dominant controller. The difference in potentials are then calculated in the dominant controller's control space. If the change in control value is as per the controller's objective or if there is no change in control value then the gradient is accepted. The transformation from one control space to another is done using Jacobians. The transformation from joint angle space to Cartesian space is done using the Jacobian of the manipulator. The transformation from Cartesian space to joint angle space is done using the Jacobian Transpose. This transformation is also done using the inverse kinematics.

5.1.3 Sequential Composition

In sequential composition, the task is divided into simpler sub-tasks. A control composition for each of these sub-tasks is decided upon. The overall control becomes a sequence of control compositions each with a sub-goal.

5.2 Experiments

Two experiments have been performed to illustrate the robustness and flexibility of this approach to address different tasks.

5.2.1 Experiment 1

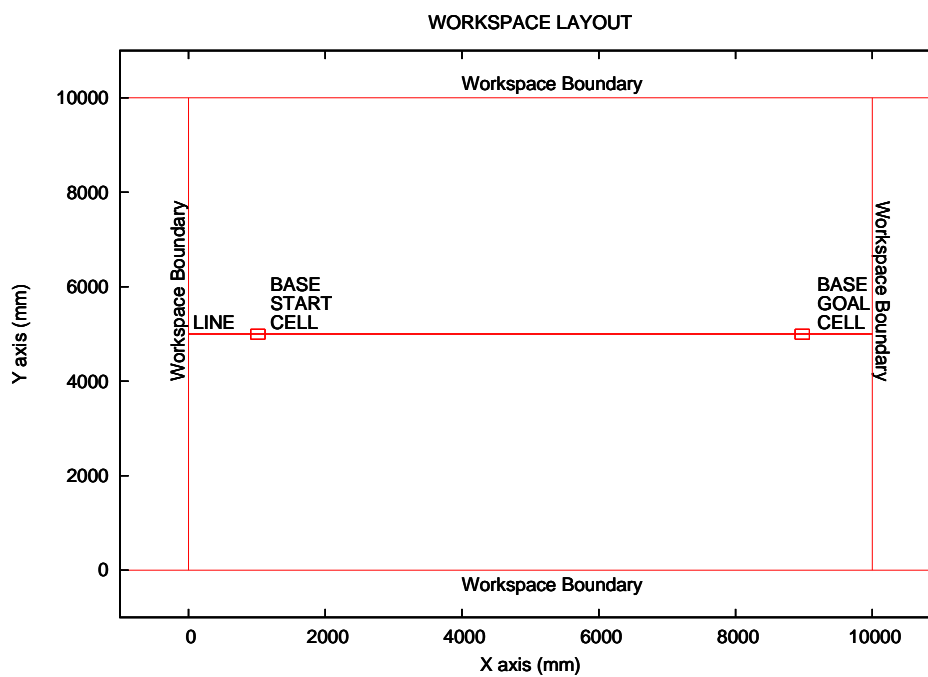

Figure 5.2. Workspace Layout.

In this task, (shown in Figure 5.2), the end effector of the mobile manipulator has to maintain a position on a given line in space while the base moves from point A

to point B. The end effector of the manipulator has a goal of maintaining a position on the given line irrespective of the position of the base. The base has a goal of moving from point A to point B.

5.2.2 Hierarchy of Controllers

As per the description, the primary task is for the end effector of the manipulator to maintain a position on a given line in space. The most effective controller for the end effector is the harmonic controller of the manipulator. This makes this controller the dominant controller. The secondary task is for the base to move from point A to point B. This is done by using the harmonic controller for the base. However, since the end effector has to maintain position, the base harmonic controller becomes "subject to" the manipulator harmonic controller. During the mobile manipulator's movement in the workspace, it is quite possible that the articulated structure of the mobile manipulator decreases its kinematic conditioning. A manipulability controller is added which tries to improve the kinematic conditioning of the mobile manipulator "subject to" both the arm harmonic and base harmonic controllers. This yields the following composition :

$$\left(\begin{matrix} Base, Manipulator \\ M \end{matrix} \phi^{\theta_i, X_j} \right) \triangleleft \left(\begin{matrix} Base \\ H \end{matrix} \phi^{X_j} \right) \triangleleft \left(\begin{matrix} Manipulator \\ H \end{matrix} \phi^{\theta_i} \right)$$

where M is the manipulability controller, H is the harmonic function controller, θ_i are the joint angles of the manipulator and X_j is the location in the world. The dominant controller in this task is the motion controller for the manipulator. The base is free to move in its configuration space as long as the manipulator can keep holding on to the line. The motion controller for the base is then "subject to" the motion controller of the arm. The kinematic conditioning controller will improve the articulated structure of the robot, improve the manipulability metric of the manipulator. This causes the

robot to be in a position from where it is possible to move in any direction easily. This prevents the robot from getting into a configuration from which it is impossible to move without exceeding the workspace of the manipulator. The manipulability controller is again "subject to" both the motion controllers of the base and the arm.

5.2.3 Constraints

The motion controller for the base moves the base. For a change in base location, the joint angles are to be adjusted such that the end effector of the manipulator stays on the line. The movements of the base are subject to the requirement that the joint angle changes keep the end effector on the line. The motion controller for the base is constrained to the motion controller for the manipulator by using inverse kinematics. For a given location in Cartesian space, the inverse kinematics gives joint angle configurations which will enable the end effector to reach that location. The base motion controller uses these values to maintain the manipulator on the line as well as move towards the goal. The manipulability controller is constrained to the motion controller of the manipulator by directly comparing the harmonic potential values of the new and old joint angles configurations. The manipulability controller is constrained to the motion controller of the base by using the Jacobian matrix to compute the effect of change in joint angles to change in location of the end effector. The change in location of the end effector is used to compare the harmonic potential values on the potential field of the motion controller of the base.

5.2.4 Results

Several runs of the robot within the simulator were done and the observations made. By composing the controllers, it was observed that the end effector follows the given line. Without the composition, the base follows the path with the max-

imum gradient from the starting point to the goal (the line labelled "Base without composition" on Figures 5.3 and 5.5).

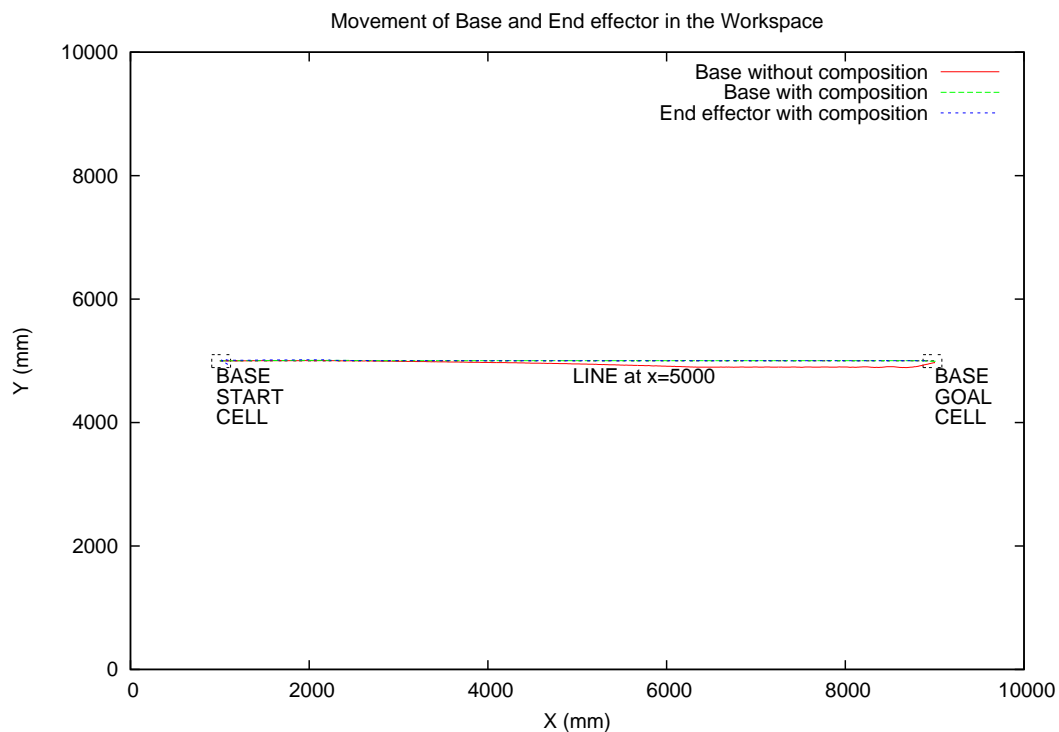

Figure 5.3. Movement of Base and End effector in the workspace.

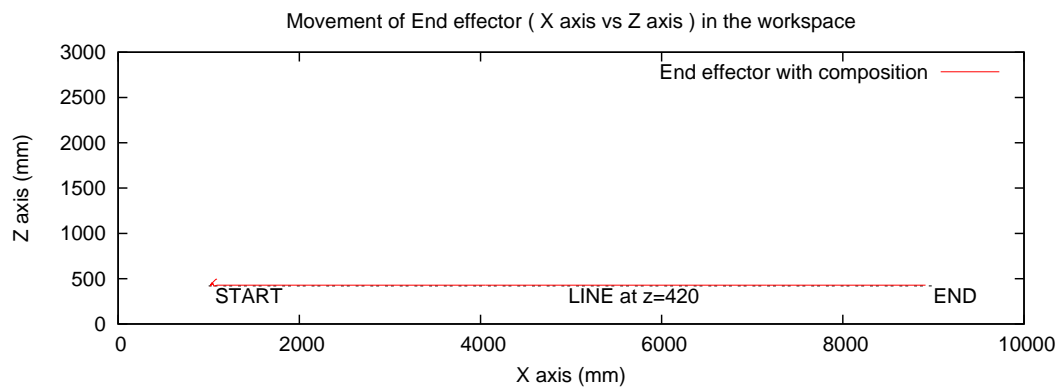

Figure 5.4. Movement of End effector (X axis vs Z axis).

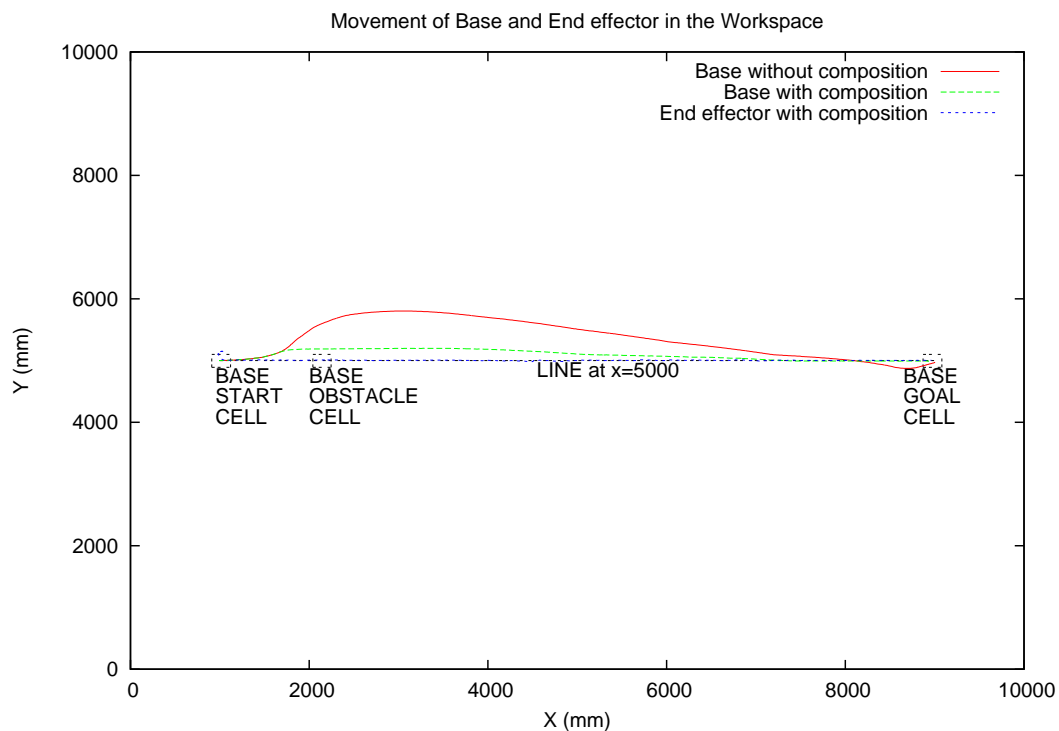

Figure 5.5. Movement of Base and End effector in the workspace with obstacle.

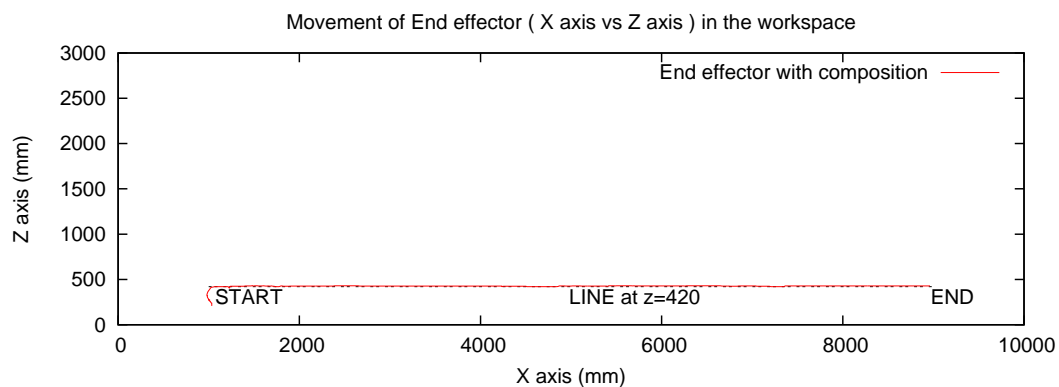

Figure 5.6. Movement of End effector (X axis vs Z axis) with obstacle.

With the composition, the base cannot follow the maximum gradient path because of the constraint. The end effector remains on the line (the line labelled "End

effector with composition” on Figures 5.3, 5.4, 5.5, 5.6). The base tries to follow the maximum gradient but is constrained by the arm controller. This changes the path of the base. Every position taken by the base is such that the line is always reachable by the arm (the line labelled ”Base with composition” on Figures 5.3 and 5.5) The two scenarios shown in Figures 5.3 and 5.5 also demonstrate the robustness and versatility of the composition to address different environments (e.g. the obstacle on the path in Figure 5.5) without the need for a modified composition.

5.2.5 Experiment 2

In this task, the mobile manipulator has to pick up an object and drop it off at the indicated location and then move back to the starting point.

5.2.6 Hierarchy of Controllers

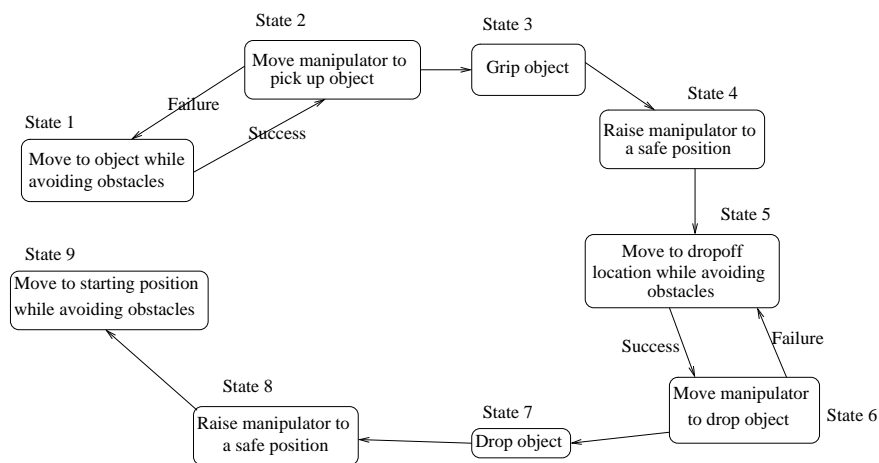

Figure 5.7. Sequential Composition.

This task can be divided into a sequence of sub-tasks as shown in Figure 5.7. The mobile manipulator has to move in the workspace while avoiding obstacles to

reach a sub-goal. Obstacles are of three types. Some obstacles affect the base while some affect the manipulator and some affect both base and the manipulator. Since the base moves the manipulator as it moves, the base can cause the manipulator to collide with an obstacle which only affects the manipulator. Since movements of the manipulator do not affect the location of the base, the manipulator cannot cause the base to collide with an obstacle. Therefore, for this sub-task, the harmonic controller for the manipulator is dominant with the harmonic controller for the base as the subservient one. The manipulator harmonic controller has only goals and obstacles. This makes it neutral to any joint angle configuration except if it is an obstacle. The base harmonic controller has goals and obstacles. The base harmonic controller will try to move the robot towards its sub-goal subject to the manipulator harmonic controller.

The next sub-task would be the manipulator getting in position to pick up object. In this sub-task, the manipulator harmonic controller will be able to achieve this sub-task.

The next sub-task would be for the gripper to pick up the object. This is achieved by using a simple contact controller for the gripper which closes the gripper jaws.

The next sub-task is for the manipulator to lift itself to a position such that it can carry the object without collisions with base obstacles. This is achieved by using the manipulator harmonic controller.

The next sub-task is for the robot to move to the designated drop off location. This can be done by reusing the first sub-task composition. The next sub-task is for the manipulator to get in drop off position. Again the second sub-task composition will achieve this sub-goal.

The next sub-task is for the gripper to drop the object. This is again done using the gripper controller to open the gripper jaws.

The next sub-task is for the manipulator to get into a position where it can safely avoid base obstacles. The manipulator harmonic controller is used to achieve this task.

The next sub-task is for the robot to move to the starting location. This can be done by reusing the first sub-task composition.

The whole sequence is displayed in Figure 5.7 and leads to the following composition :

$$\begin{aligned}
& ((Base \phi^{X_j}) \triangleleft (Manipulator \phi^{\theta_i})) \rightleftharpoons (Manipulator \phi^{\theta_i}) \rightarrow (Gripper \phi^{\theta_g}) \rightarrow \\
& (Manipulator \phi^{\theta_i}) \rightarrow ((Base \phi^{X_j}) \triangleleft (Manipulator \phi^{\theta_i})) \rightleftharpoons (Manipulator \phi^{\theta_i}) \rightarrow (Gripper \phi^{\theta_g}) \rightarrow \\
& (Manipulator \phi^{\theta_i}) \rightarrow ((Base \phi^{X_j}) \triangleleft (Manipulator \phi^{\theta_i}))
\end{aligned}$$

where M is the manipulability controller, H is the harmonic function controller, θ_i are the joint angles of the manipulator and X_j is the location in the world.

5.2.7 Constraints

The base harmonic controller is constrained by the manipulator harmonic controller. For a change in base location, the change in end effector location in joint angles is computed. The difference in potential is compared to check if the manipulator is close to an obstacle. If the potential increases then the move by the base is invalid. The other sub-tasks do not have constraints. However, the main controller has to check if the composition has converged. Upon convergence, the main controller moves the control to the next control composition.

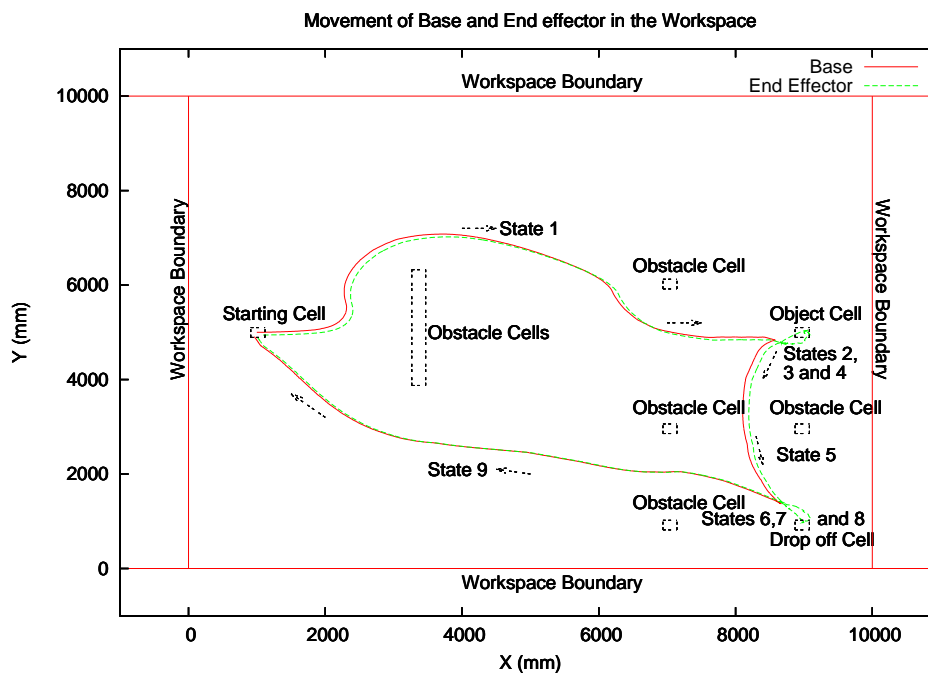

Figure 5.8. Movement of Base and End effector with obstacles (Experiment 2).

5.2.8 Results

The mobile manipulator is successfully able to pick up object from the object location, then drop the object at the drop off location and come back to the starting location (Figure 5.8).

CHAPTER 6

CONCLUSIONS AND FUTURE WORK

6.1 Conclusions

Mobile manipulators combine the capabilities of a robot arm with the mobility of a mobile platform. This significantly increases their work and task space, allowing them to address a wide range of tasks. This flexibility, however, also increases their complexity, making it difficult to achieve robust, flexible and predictable control using traditional control approaches. In this thesis, the Control Basis method is therefore applied to mobile manipulators. A set of basis control laws is first chosen. These elements of the control basis have generic control objectives. By associating the control laws with different sets of sensors and actuators, control is derived. The controllers are activated concurrently either asynchronously or under a "subject to" constraint. The control composition is task dependent and different tasks are achieved by different composition functions over the same basis controllers. In one example task e.g. the mobile manipulator is able to hold onto a line in space using its end effector while the base moves from one point to another. In addition to these parallel composition of objectives, the mobile manipulator also performs complex tasks by dividing them into simpler sub-tasks, each of which has its own control composition. Since the underlying control basis is kinematically independent, it is possible to use the same basis control laws on different platforms. By using the same set of controllers it is possible to accomplish a variety of tasks, thus the control basis method has a broad range of operating contexts. The control basis method is able to handle multiple goals as well as unstructured and uncertain environments. The stability and

robustness of the underlying control basis is inherited by the composition controllers making it a suitable framework for complex mobile manipulation platforms.

6.2 Future Work

With the present platform, different compositions could be designed around different tasks. Complex tasks can be divided into sequences of simpler sub tasks and compositions for each sub task could be designed and implemented. With more processing power and more memory on the hardware platform, the control cycle could be made faster, allowing for much finer control. Attention could be more focused on the design of composition of the controllers and on learning or planning.

APPENDIX A
MANIPULATOR EQUATIONS

A.1 Manipulator Kinematics

This appendix contains the transformation equations for the manipulator. The manipulator has five joints. It is mounted upon the base. The base can move around the world (Figure A.1). There are eight coordinate systems in which a point can be represented. The different coordinate systems are World, Base and Joints 1 to 5. Using the equations, the coordinates of a point represented in a coordinate system can be transformed into the coordinates of another coordinate system. The equations A.54, A.55 and A.56 transform a point expressed in the coordinate system of the end effector joint into a point expressed in the coordinate system of the manipulator base.



Figure A.1. Mobile Manipulator.

A.1.1 Base to World

0° - 360° rotation around Z axis

$$\begin{aligned} \begin{bmatrix} X \\ Y \\ Z \\ 1 \end{bmatrix} &= \begin{bmatrix} \cos \theta_g & -\sin \theta_g & 0 & X_g \\ \sin \theta_g & \cos \theta_g & 0 & Y_g \\ 0 & 0 & 1 & 0 \\ 0 & 0 & 0 & 1 \end{bmatrix} \begin{bmatrix} x \\ y \\ z \\ 1 \end{bmatrix} \\ &= \begin{bmatrix} x \cos \theta_g - y \sin \theta_g + X_g \\ x \sin \theta_g + y \cos \theta_g + Y_g \\ z \\ 1 \end{bmatrix} \end{aligned}$$

$$X = x \cos \theta_g - y \sin \theta_g + X_g \quad (\text{A.1})$$

$$Y = x \sin \theta_g + y \cos \theta_g + Y_g \quad (\text{A.2})$$

$$Z = z \quad (\text{A.3})$$

A.1.2 World to Base

$$\begin{bmatrix} X \\ Y \\ Z \\ 1 \end{bmatrix} = \begin{bmatrix} \cos \theta_g & \sin \theta_g & 0 & 0 \\ -\sin \theta_g & \cos \theta_g & 0 & 0 \\ 0 & 0 & 1 & 0 \\ 0 & 0 & 0 & 1 \end{bmatrix} \begin{bmatrix} 0 & 0 & 0 & -X_g \\ 0 & 0 & 0 & -Y_g \\ 0 & 0 & 1 & 0 \\ 0 & 0 & 0 & 1 \end{bmatrix} \begin{bmatrix} x \\ y \\ z \\ 1 \end{bmatrix}$$

$$\begin{aligned}
&= \begin{bmatrix} \cos \theta_g & \sin \theta_g & 0 & -X_g \cos \theta_g - Y_g \sin \theta_g \\ -\sin \theta_g & \cos \theta_g & 0 & X_g \sin \theta_g - Y_g \cos \theta_g \\ 0 & 0 & 1 & 0 \\ 0 & 0 & 0 & 1 \end{bmatrix} \begin{bmatrix} x \\ y \\ z \\ 1 \end{bmatrix} \\
&= \begin{bmatrix} x \cos \theta_g + y \sin \theta_g - X_g \cos \theta_g - Y_g \sin \theta_g \\ -x \sin \theta_g + y \cos \theta_g + X_g \sin \theta_g - Y_g \cos \theta_g \\ z \\ 1 \end{bmatrix}
\end{aligned}$$

$$X = x \cos \theta_g + y \sin \theta_g - X_g \cos \theta_g - Y_g \sin \theta_g \quad (\text{A.4})$$

$$Y = -x \sin \theta_g + y \cos \theta_g + X_g \sin \theta_g - Y_g \cos \theta_g \quad (\text{A.5})$$

$$Z = z \quad (\text{A.6})$$

A.1.3 Manipulator Base to Base

$$X = y + 125 \quad (\text{A.7})$$

$$Y = -x \quad (\text{A.8})$$

$$Z = z + 119.5 \quad (\text{A.9})$$

A.1.4 Base to Manipulator Base

$$X = -y \quad (\text{A.10})$$

$$Y = x - 125 \quad (\text{A.11})$$

$$Z = z - 119.5 \quad (\text{A.12})$$

A.1.5 Joint 1 to Manipulator Base

0° to 180° rotation around Z axis

$$\begin{bmatrix} X \\ Y \\ Z \\ 1 \end{bmatrix} = \begin{bmatrix} \cos \theta_1 & -\sin \theta_1 & 0 & 0 \\ \sin \theta_1 & \cos \theta_1 & 0 & 0 \\ 0 & 0 & 1 & 0 \\ 0 & 0 & 0 & 1 \end{bmatrix} \begin{bmatrix} x \\ y \\ z \\ 1 \end{bmatrix} = \begin{bmatrix} x \cos \theta_1 - y \sin \theta_1 \\ x \sin \theta_1 + y \cos \theta_1 \\ z \\ 1 \end{bmatrix}$$

$$X = x \cos \theta_1 - y \sin \theta_1 \quad (\text{A.13})$$

$$Y = x \sin \theta_1 + y \cos \theta_1 \quad (\text{A.14})$$

$$Z = z \quad (\text{A.15})$$

A.1.6 Manipulator Base to Joint 1

$$\begin{bmatrix} X \\ Y \\ Z \\ 1 \end{bmatrix} = \begin{bmatrix} \cos \theta_1 & \sin \theta_1 & 0 & 0 \\ -\sin \theta_1 & \cos \theta_1 & 0 & 0 \\ 0 & 0 & 1 & 0 \\ 0 & 0 & 0 & 1 \end{bmatrix} \begin{bmatrix} x \\ y \\ z \\ 1 \end{bmatrix} = \begin{bmatrix} x \cos \theta_1 + y \sin \theta_1 \\ -x \sin \theta_1 + y \cos \theta_1 \\ z \\ 1 \end{bmatrix}$$

$$X = x \cos \theta_1 + y \sin \theta_1 \quad (\text{A.16})$$

$$Y = -x \sin \theta_1 + y \cos \theta_1 \quad (\text{A.17})$$

$$Z = z \quad (\text{A.18})$$

A.1.7 Joint 2 to Joint 1

68.75mm translation on X axis, 72mm translation on Z axis, -135° rotation around Y axis, -90° around X axis, 0° to 180° around Z axis

$$\begin{aligned}
 & \begin{bmatrix} 1 & 0 & 0 & 68.75 \\ 0 & 1 & 0 & 0 \\ 0 & 0 & 1 & 72 \\ 0 & 0 & 0 & 1 \end{bmatrix} \begin{bmatrix} \cos(-135^\circ) & 0 & \sin(-135^\circ) & 0 \\ 0 & 1 & 0 & 0 \\ -\sin(-135^\circ) & 0 & \cos(-135^\circ) & 0 \\ 0 & 0 & 0 & 1 \end{bmatrix} \\
 & \begin{bmatrix} 1 & 0 & 0 & 0 \\ 0 & \cos(-90^\circ) & -\sin(-90^\circ) & 0 \\ 0 & \sin(-90^\circ) & \cos(-90^\circ) & 0 \\ 0 & 0 & 0 & 1 \end{bmatrix} \begin{bmatrix} \cos \theta_2 & -\sin \theta_2 & 0 & 0 \\ \sin \theta_2 & \cos \theta_2 & 0 & 0 \\ 0 & 0 & 1 & 0 \\ 0 & 0 & 0 & 1 \end{bmatrix} = \\
 & \begin{bmatrix} 1 & 0 & 0 & 68.75 \\ 0 & 1 & 0 & 0 \\ 0 & 0 & 1 & 72 \\ 0 & 0 & 0 & 1 \end{bmatrix} \begin{bmatrix} -\frac{1}{\sqrt{2}} & 0 & -\frac{1}{\sqrt{2}} & 0 \\ 0 & 1 & 0 & 0 \\ \frac{1}{\sqrt{2}} & 0 & -\frac{1}{\sqrt{2}} & 0 \\ 0 & 0 & 0 & 1 \end{bmatrix} \begin{bmatrix} 1 & 0 & 0 & 0 \\ 0 & 0 & 1 & 0 \\ 0 & -1 & 0 & 0 \\ 0 & 0 & 0 & 1 \end{bmatrix} \begin{bmatrix} \cos \theta_2 & -\sin \theta_2 & 0 & 0 \\ \sin \theta_2 & \cos \theta_2 & 0 & 0 \\ 0 & 0 & 1 & 0 \\ 0 & 0 & 0 & 1 \end{bmatrix} = \\
 & \begin{bmatrix} -\frac{1}{\sqrt{2}} & \frac{1}{\sqrt{2}} & 0 & 68.75 \\ 0 & 0 & 1 & 0 \\ \frac{1}{\sqrt{2}} & \frac{1}{\sqrt{2}} & 0 & 72 \\ 0 & 0 & 0 & 1 \end{bmatrix} \begin{bmatrix} \cos \theta_2 & -\sin \theta_2 & 0 & 0 \\ \sin \theta_2 & \cos \theta_2 & 0 & 0 \\ 0 & 0 & 1 & 0 \\ 0 & 0 & 0 & 1 \end{bmatrix} = \\
 & \begin{bmatrix} -\frac{1}{\sqrt{2}} \cos \theta_2 + \frac{1}{\sqrt{2}} \sin \theta_2 & \frac{1}{\sqrt{2}} \sin \theta_2 + \frac{1}{\sqrt{2}} \cos \theta_2 & 0 & 68.75 \\ 0 & 0 & 1 & 0 \\ \frac{1}{\sqrt{2}} \cos \theta_2 + \frac{1}{\sqrt{2}} \sin \theta_2 & -\frac{1}{\sqrt{2}} \sin \theta_2 + \frac{1}{\sqrt{2}} \cos \theta_2 & 0 & 72 \\ 0 & 0 & 0 & 1 \end{bmatrix}
 \end{aligned}$$

$$\alpha = \frac{1}{\sqrt{2}} \sin \theta_2 - \frac{1}{\sqrt{2}} \cos \theta_2 \quad (\text{A.19})$$

$$\beta = \frac{1}{\sqrt{2}} \sin \theta_2 + \frac{1}{\sqrt{2}} \cos \theta_2 \quad (\text{A.20})$$

$$\begin{bmatrix} X \\ Y \\ Z \\ 1 \end{bmatrix} = \begin{bmatrix} \alpha & \beta & 0 & 68.75 \\ 0 & 0 & 1 & 0 \\ \beta & -\alpha & 0 & 72 \\ 0 & 0 & 0 & 1 \end{bmatrix} \begin{bmatrix} x \\ y \\ z \\ 1 \end{bmatrix} = \begin{bmatrix} x\alpha + y\beta + 68.75 \\ z \\ x\beta - y\alpha + 72 \\ 1 \end{bmatrix}$$

$$X = x\alpha + y\beta + 68.75 \quad (\text{A.21})$$

$$Y = z \quad (\text{A.22})$$

$$Z = x\beta - y\alpha + 72 \quad (\text{A.23})$$

A.1.8 Joint 1 to Joint 2

$$\begin{bmatrix} X \\ Y \\ Z \\ 1 \end{bmatrix} = \begin{bmatrix} \alpha & 0 & \beta & 0 \\ \beta & 0 & -\alpha & 0 \\ 0 & 1 & 0 & 0 \\ 0 & 0 & 0 & 1 \end{bmatrix} \begin{bmatrix} 0 & 0 & 0 & -68.75 \\ 0 & 1 & 0 & 0 \\ 0 & 0 & 1 & -72 \\ 0 & 0 & 0 & 1 \end{bmatrix} \begin{bmatrix} x \\ y \\ z \\ 1 \end{bmatrix} \\ = \begin{bmatrix} \alpha & 0 & \beta & -68.75\alpha - 72\beta \\ \beta & 0 & -\alpha & -68.75\beta + 72\alpha \\ 0 & 1 & 0 & 0 \\ 0 & 0 & 0 & 1 \end{bmatrix} \begin{bmatrix} x \\ y \\ z \\ 1 \end{bmatrix} = \begin{bmatrix} x\alpha + z\beta - 68.75\alpha - 72\beta \\ x\beta - z\alpha - 68.75\beta + 72\alpha \\ y \\ 1 \end{bmatrix}$$

$$X = x\alpha + z\beta - 68.75\alpha - 72\beta \quad (\text{A.24})$$

$$Y = x\beta - z\alpha - 68.75\beta + 72\alpha \quad (\text{A.25})$$

$$Z = y \quad (\text{A.26})$$

A.1.9 Joint 3 to Joint 2

160mm translation on X axis, -90° rotation around Z axis, 0° to 180° around

Z axis

$$\begin{aligned}
 & \begin{bmatrix} 1 & 0 & 0 & 160 \\ 0 & 1 & 0 & 0 \\ 0 & 0 & 1 & 0 \\ 0 & 0 & 0 & 1 \end{bmatrix} \begin{bmatrix} \cos(-90^\circ) & -\sin(-90^\circ) & 0 & 0 \\ \sin(-90^\circ) & \cos(-90^\circ) & 0 & 0 \\ 0 & 0 & 1 & 0 \\ 0 & 0 & 0 & 1 \end{bmatrix} \begin{bmatrix} \cos \theta_3 & -\sin \theta_3 & 0 & 0 \\ \sin \theta_3 & \cos \theta_3 & 0 & 0 \\ 0 & 0 & 1 & 0 \\ 0 & 0 & 0 & 1 \end{bmatrix} = \\
 & \begin{bmatrix} 1 & 0 & 0 & 160 \\ 0 & 1 & 0 & 0 \\ 0 & 0 & 1 & 0 \\ 0 & 0 & 0 & 1 \end{bmatrix} \begin{bmatrix} 0 & 1 & 0 & 0 \\ -1 & 0 & 0 & 0 \\ 0 & 0 & 1 & 0 \\ 0 & 0 & 0 & 1 \end{bmatrix} \begin{bmatrix} \cos \theta_3 & -\sin \theta_3 & 0 & 0 \\ \sin \theta_3 & \cos \theta_3 & 0 & 0 \\ 0 & 0 & 1 & 0 \\ 0 & 0 & 0 & 1 \end{bmatrix} = \\
 & \begin{bmatrix} 0 & 1 & 0 & 160 \\ -1 & 0 & 0 & 0 \\ 0 & 0 & 1 & 0 \\ 0 & 0 & 0 & 1 \end{bmatrix} \begin{bmatrix} \cos \theta_3 & -\sin \theta_3 & 0 & 0 \\ \sin \theta_3 & \cos \theta_3 & 0 & 0 \\ 0 & 0 & 1 & 0 \\ 0 & 0 & 0 & 1 \end{bmatrix} = \begin{bmatrix} \sin \theta_3 & \cos \theta_3 & 0 & 160 \\ -\cos \theta_3 & \sin \theta_3 & 0 & 0 \\ 0 & 0 & 1 & 0 \\ 0 & 0 & 0 & 1 \end{bmatrix} \\
 & \begin{bmatrix} X \\ Y \\ Z \\ 1 \end{bmatrix} = \begin{bmatrix} \sin \theta_3 & \cos \theta_3 & 0 & 160 \\ -\cos \theta_3 & \sin \theta_3 & 0 & 0 \\ 0 & 0 & 1 & 0 \\ 0 & 0 & 0 & 1 \end{bmatrix} \begin{bmatrix} x \\ y \\ z \\ 1 \end{bmatrix} = \begin{bmatrix} x \sin \theta_3 + y \cos \theta_3 + 160 \\ -x \cos \theta_3 + y \sin \theta_3 \\ z \\ 1 \end{bmatrix}
 \end{aligned}$$

$$X = x \sin \theta_3 + y \cos \theta_3 + 160 \quad (\text{A.27})$$

$$Y = -x \cos \theta_3 + y \sin \theta_3 \quad (\text{A.28})$$

$$Z = z \quad (\text{A.29})$$

A.1.10 Joint 2 to Joint 3

$$\begin{aligned}
\begin{bmatrix} X \\ Y \\ Z \\ 1 \end{bmatrix} &= \begin{bmatrix} \sin \theta_3 & -\cos \theta_3 & 0 & 0 \\ \cos \theta_3 & \sin \theta_3 & 0 & 0 \\ 0 & 0 & 1 & 0 \\ 0 & 0 & 0 & 1 \end{bmatrix} \begin{bmatrix} 0 & 0 & 0 & -160 \\ 0 & 1 & 0 & 0 \\ 0 & 0 & 1 & 0 \\ 0 & 0 & 0 & 1 \end{bmatrix} \begin{bmatrix} x \\ y \\ z \\ 1 \end{bmatrix} \\
&= \begin{bmatrix} \sin \theta_3 & -\cos \theta_3 & 0 & -160 \sin \theta_3 \\ \cos \theta_3 & \sin \theta_3 & 0 & -160 \cos \theta_3 \\ 0 & 0 & 1 & 0 \\ 0 & 0 & 0 & 1 \end{bmatrix} \begin{bmatrix} x \\ y \\ z \\ 1 \end{bmatrix} \\
&= \begin{bmatrix} x \sin \theta_3 - y \cos \theta_3 - 160 \sin \theta_3 \\ x \cos \theta_3 + y \sin \theta_3 - 160 \cos \theta_3 \\ z \\ 1 \end{bmatrix}
\end{aligned}$$

$$X = x \sin \theta_3 - y \cos \theta_3 - 160 \sin \theta_3 \quad (\text{A.30})$$

$$Y = x \cos \theta_3 + y \sin \theta_3 - 160 \cos \theta_3 \quad (\text{A.31})$$

$$Z = z \quad (\text{A.32})$$

A.1.11 Joint 4 to Joint 3

92mm translation on X axis, 90° rotation around Y axis, 0° to 180° rotation around Z axis

$$\begin{aligned}
 & \begin{bmatrix} 1 & 0 & 0 & 92 \\ 0 & 1 & 0 & 0 \\ 0 & 0 & 1 & 0 \\ 0 & 0 & 0 & 1 \end{bmatrix} \begin{bmatrix} \cos(90^\circ) & 0 & \sin(90^\circ) & 0 \\ 0 & 1 & 0 & 0 \\ -\sin(90^\circ) & 0 & \cos(90^\circ) & 0 \\ 0 & 0 & 0 & 1 \end{bmatrix} \begin{bmatrix} \cos \theta_4 & -\sin \theta_4 & 0 & 0 \\ \sin \theta_4 & \cos \theta_4 & 0 & 0 \\ 0 & 0 & 1 & 0 \\ 0 & 0 & 0 & 1 \end{bmatrix} = \\
 & \begin{bmatrix} 1 & 0 & 0 & 92 \\ 0 & 1 & 0 & 0 \\ 0 & 0 & 1 & 0 \\ 0 & 0 & 0 & 1 \end{bmatrix} \begin{bmatrix} 0 & 0 & 1 & 0 \\ 0 & 1 & 0 & 0 \\ -1 & 0 & 0 & 0 \\ 0 & 0 & 0 & 1 \end{bmatrix} \begin{bmatrix} \cos \theta_4 & -\sin \theta_4 & 0 & 0 \\ \sin \theta_4 & \cos \theta_4 & 0 & 0 \\ 0 & 0 & 1 & 0 \\ 0 & 0 & 0 & 1 \end{bmatrix} = \\
 & \begin{bmatrix} 0 & 0 & 1 & 92 \\ 0 & 1 & 0 & 0 \\ -1 & 0 & 0 & 0 \\ 0 & 0 & 0 & 1 \end{bmatrix} \begin{bmatrix} \cos \theta_4 & -\sin \theta_4 & 0 & 0 \\ \sin \theta_4 & \cos \theta_4 & 0 & 0 \\ 0 & 0 & 1 & 0 \\ 0 & 0 & 0 & 1 \end{bmatrix} = \\
 & \begin{bmatrix} 0 & 0 & 1 & 92 \\ \sin \theta_4 & \cos \theta_4 & 0 & 0 \\ -\cos \theta_4 & \sin \theta_4 & 0 & 0 \\ 0 & 0 & 0 & 1 \end{bmatrix} \\
 & \begin{bmatrix} X \\ Y \\ Z \\ 1 \end{bmatrix} = \begin{bmatrix} 0 & 0 & 1 & 92 \\ \sin \theta_4 & \cos \theta_4 & 0 & 0 \\ -\cos \theta_4 & \sin \theta_4 & 0 & 0 \\ 0 & 0 & 0 & 1 \end{bmatrix} \begin{bmatrix} x \\ y \\ z \\ 1 \end{bmatrix} = \begin{bmatrix} z + 92 \\ x \sin \theta_4 + y \cos \theta_4 \\ -x \cos \theta_4 + y \sin \theta_4 \\ 1 \end{bmatrix}
 \end{aligned}$$

$$X = z + 92 \quad (\text{A.33})$$

$$Y = x \sin \theta_4 + y \cos \theta_4 \quad (\text{A.34})$$

$$Z = -x \cos \theta_4 + y \sin \theta_4 \quad (\text{A.35})$$

A.1.12 Joint 3 to Joint 4

$$\begin{aligned} \begin{bmatrix} X \\ Y \\ Z \\ 1 \end{bmatrix} &= \begin{bmatrix} 0 & \sin \theta_4 & -\cos \theta_4 & 0 \\ 0 & \cos \theta_4 & \sin \theta_4 & 0 \\ 1 & 0 & 0 & 0 \\ 0 & 0 & 0 & 1 \end{bmatrix} \begin{bmatrix} 1 & 0 & 0 & -92 \\ 0 & 1 & 0 & 0 \\ 0 & 0 & 1 & 0 \\ 0 & 0 & 0 & 1 \end{bmatrix} \begin{bmatrix} x \\ y \\ z \\ 1 \end{bmatrix} \\ &= \begin{bmatrix} 0 & \sin \theta_4 & -\cos \theta_4 & 0 \\ 0 & \cos \theta_4 & \sin \theta_4 & 0 \\ 1 & 0 & 0 & -92 \\ 0 & 0 & 0 & 1 \end{bmatrix} \begin{bmatrix} x \\ y \\ z \\ 1 \end{bmatrix} \\ &= \begin{bmatrix} y \sin \theta_4 - z \cos \theta_4 \\ y \cos \theta_4 + z \sin \theta_4 \\ x - 92 \\ 1 \end{bmatrix} \end{aligned}$$

$$X = y \sin \theta_4 - z \cos \theta_4 \quad (\text{A.36})$$

$$Y = y \cos \theta_4 + z \sin \theta_4 \quad (\text{A.37})$$

$$Z = x - 92 \quad (\text{A.38})$$

A.1.13 Joint 5 to Joint 4

45.75mm translation on Z axis, 90° rotation around X axis, 0° to 180° rotation around Z axis

$$\begin{aligned}
 & \begin{bmatrix} 1 & 0 & 0 & 0 \\ 0 & 1 & 0 & 0 \\ 0 & 0 & 1 & 45.75 \\ 0 & 0 & 0 & 1 \end{bmatrix} \begin{bmatrix} 1 & 0 & 0 & 0 \\ 0 & \cos(90^\circ) & -\sin(90^\circ) & 0 \\ 0 & \sin(90^\circ) & \cos(90^\circ) & 0 \\ 0 & 0 & 0 & 1 \end{bmatrix} \begin{bmatrix} \cos \theta_5 & -\sin \theta_5 & 0 & 0 \\ \sin \theta_5 & \cos \theta_5 & 0 & 0 \\ 0 & 0 & 1 & 0 \\ 0 & 0 & 0 & 1 \end{bmatrix} = \\
 & \begin{bmatrix} 1 & 0 & 0 & 0 \\ 0 & 1 & 0 & 0 \\ 0 & 0 & 1 & 45.75 \\ 0 & 0 & 0 & 1 \end{bmatrix} \begin{bmatrix} 1 & 0 & 0 & 0 \\ 0 & 0 & -1 & 0 \\ 0 & 1 & 0 & 0 \\ 0 & 0 & 0 & 1 \end{bmatrix} \begin{bmatrix} \cos \theta_5 & -\sin \theta_5 & 0 & 0 \\ \sin \theta_5 & \cos \theta_5 & 0 & 0 \\ 0 & 0 & 1 & 0 \\ 0 & 0 & 0 & 1 \end{bmatrix} = \\
 & \begin{bmatrix} 1 & 0 & 0 & 0 \\ 0 & 0 & -1 & 0 \\ 0 & 1 & 0 & 45.75 \\ 0 & 0 & 0 & 1 \end{bmatrix} \begin{bmatrix} \cos \theta_5 & -\sin \theta_5 & 0 & 0 \\ \sin \theta_5 & \cos \theta_5 & 0 & 0 \\ 0 & 0 & 1 & 0 \\ 0 & 0 & 0 & 1 \end{bmatrix} = \\
 & \begin{bmatrix} \cos \theta_5 & -\sin \theta_5 & 0 & 0 \\ 0 & 0 & -1 & 0 \\ \sin \theta_5 & \cos \theta_5 & 0 & 45.75 \\ 0 & 0 & 0 & 1 \end{bmatrix} \\
 & \begin{bmatrix} X \\ Y \\ Z \\ 1 \end{bmatrix} = \begin{bmatrix} \cos \theta_5 & -\sin \theta_5 & 0 & 0 \\ 0 & 0 & -1 & 0 \\ \sin \theta_5 & \cos \theta_5 & 0 & 45.75 \\ 0 & 0 & 0 & 1 \end{bmatrix} \begin{bmatrix} x \\ y \\ z \\ 1 \end{bmatrix} = \begin{bmatrix} x \cos \theta_5 - y \sin \theta_5 \\ -z \\ x \sin \theta_5 + y \cos \theta_5 + 45.75 \\ 1 \end{bmatrix}
 \end{aligned}$$

$$X = x \cos \theta_5 - y \sin \theta_5 \quad (\text{A.39})$$

$$Y = -z \quad (\text{A.40})$$

$$Z = x \sin \theta_5 + y \cos \theta_5 + 45.75 \quad (\text{A.41})$$

A.1.14 Joint 4 to Joint 5

$$\begin{aligned} \begin{bmatrix} X \\ Y \\ Z \\ 1 \end{bmatrix} &= \begin{bmatrix} \cos \theta_5 & 0 & \sin \theta_5 & 0 \\ -\sin \theta_5 & 0 & \cos \theta_5 & 0 \\ 0 & -1 & 0 & 0 \\ 0 & 0 & 0 & 1 \end{bmatrix} \begin{bmatrix} 1 & 0 & 0 & 0 \\ 0 & 1 & 0 & 0 \\ 0 & 0 & 1 & -45.75 \\ 0 & 0 & 0 & 1 \end{bmatrix} \begin{bmatrix} x \\ y \\ z \\ 1 \end{bmatrix} \\ &= \begin{bmatrix} \cos \theta_5 & 0 & \sin \theta_5 & -45.75 \sin \theta_5 \\ -\sin \theta_5 & 0 & \cos \theta_5 & -45.75 \cos \theta_5 \\ 0 & -1 & 0 & 0 \\ 0 & 0 & 0 & 1 \end{bmatrix} \begin{bmatrix} x \\ y \\ z \\ 1 \end{bmatrix} \\ &= \begin{bmatrix} x \cos \theta_5 + z \sin \theta_5 - 45.75 \sin \theta_5 \\ -x \sin \theta_5 + z \cos \theta_5 - 45.75 \cos \theta_5 \\ -y \\ 1 \end{bmatrix} \end{aligned}$$

$$X = x \cos \theta_5 + z \sin \theta_5 - 45.75 \sin \theta_5 \quad (\text{A.42})$$

$$Y = -x \sin \theta_5 + z \cos \theta_5 - 45.75 \cos \theta_5 \quad (\text{A.43})$$

$$Z = -y \quad (\text{A.44})$$

A.1.15 Joint 5 to Joint 3

Substituting equations A.39, A.40 and A.41 in equations A.33, A.34 and A.35,

$$X = z + 92$$

$$X = x \sin \theta_5 + y \cos \theta_5 + 45.75 + 92$$

$$X = x \sin \theta_5 + y \cos \theta_5 + 137.75 \quad (\text{A.45})$$

$$Y = x \sin \theta_4 + y \cos \theta_4$$

$$Y = (x \cos \theta_5 - y \sin \theta_5) \sin \theta_4 + (-z) \cos \theta_4$$

$$Y = x \cos \theta_5 \sin \theta_4 - y \sin \theta_5 \sin \theta_4 - z \cos \theta_4 \quad (\text{A.46})$$

$$Z = -x \cos \theta_4 + y \sin \theta_4$$

$$Z = -(x \cos \theta_5 - y \sin \theta_5) \cos \theta_4 + (-z) \sin \theta_4$$

$$Z = -x \cos \theta_5 \cos \theta_4 + y \sin \theta_5 \cos \theta_4 - z \sin \theta_4 \quad (\text{A.47})$$

A.1.16 Joint 5 to Joint 2

Substituting equations A.45, A.46 and A.47 in equations A.27, A.28 and A.29,

$$X = x \sin \theta_3 + y \cos \theta_3 + 160$$

$$X = (x \sin \theta_5 + y \cos \theta_5 + 137.75) \sin \theta_3 +$$

$$(x \cos \theta_5 \sin \theta_4 - y \sin \theta_5 \sin \theta_4 - z \cos \theta_4) \cos \theta_3 + 160$$

$$X = x \sin \theta_5 \sin \theta_3 + y \cos \theta_5 \sin \theta_3 + 137.75 \sin \theta_3 + x \cos \theta_5 \sin \theta_4 \cos \theta_3$$

$$- y \sin \theta_5 \sin \theta_4 \cos \theta_3 - z \cos \theta_4 \cos \theta_3 + 160$$

$$\begin{aligned}
X &= (\sin \theta_5 \sin \theta_3 + \cos \theta_5 \sin \theta_4 \cos \theta_3) x \\
&\quad + (\cos \theta_5 \sin \theta_3 - \sin \theta_5 \sin \theta_4 \cos \theta_3) y \\
&\quad - z \cos \theta_4 \cos \theta_3 \\
&\quad + 137.75 \sin \theta_3 + 160
\end{aligned} \tag{A.48}$$

$$Y = -x \cos \theta_3 + y \sin \theta_3$$

$$Y = -(x \sin \theta_5 + y \cos \theta_5 + 137.75) \cos \theta_3$$

$$+ (x \cos \theta_5 \sin \theta_4 - y \sin \theta_5 \sin \theta_4 - z \cos \theta_4) \sin \theta_3$$

$$Y = -x \sin \theta_5 \cos \theta_3 - y \cos \theta_5 \cos \theta_3 - 137.75 \cos \theta_3$$

$$+ x \cos \theta_5 \sin \theta_4 \sin \theta_3 - y \sin \theta_5 \sin \theta_4 \sin \theta_3 - z \cos \theta_4 \sin \theta_3$$

$$\begin{aligned}
Y &= (\cos \theta_5 \sin \theta_4 \sin \theta_3 - \sin \theta_5 \cos \theta_3) x \\
&\quad - (\sin \theta_5 \sin \theta_4 \sin \theta_3 + \cos \theta_5 \cos \theta_3) y \\
&\quad - z \cos \theta_4 \sin \theta_3 \\
&\quad - 137.75 \cos \theta_3
\end{aligned} \tag{A.49}$$

$$Z = z$$

$$Z = -x \cos \theta_5 \cos \theta_4 + y \sin \theta_5 \cos \theta_4 - z \sin \theta_4 \tag{A.50}$$

A.1.17 Joint 5 to Joint 1

Substituting equations A.48, A.49 and A.50 in equations A.21, A.22 and A.23,

$$X = x\alpha + y\beta + 68.75$$

$$\begin{aligned}
 X &= \left\{ \begin{array}{l} \left(\begin{array}{l} (\sin \theta_5 \sin \theta_3 + \cos \theta_5 \sin \theta_4 \cos \theta_3) x \\ + (\cos \theta_5 \sin \theta_3 - \sin \theta_5 \sin \theta_4 \cos \theta_3) y \\ - z \cos \theta_4 \cos \theta_3 \\ + 137.75 \sin \theta_3 + 160 \end{array} \right) \alpha \\ + \left(\begin{array}{l} (\cos \theta_5 \sin \theta_4 \sin \theta_3 - \sin \theta_5 \cos \theta_3) x \\ - (\sin \theta_5 \sin \theta_4 \sin \theta_3 + \cos \theta_5 \cos \theta_3) y \\ - z \cos \theta_4 \sin \theta_3 \\ - 137.75 \cos \theta_3 \end{array} \right) \beta + 68.75 \end{array} \right. \\
 X &= \left\{ \begin{array}{l} \left(\begin{array}{l} (\sin \theta_5 \sin \theta_3 \alpha + \cos \theta_5 \sin \theta_4 \cos \theta_3 \alpha) x \\ + (\cos \theta_5 \sin \theta_3 \alpha - \sin \theta_5 \sin \theta_4 \cos \theta_3 \alpha) y \\ - z \cos \theta_4 \cos \theta_3 \alpha \\ + 137.75 \sin \theta_3 \alpha + 160 \alpha \end{array} \right) \\ + \left(\begin{array}{l} (\cos \theta_5 \sin \theta_4 \sin \theta_3 \beta - \sin \theta_5 \cos \theta_3 \beta) x \\ - (\sin \theta_5 \sin \theta_4 \sin \theta_3 \beta + \cos \theta_5 \cos \theta_3 \beta) y \\ - z \cos \theta_4 \sin \theta_3 \beta \\ - 137.75 \cos \theta_3 \beta \end{array} \right) + 68.75 \end{array} \right. \\
 X &= \left\{ \begin{array}{l} \left(\begin{array}{ll} \sin \theta_5 \sin \theta_3 \alpha & + \cos \theta_5 \sin \theta_4 \cos \theta_3 \alpha \\ + \cos \theta_5 \sin \theta_4 \sin \theta_3 \beta & - \sin \theta_5 \cos \theta_3 \beta \end{array} \right) x \\ + \left(\begin{array}{ll} \cos \theta_5 \sin \theta_3 \alpha & - \sin \theta_5 \sin \theta_4 \cos \theta_3 \alpha \\ - \sin \theta_5 \sin \theta_4 \sin \theta_3 \beta & - \cos \theta_5 \cos \theta_3 \beta \end{array} \right) y \\ - \left(\begin{array}{ll} \cos \theta_4 \cos \theta_3 \alpha & + \cos \theta_4 \sin \theta_3 \beta \end{array} \right) z \\ + 137.75 \sin \theta_3 \alpha + 160 \alpha - 137.75 \cos \theta_3 \beta + 68.75 \end{array} \right. \quad (A.51)
 \end{aligned}$$

$$Y = z$$

$$Y = -x \cos \theta_5 \cos \theta_4 + y \sin \theta_5 \cos \theta_4 - z \sin \theta_4 \quad (\text{A.52})$$

$$Z = x\beta - y\alpha + 72$$

$$Z = \left\{ \begin{array}{l} \left(\begin{array}{l} (\sin \theta_5 \sin \theta_3 + \cos \theta_5 \sin \theta_4 \cos \theta_3) x \\ + (\cos \theta_5 \sin \theta_3 - \sin \theta_5 \sin \theta_4 \cos \theta_3) y \\ - z \cos \theta_4 \cos \theta_3 \\ + 137.75 \sin \theta_3 + 160 \end{array} \right) \beta \\ - \left(\begin{array}{l} (\cos \theta_5 \sin \theta_4 \sin \theta_3 - \sin \theta_5 \cos \theta_3) x \\ - (\sin \theta_5 \sin \theta_4 \sin \theta_3 + \cos \theta_5 \cos \theta_3) y \\ - z \cos \theta_4 \sin \theta_3 \\ - 137.75 \cos \theta_3 \end{array} \right) \alpha \\ + 72 \end{array} \right.$$

$$Z = \left\{ \begin{array}{l} \left(\begin{array}{l} (\sin \theta_5 \sin \theta_3 \beta + \cos \theta_5 \sin \theta_4 \cos \theta_3 \beta) x \\ + (\cos \theta_5 \sin \theta_3 \beta - \sin \theta_5 \sin \theta_4 \cos \theta_3 \beta) y \\ - z \cos \theta_4 \cos \theta_3 \beta \\ + 137.75 \sin \theta_3 \beta + 160 \beta \end{array} \right) \\ - \left(\begin{array}{l} (\cos \theta_5 \sin \theta_4 \sin \theta_3 \alpha - \sin \theta_5 \cos \theta_3 \alpha) x \\ - (\sin \theta_5 \sin \theta_4 \sin \theta_3 \alpha + \cos \theta_5 \cos \theta_3 \alpha) y \\ - z \cos \theta_4 \sin \theta_3 \alpha \\ - 137.75 \cos \theta_3 \alpha \end{array} \right) \\ + 72 \end{array} \right.$$

$$Z = \left\{ \begin{array}{l} \left(\begin{array}{cc} \sin \theta_5 \sin \theta_3 \beta & + \cos \theta_5 \sin \theta_4 \cos \theta_3 \beta \\ - \cos \theta_5 \sin \theta_4 \sin \theta_3 \alpha & + \sin \theta_5 \cos \theta_3 \alpha \end{array} \right) x \\ + \left(\begin{array}{cc} \cos \theta_5 \sin \theta_3 \beta & - \sin \theta_5 \sin \theta_4 \cos \theta_3 \beta \\ + \sin \theta_5 \sin \theta_4 \sin \theta_3 \alpha & + \cos \theta_5 \cos \theta_3 \alpha \end{array} \right) y \\ - \left(\begin{array}{cc} \cos \theta_4 \cos \theta_3 \beta & - \cos \theta_4 \sin \theta_3 \alpha \end{array} \right) z \\ + 137.75 \sin \theta_3 \beta + 160 \beta + 137.75 \cos \theta_3 \alpha + 72 \end{array} \right. \quad (\text{A.53})$$

A.1.18 Joint 5 to Manipulator Base

Substituting equations A.51, A.52 and A.53 in equations A.13, A.14 and A.15,

$$X = x \cos \theta_1 - y \sin \theta_1$$

$$X = \left\{ \begin{array}{l} \left(\begin{array}{cc} \sin \theta_5 \sin \theta_3 \alpha & + \cos \theta_5 \sin \theta_4 \cos \theta_3 \alpha \\ + \cos \theta_5 \sin \theta_4 \sin \theta_3 \beta & - \sin \theta_5 \cos \theta_3 \beta \end{array} \right) x \\ + \left(\begin{array}{cc} \cos \theta_5 \sin \theta_3 \alpha & - \sin \theta_5 \sin \theta_4 \cos \theta_3 \alpha \\ - \sin \theta_5 \sin \theta_4 \sin \theta_3 \beta & - \cos \theta_5 \cos \theta_3 \beta \end{array} \right) y \\ - \left(\begin{array}{cc} \cos \theta_4 \cos \theta_3 \alpha & + \cos \theta_4 \sin \theta_3 \beta \end{array} \right) z \\ + 137.75 \sin \theta_3 \alpha + 160 \alpha - 137.75 \cos \theta_3 \beta + 68.75 \\ - (-x \cos \theta_5 \cos \theta_4 + y \sin \theta_5 \cos \theta_4 - z \sin \theta_4) \sin \theta_1 \end{array} \right) \cos \theta_1$$

$$X = \left\{ \begin{array}{l} \left(\begin{array}{cc} \sin \theta_5 \sin \theta_3 \alpha \cos \theta_1 & + \cos \theta_5 \sin \theta_4 \cos \theta_3 \alpha \cos \theta_1 \\ + \cos \theta_5 \sin \theta_4 \sin \theta_3 \beta \cos \theta_1 & - \sin \theta_5 \cos \theta_3 \beta \cos \theta_1 \end{array} \right) x \\ + \left(\begin{array}{cc} \cos \theta_5 \sin \theta_3 \alpha \cos \theta_1 & - \sin \theta_5 \sin \theta_4 \cos \theta_3 \alpha \cos \theta_1 \\ - \sin \theta_5 \sin \theta_4 \sin \theta_3 \beta \cos \theta_1 & - \cos \theta_5 \cos \theta_3 \beta \cos \theta_1 \end{array} \right) y \\ - \left(\begin{array}{cc} \cos \theta_4 \cos \theta_3 \alpha \cos \theta_1 & + \cos \theta_4 \sin \theta_3 \beta \cos \theta_1 \end{array} \right) z \\ + 137.75 \sin \theta_3 \alpha \cos \theta_1 + 160 \alpha \cos \theta_1 - 137.75 \cos \theta_3 \beta \cos \theta_1 + 68.75 \cos \theta_1 \\ - (-x \cos \theta_5 \cos \theta_4 \sin \theta_1 + y \sin \theta_5 \cos \theta_4 \sin \theta_1 - z \sin \theta_4 \sin \theta_1) \end{array} \right)$$

$$X = \left\{ \begin{array}{l} \left(\begin{array}{ll} \sin \theta_5 \sin \theta_3 \alpha \cos \theta_1 & + \cos \theta_5 \sin \theta_4 \cos \theta_3 \alpha \cos \theta_1 \\ + \cos \theta_5 \sin \theta_4 \sin \theta_3 \beta \cos \theta_1 & - \sin \theta_5 \cos \theta_3 \beta \cos \theta_1 \\ + \cos \theta_5 \cos \theta_4 \sin \theta_1 & \end{array} \right) x \\ + \left(\begin{array}{ll} \cos \theta_5 \sin \theta_3 \alpha \cos \theta_1 & - \sin \theta_5 \sin \theta_4 \cos \theta_3 \alpha \cos \theta_1 \\ - \sin \theta_5 \sin \theta_4 \sin \theta_3 \beta \cos \theta_1 & - \cos \theta_5 \cos \theta_3 \beta \cos \theta_1 \\ - \sin \theta_5 \cos \theta_4 \sin \theta_1 & \end{array} \right) y \\ - \left(\begin{array}{ll} \cos \theta_4 \cos \theta_3 \alpha \cos \theta_1 & + \cos \theta_4 \sin \theta_3 \beta \cos \theta_1 \\ - \sin \theta_4 \sin \theta_1 & \end{array} \right) z \\ + 137.75 \sin \theta_3 \alpha \cos \theta_1 + 160 \alpha \cos \theta_1 - 137.75 \cos \theta_3 \beta \cos \theta_1 + 68.75 \cos \theta_1 \end{array} \right\} \quad (\text{A.54})$$

$$Y = x \sin \theta_1 + y \cos \theta_1$$

$$Y = \left\{ \begin{array}{l} \left(\begin{array}{ll} \sin \theta_5 \sin \theta_3 \alpha & + \cos \theta_5 \sin \theta_4 \cos \theta_3 \alpha \\ + \cos \theta_5 \sin \theta_4 \sin \theta_3 \beta & - \sin \theta_5 \cos \theta_3 \beta \end{array} \right) x \\ + \left(\begin{array}{ll} \cos \theta_5 \sin \theta_3 \alpha & - \sin \theta_5 \sin \theta_4 \cos \theta_3 \alpha \\ - \sin \theta_5 \sin \theta_4 \sin \theta_3 \beta & - \cos \theta_5 \cos \theta_3 \beta \end{array} \right) y \\ - \left(\begin{array}{ll} \cos \theta_4 \cos \theta_3 \alpha & + \cos \theta_4 \sin \theta_3 \beta \end{array} \right) z \\ + 137.75 \sin \theta_3 \alpha + 160 \alpha - 137.75 \cos \theta_3 \beta + 68.75 \\ + (-x \cos \theta_5 \cos \theta_4 + y \sin \theta_5 \cos \theta_4 - z \sin \theta_4) \cos \theta_1 \end{array} \right) \sin \theta_1$$

$$\begin{aligned}
Y = & \left\{ \begin{aligned} & \left(\begin{array}{cc} \sin \theta_5 \sin \theta_3 \alpha \sin \theta_1 & + \cos \theta_5 \sin \theta_4 \cos \theta_3 \alpha \sin \theta_1 \\ + \cos \theta_5 \sin \theta_4 \sin \theta_3 \beta \sin \theta_1 & - \sin \theta_5 \cos \theta_3 \beta \sin \theta_1 \end{array} \right) x \\ & + \left(\begin{array}{cc} \cos \theta_5 \sin \theta_3 \alpha \sin \theta_1 & - \sin \theta_5 \sin \theta_4 \cos \theta_3 \alpha \sin \theta_1 \\ - \sin \theta_5 \sin \theta_4 \sin \theta_3 \beta \sin \theta_1 & - \cos \theta_5 \cos \theta_3 \beta \sin \theta_1 \end{array} \right) y \\ & - \left(\begin{array}{cc} \cos \theta_4 \cos \theta_3 \alpha \sin \theta_1 & + \cos \theta_4 \sin \theta_3 \beta \sin \theta_1 \end{array} \right) z \\ & + 137.75 \sin \theta_3 \alpha \sin \theta_1 + 160 \alpha \sin \theta_1 - 137.75 \cos \theta_3 \beta \sin \theta_1 + 68.75 \sin \theta_1 \\ & + (-x \cos \theta_5 \cos \theta_4 \cos \theta_1 + y \sin \theta_5 \cos \theta_4 \cos \theta_1 - z \sin \theta_4 \cos \theta_1) \end{aligned} \right. \\
Y = & \left\{ \begin{aligned} & \left(\begin{array}{cc} \sin \theta_5 \sin \theta_3 \alpha \sin \theta_1 & + \cos \theta_5 \sin \theta_4 \cos \theta_3 \alpha \sin \theta_1 \\ + \cos \theta_5 \sin \theta_4 \sin \theta_3 \beta \sin \theta_1 & - \sin \theta_5 \cos \theta_3 \beta \sin \theta_1 \\ - \cos \theta_5 \cos \theta_4 \cos \theta_1 & \end{array} \right) x \\ & + \left(\begin{array}{cc} \cos \theta_5 \sin \theta_3 \alpha \sin \theta_1 & - \sin \theta_5 \sin \theta_4 \cos \theta_3 \alpha \sin \theta_1 \\ - \sin \theta_5 \sin \theta_4 \sin \theta_3 \beta \sin \theta_1 & - \cos \theta_5 \cos \theta_3 \beta \sin \theta_1 \\ + \sin \theta_5 \cos \theta_4 \cos \theta_1 & \end{array} \right) y \\ & - \left(\begin{array}{cc} \cos \theta_4 \cos \theta_3 \alpha \sin \theta_1 & + \cos \theta_4 \sin \theta_3 \beta \sin \theta_1 \\ + \sin \theta_4 \cos \theta_1 & \end{array} \right) z \\ & + 137.75 \sin \theta_3 \alpha \sin \theta_1 + 160 \alpha \sin \theta_1 - 137.75 \cos \theta_3 \beta \sin \theta_1 + 68.75 \sin \theta_1 \end{aligned} \right.
\end{aligned}
\tag{A.55}$$

$$Z = z$$

$$Z = \left\{ \begin{array}{l} \left(\begin{array}{cc} \sin \theta_5 \sin \theta_3 \beta & + \cos \theta_5 \sin \theta_4 \cos \theta_3 \beta \\ - \cos \theta_5 \sin \theta_4 \sin \theta_3 \alpha & + \sin \theta_5 \cos \theta_3 \alpha \end{array} \right) x \\ + \left(\begin{array}{cc} \cos \theta_5 \sin \theta_3 \beta & - \sin \theta_5 \sin \theta_4 \cos \theta_3 \beta \\ + \sin \theta_5 \sin \theta_4 \sin \theta_3 \alpha & + \cos \theta_5 \cos \theta_3 \alpha \end{array} \right) y \\ - \left(\begin{array}{cc} \cos \theta_4 \cos \theta_3 \beta & - \cos \theta_4 \sin \theta_3 \alpha \end{array} \right) z \\ + 137.75 \sin \theta_3 \beta + 160 \beta + 137.75 \cos \theta_3 \alpha + 72 \end{array} \right. \quad (\text{A.56})$$

REFERENCES

- [1] E. P. And, “Proceedings iros 2000 conference on intelligent robots and systems, takamatsu, japan planning and model-based control for mobile manipulators.”
- [2] R. A. Grupen, M. Huber, J. A. Coelho, Jr., and K. Souccar, “A basis for distributed control of manipulation tasks,” *IEEE Expert*, vol. 10, pp. 10–2, 1994.
- [3] N. A. M. Hootsmans, S. Dubowsky, and P. Z. Mo, “The experimental performance of a mobile manipulator control algorithm,” 1992.
- [4] R. C. Arkin, *Behavior-based robotics*. The MIT Press, 1998.
- [5] L. Petersson and H. I. Christensen, “A framework for mobile manipulation,” in *in 7th International Symposium on Robotics Systems*, 1999.
- [6] W. Feiten, B. Magnussen, J. Bauer, S. Ag, G. D. Hager, and K. Toyama, “Modeling and control for mobile manipulation in everyday environments,” in *In Int’l Symp. on Robot. Res.*, 1997.
- [7] D. C. Mackenzie and R. C. Arkin, “Behavior-based mobile manipulation for drum sampling,” in *in Proc. IEEE Intl Conf. on Robotics and Automation*, pp. 2389–2395.
- [8] C. I. Connolly and R. A. Grupen, “On the applications of harmonic functions to robotics,” *Journal of Robotic Systems*, vol. 10, pp. 931–946, 1993.
- [9] T. Yoshikawa, *Foundations of Robotics: Analysis and Control*. MIT Press, Cambridge, MA, 1990.
- [10] J. S. Albus and J. S. Albus, “Hierarchical control for robots and teleoperators,” in *Proc. of the IEEE Workshop on Intelligent Control*, 1985, pp. 39–49.

- [11] R. C. Arkin, S. Arya, W. J. Book, J. M. Cameron, W. F. Gardner, D. T. Lawton, D. C. MacKenzie, V. Ramanathan, C. Son, G. J. Vachtsevanos, and K. R. Ward, “Integrated control for mobile manipulation for intelligent materials handling,” *Mobile Robot Laboratory Publications*, 1992.
- [12] M. Xiaowei, Y. Fu, Y. Yuan, W. Wei, M. Yulin, and C. Hegao, “The path planning of mobile manipulator with genetic-fuzzy controller in flexible manufacturing cell,” in *Robotics and Automation, 1999. Proceedings. 1999 IEEE International Conference on*, vol. 1, 1999, pp. 329–334 vol.1.
- [13] R. Brooks, “A robust layered control system for a mobile robot,” *Robotics and Automation, IEEE Journal of*, vol. 2, no. 1, pp. 14–23, Mar 1986.
- [14] M. Huber, W. S. Macdonald, and R. A. Grupen, “A control basis for multi-legged walking,” in *In Proceedings of the Conference on Robotics and Automation*. IEEE, 1996, pp. 2988–2993.
- [15] M. Huber and R. Grupen, “Robust finger gaits from closed-loop controllers,” in *Intelligent Robots and Systems, 2002. IEEE/RSJ International Conference on*, vol. 2, 2002, pp. 1578–1584 vol.2.
- [16] J.-C. Latombe, *Robot Motion Planning*. Kluwer academic publishers, 1996.
- [17] S. M. L. Valle, *Planning Algorithms*. Cambridge University Press, 2006.
- [18] C. Goerzen¹, Z. Kong, and B. Mettler, “A survey of motion planning algorithms from the perspective of autonomous uav guidance,” *Journal of Intelligent and Robotic Systems*, vol. 57, no. 1-4, pp. 65–100, January 2010.
- [19] S. J. Russell and P. Norvig, *Artificial Intelligence A Modern Approach*, 2nd ed. Pearson Education, Inc., 2003.
- [20] E. Kreyszig, *Advanced Engineering Mathematics*, 8th ed. John Wiley and Sons Inc, 2002.

- [21] W. Khalil and E. Dombre, *Modeling, Identification and Control of Robots*. Hermes Penton Ltd, 2002.

BIOGRAPHICAL STATEMENT

Binu George Mathew received his Bachelors in Mechanical Engineering from Regional Engineering College, Durgapur(now, National Institute of Technology) under Burdwan University, W.Bengal, India in 1993. He started his graduate studies at the University of Texas at Arlington in the Spring of 2006. He received his Masters in Computer Science in the Fall of 2009. His research interests include Artificial Intelligence and Robotics.