



# MSRJ

UNIVERSITY OF TEXAS AT ARLINGTON  
**MCNAIR SCHOLARS RESEARCH  
JOURNAL 2016**

VOL. 20



Preparing UTA students for careers in  
research and teaching since 1990.

UNIVERSITY OF TEXAS  ARLINGTON

University of Texas at Arlington  
McNair Scholars Research Journal 2016

Volume 20

Preparing UTA Students for Careers in  
Research and Teaching since 1990



2017 University of Texas at Arlington Library MavOpenPress

This work is licensed under a Creative Commons Attribution-NonCommercial 4.0 International License. (<http://creativecommons.org/licenses/by-nc/4.0/>)

Publication Design and Formatting by Maggie Dwyer  
Cover Design by Candy McCormic

Published and made available open access by the University of Texas at Arlington Libraries, 702 Planetarium Pl, Arlington, TX 76019.

# Contents

## Introduction

Message From the Vice President for Research	vi
Notes From the Director	vii
About the McNair Scholars Program	viii
Scholarships	ix

## Papers

Comparison of LabVIEW Machine Learning Algorithms for Optimizing Grasping Patterns of a Mechanical Hand	1
---	---

**Saul Gutierrez**

Teaching Daily Drill Exercises to Visual Learning Instrumentalists	23
--	----

**Adrian Villalobos**

Effects Of Synthesis Parameters On Polydopamine Nanoparticle Size	39
---	----

**Prince Osuchukwu**

Identification of the Plateau of Cadmium Extraction from an Aquatic Medium by Invasive Macrophyte: <i>Eichhornia crassipes</i>	49
--	----

**Micalah Spenrath**

## Abstracts

The Antibacterial Activity of Organotins and Organometallics	63
--	----

**Jaclyn Bazaldua**

Essential Indexicality and Self-Consciousness	64
---	----

**Tristen Cardwell**

The Price of a Pill: Price Disparities of Common Diabetic Medications 65

**Claudia Carranza**

The Relationship between Temperament, Externalizing Behaviors, and Family Factors in Young Children 66

**Sydney Cox**

F<sub>420</sub> H<sub>2</sub>:NADP<sup>+</sup> Oxidoreductase Hydride Transfer Rates: Kinetic Analysis of Thr99 Mutant 67

**Katie Kang**

Content Analysis of Foreign Policy Speeches: Critical Issues Based on North Korea 68

**Minwoo Kim**

Characterization of Early Damage in Airframe Structures Using Embedded Magnetostrictive Particles 69

**Nicolas E. Long**

Attitudes and Uses of the Spanish Language in the Dallas-Fort Worth Metroplex 70

**Claudia Martinez**

Silane Dimerization Enabled by Ruthenium Catalysts 71

**Jessica McCammon**

Will the Real Amadeus Please Stand Up: A Historic Reappraisal of Peter Shaffer's *Amadeus* and the *Memoirs of Lorenzo Da Ponte* 72

**Kayleigh Miranda**

# Message From the Vice President for Research

**Duane Dimos, Ph.D.**

As education is essential to providing a foundation for the future of society, research is vital to the discovery, invention, and innovation driving our world. Through The University of Texas at Arlington strategic plan, 'Bold Solutions, Global Impact', UT Arlington is committed to being The Model 21st Century Urban Research University. This vision reflects the importance of university research in meeting the needs of our students as well as those of the state, nation, and world. The vision also highlights the importance of taking on research that is appropriate to the needs of the community, which for us is the rapidly growing Dallas-Fort Worth-Arlington metroplex.

The McNair Scholars Program plays an important role in preparing the researchers who will provide solutions to the world's challenges. For promising students from low-income/first-generation or under-represented backgrounds, it is also a means to realize their dreams and ambitions. The McNair Scholars Program has a long history of assisting promising students from low-income, first-generation, or under-represented backgrounds with the opportunity to excel in their academic pursuits.

Pursuing a PhD degree takes a lot of hard work, long hours of study and training, and dedication and persistence. But the efforts that prepare students to earn a doctoral degree also prepare them for a lifetime of discoveries and contributions that will shape our future. These students will be the innovators and entrepreneurs who develop the technologies that transform the results of those discoveries into improvements in health, education, and economic growth.

The University of Texas at Arlington is proud to be a supporter of the McNair Scholars Program. Those of us who have been privileged to work with McNair Scholars and to witness the transformation from students to scholars are impressed with their sophistication and, as mentors, take great pride in their accomplishments. My special thanks to the faculty who have mentored them.

Congratulations Scholars on your acceptance into the program. You have completed impressive work. It is work that portends an exciting future for you and for the promise your future contributions will make.



# Notes From the Director

## Joan Reinhardt, Ph.D.

Each year the staff of the University of Texas at Arlington's McNair Scholars Program has the wonderful opportunity to work with a group of talented and creative undergraduates for whom the baccalaureate degree will be the stepping-stone to future advanced study. Consequently, McNair program objectives focus on diverse activities and experiences that will educate participants about both research and graduate school. It is hoped that this will better prepare participants for successful pursuit of the PhD and ideally a career in research and teaching.

An essential element of being a McNair Scholar consists of undertaking a rigorous research project, guided by a UTA faculty mentor, between the junior and senior years. In the spring semester before the research internship, participating Scholars design a project that they carry out over the summer. In both the planning and execution states, the student researchers benefit from the guidance of their mentors.

In early August, McNair research interns share their findings with the campus community. Each year the results of such hard work are both fascinating and enlightening! For some Scholars, this research may become the basis of a future master's thesis and/or doctoral dissertation.

In the 2016 edition of *The University of Texas at Arlington McNair Scholars Research Journal*, you will discover and I hope enjoy the varied work of fourteen Scholars, most of whom will by next fall be on the path to a graduate degree.

In conclusion, I would like to thank the UTA leadership—President Vistasp Karbhari, Interim Provost Ronald Elsenbaumer, Vice President for Research and Dean of the Graduate School Duane Dimos and Dean of the UTA Library Rebecca Bichel, in addition to other members of the campus community (especially the faculty on the McNair Selection Committee) for their commitment not only to this program but also for their support of research excellence at all levels of this institution.



# About the McNair Scholars Program

The McNair Scholars Program (officially known as the Ronald E. McNair Post-Baccalaureate Achievement Program) came to the campus of The University of Texas at Arlington in 1990. Created by the U.S. Congress in 1988, it is named after Dr. Ronald E. McNair, who perished with his fellow astronauts on the space shuttle *Challenger* two years earlier. The McNair program endeavors to assist talented undergraduates – either first-generation and low-income or underrepresented students – to prepare for graduate study leading to the Ph.D. and the professoriate.

Since its beginning at UT Arlington, the McNair program has encouraged and assisted over 300 students in various majors. Currently, it works with 34 students each academic year, providing seminars and classes on topics related to graduate school and the GRE, an May institute to heighten scholars' understanding of the culture of research, and a summer research internship. The program also provides guidance with the graduate school application process and travel funds to participate in conferences and visit prospective graduate programs. UT Arlington McNair graduates have subsequently earned masters and doctorates not only from their alma mater, but also from an impressive array of universities including Harvard, Indiana, Rice, and Southern Methodist, among others.

The McNair Scholars Program enjoys strong support from the UT Arlington administration and greatly benefits from the expertise and enthusiasm of both faculty and staff. Faculty members who serve on the McNair Selection Committee and those who act as mentors to McNair interns deserve special recognition. Members of the 2015-2016 Selection Committee include the following UTA faculty and staff: Dr. Karishma Chatterjee (Communication), Dr. Laureano Hoyos (Civil Engineering), Dr. Raymond (Joe) Jackson (Office of Graduate Studies), Dr. Zdzislaw Musielak (Physics), and Dr. Debra Woody (Social Work).



Dr. Ronald E. McNair  
Scientist & Astronaut,  
1950-1986

## McNair Staff Members



Joan Reinhardt, Ph.D.  
Director



Cheri Counts,  
Admin Assistant



Natalie Stephens, M.Ed.  
Learning Specialist II



# Scholarships

## Kathryn A. Head Scholarship Winners

In summer of 2016 the Kathryn A. Head Scholarship for McNair Scholars was awarded to Kayleigh Miranda, a music major mentored by Dr. Graham Hunt, Professor of Music and Music Theory, and John Etta Rasberry, a kinesiology major mentored by Dr. Priscila Caçola, Assistant Professor of Kinesiology. Selection criteria included the Scholar's application essay, GPA, letters of recommendation, and commitment to pursuing research and the Ph.D.

The scholarship honors the long and exemplary career of Kathryn A. Head, former director of the McNair Scholars Program and SOAR Learning Services. The scholarship committee includes Natalie Stephens, McNair Learning Specialist II; Jennifer Luken-Sutton, Student Support Services Director; Dr. Jared Kenworthy, Associate Professor of Psychology and former McNair mentor; and Laura Wolf, Assistant Director and Coordinator of University Studies. We thank our committee members for their commitment to selecting the best candidates for this honor, and we congratulate Kayleigh and John Etta on receiving it.



John Etta Rasberry (left), and Kayleigh Miranda.

## Friends of the UTA Library Scholarship Winners

McNair Scholars Saul Gutierrez (Computer Science & Engineering) and Adrian Villalobos (Music Education) received the 2016 Friends of the UT Arlington Library McNair Scholarship. The scholarship recipients are determined annually by the excellence of the Scholars' research presentations and papers, as assessed by members of the Friends McNair Scholarship Committee: Julie Alexander, Dr. LaVerne Knezek, and

C.D. Walter. This year the McNair Research Journal is on-line, with the technical assistance and financial support of the UTA Library. The on-line version of the journal includes the four top-ranked papers, those by the two scholarship winners as well as Prince Osuchukwu (Biomedical Engineering) and Micalah Spenrath (Earth and Environmental Science), as selected by the committee. Nicolas Long (Mechanical Engineering) authored a paper chosen by the committee, but it could not be published as his research was conducted at the Army Research Laboratory in Aberdeen, Maryland, and contains sensitive information. All other 2016 McNair research interns share their results by having their abstracts published in the journal.

The McNair Scholars Program congratulates its 2016 scholarship winners and thanks the Friends of the UTA Library for their continued support. Special thanks to Rebecca Bichel, Dean of the UTA Library, and the current officers of the Friends of the UTA Library: Julie Alexander (president), Lynne Prater (first vice president), Betty Clark (second vice president), Carol Lehman (secretary), Mary Castle (treasurer), and Melissa Deur (parliamentarian).



Adrian Villalobos, Joan Reinhardt, and Saul Gutierrez at the Friends of the Library meeting, November 4, 2016.

# Comparison of LabVIEW Machine Learning Algorithms for Optimizing Grasping Patterns of a Mechanical Hand

**Saul Gutierrez**

Computer Science & Engineering

Mentor: Dr. Panos S. Shiakolas, Director of  
MARS Lab

Department of Mechanical and Aerospace Engineering



## Abstract

In the development of prosthetic hands researchers need to understand, implement, and apply Machine Learning (ML). LabVIEW provides a ML Toolkit that contains Supervised ML algorithms: Artificial Neural Networks (ANN), K-Nearest Neighbor (KNN), Learning Vector Quantization (LVQ), and Support Vector Machines (SVMs). This study gathers missing transition-using information with flexor and force sensors and looks to find which of the algorithms, using this data, most accurately classifies whether or not an object is spherical or cylindrical. The algorithms will be empirically analyzed for their implementation simplicity and their effectiveness for classification. Data is gathered with a haptic glove using various grasp standardizations to evaluate/investigate which algorithm would provide the most optimal classification accuracy. Using a method of gathering data that most accurately represents the limitations of the prosthetic hand, SVMs were chosen as the best ML algorithm for this problem with an average accuracy classification ability of 97%. With the aim of optimally estimating the diameter of the object, Artificial Neural Networks were employed and were able to estimate the diameter of 95.4% of the objects presented with less than 15.42% error in diameter with a mean of 5.88 and a standard deviation of 4.77.

## Introduction

Many people have lost mobility in their limbs, particularly in their hands, due to various causes. Lacking an arm and hand restricts mobility and diminishes the performance of some daily tasks (mainly grasping). As a result, there is an engineering interest to give back mobility and functionality to those without an arm through research into improved prosthetics. In the development of prosthetics, it is important to mimic the human hand as much as possible, for instance, when it comes to grasping objects. In this research, various ML algorithms in the software LabVIEW by National Instruments were investigated to evaluate which was the most user friendly and effective.

Many factors affect the simple human action of grasping. These factors will be identified and studied, particularly concerning the geometry of objects and how it affects the complexity of the problem and the corresponding complexity of the prosthetic. Information gathered from Flexor and Force sensors attached to a Master glove, were used to train the ML algorithms in classification of objects. The objects investigated were spheres and cylinders. Moreover, once the object was classified using one of the ML algorithms, the diameter of the object was found by employing a data specialized ANN.

An approach to finding a solution is through human-robot interactions (HRI), where there has been a recent paradigm shift in ML from a statistical approach to more supervised learning approach, such as programming by demonstration (PbD) or learning by demonstration (LbD). This supervised learning approach started 30 years ago but gained importance from 2000 to 2010 [1]. PbD reduces the search for the solution by starting close to the “optimal” solution or by deleting from the search space a bad solution [1]. This research is driven to create an interface where non-technical persons/users could easily interact and program robots to do specialized tasks without writing low level code. This application of training machines or robots with ML algorithms could be applied in hospitals, construction sites, and manufacturing plants among other areas. There are 5 major paradigm shifts in ML algorithms: Neural Networks (NN), Instance-Based, Generic, Rule Induction, and Analytical [2]. Some are based on observations and tradition rather than scientific reasoning.

## Machine Learning Overview

ML has developed over the years in terms of complexity and application. Several applications now exist, for example, for detecting oil spills in satellite radar images. Previously, humans were trained to differentiate oil slicks, which are less reflective than the surface of the ocean [3], from algae, rain, or other similar images that also appeared on the radar. One such system, created by Anne H. Solberg and Rune Solberg, used a statistical classifier in the form of a decision tree [3]. Using prior computed probability of the region of an oil spill, a Gaussian classifier taught by training data was used to correctly classify 94% of oil spills and 99% of non-oil spills.

Another example of ML application has been developed in response to the presentation that modified nucleosides (MN) could be “potential tumor markers for breast

cancer” [4]. MN are present in the urine but exhibit different patterns if breast cancer is present. Many publications have described attempts to identify these patterns using computer software and found that ANNs have been the most effective in making accurate predictions. The most popular type of ANN is backpropagation, and a preliminary study has found that it has been outperforming other ML algorithms such as KNN, rule induction, and discriminant analysis in regards to classification [4].

Neuroscience research has inspired the development of the ANN ML algorithm. This algorithm is composed of multiple networks of units connected by links that spread the information. The links themselves have weights that control the amount of activation of the unit, which usually “improves classification or prediction accuracy” [3]. The most common structure of an ANN involves 3 layers: input, hidden, output (see Figure 1). The information of the ANN flows from the bottom upward, in some cases using a feedback path like backpropagation to adjust the performance until the desired weights are achieved [5]. The nodes in the input layer are passive and do not modify the data, however, the hidden and output layers are active and do modify the submitted information. The weights themselves are determined by the algorithm. The weighted input is then summed up and sent to a smooth sigmoid function that limits the value to the range specified by the user. However, in the study regarding the detection of MN patterns, the researchers wanted to evaluate the performance of LVQ against ANNs and SVMs [4].

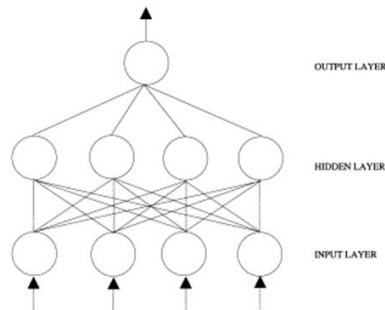

Figure 1: A typical feedforward Neural Network [6].

SVMs are algorithms that find linear models to separate classes of patterns [4]. They are based on a principle from computational learning theory called structural risk minimization (SRM) [7]. Having a data set with  $n$  number of examples, there would be  $2^n$  ways to label the examples in a binary fashion, and the set of planes able to separate these examples resides in a space called  $H$ , known as a Vapnik-Chervonekis (VC) dimension [8]. Using the SRM, the goal was to find the optimal hypothesis  $h$  that has the lowest true error,  $h$  being a member of  $H$  [7]. The true error is the probability that  $h$  will make an error in classifying an unknown sample. SVMs find  $h$  and use support vectors from the data, as shown in Figure 2, to separate and classify the data. The algorithm uses a small amount of vectors for support, which reduces the risk of overfitting; with the variables that are modifiable in LabVIEW, the algorithm can allow for flexibility in clas-

sification for over-complex relationships by modifying the parameter and marginal plane. A further detailed explanation of SVM and ANN can be found in [4].

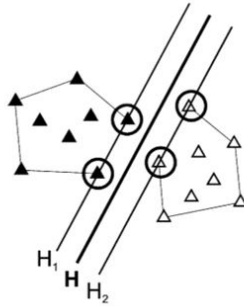

Figure 2: Objects are separated by hyperplanes, and vectors within the boundary of  $H_1$  and  $H_2$  are used as support vectors [4].

The Instance-Based learning approach presents the information by cases and uses lenient matching methods to fetch and apply those cases when given a new situation. The robustness of the method depends on the indexing scheme and the metric it uses to find the relevant cases. One example of such an approach would be the KNN algorithm, which uses a variety of methods; methods are based on (a) whichever vector is the closest class to the object vector that is being compared; or (b) a majority vote regarding the closest class vector, which is more effective in getting rid of noise in the data than the first method; and/or (c) the distance of each class center vector, which is used when there is little pattern within the data [9]. Furthermore, based on the distances of the examples, it classifies them as shown in Figure 3.

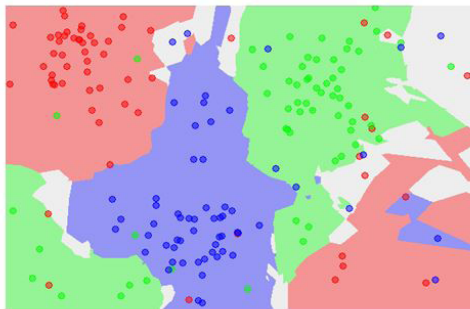

Figure 3: The location of the sample in N-dimensional space affects how the object will be classified [10]

A generic algorithm represents information using binary or Boolean features [2]. It generally resembles a list of rules that the computer follows to decide conflicts and is customarily an all-or-none matching process. The process may be performed in sequence, creating a multi-step behavior within a production-system architecture. It uses operators such as “crossover and mutations to generate new candidate rules from parents that have high strength,” which then translates into some indication of performance on training cases [2].

Similarly, the Rule Induction paradigm involves condition-action rules, decision trees, and like structures [2]. It greedily searches through the structure or rules until it finds a match with the instance and is also an all-or-none process. Usually, the algorithm partitions the data in disjoint sets and encapsulates them into a series of logical conditions.

The last paradigm is Analytical Learning, which denotes the rules in a logical form. This method performs by enacting a search process to solve multi-step problems, depending on background knowledge to construct proofs into more complex rules that can solve related problems with less searching using “search control rules” and “macro-operators” [2].

## Machine Training and Learning

Various methods are used to train a machine/robot, such as manually inputting training data and vision training. One of the methods used to train the artificial hand to achieve an appropriate grasping pattern is to have the user wear a sensor embedded glove. Grasping is an elementary skill for humans and requires a direct mapping device to differentiate between the actuator action and the corresponding sensor input [11].

There are 3 types of learning processes in robotics: passive, active, and implicit [11]. Using the Master Glove in the MARS lab and following an active learning process, the user can explore the objects and the user grasping pattern will be recorded. The passive process is used if the robot is manipulated by an external master control such as a master-slave system or a graphical interface. Implicit learning is accomplished by the user manually providing the instructions by choosing a set of commands, some of which could be graphical [11].

Using PbD or LbD methods, computers are given learning information in order to create abstract maps, protocols, or trajectories to recreate the action in different environments. The basic cycle of PbD is first to record the task demonstrated, then to generalize it into abstract knowledge, and finally to map it to specific tasks for the targets [12]. Many factors fall into creating accurate scenarios, such as the difference in environment where the machine was first taught and where the action will take place, as well as the object factors, such as geometry, weight, and surface finish. Therefore, the goal is to mine as much information as possible from a human demonstration and be able to create an abstract representation that could make it possible to be used for multiple robots [12].

## Experimental Setup and Instrumentation

### LabVIEW Platform

LabVIEW is programmed using a block-style programming format to simplify the programming aspect as shown in Figure 4 and to develop graphical user interfaces (GUIs) as shown in Figure 5. LabVIEW is an ideal platform for interfacing with sensors and actuators because of its built-in utilities. Previously, Shah developed a program that can capture the motion of the fingers of the Master Glove [13]. The resistances from the motion of the Master Glove is observed by the user through LabVIEW by National Instruments. The Machine Learning Toolkit in LabVIEW provides various supervised learning algorithms, and KNN, SVM, and ANN were programmed and evaluated in LabVIEW.

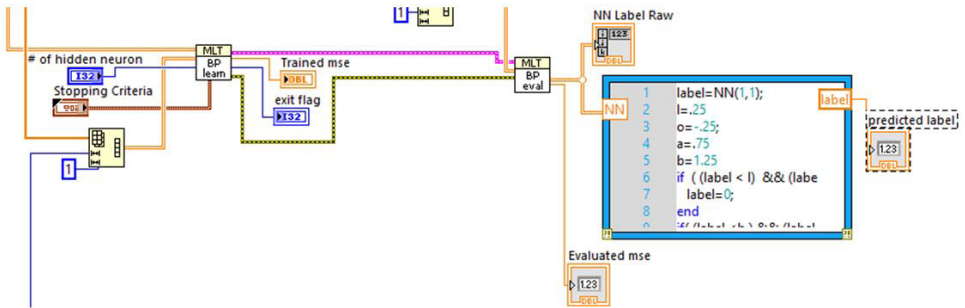

Figure 4: A snippet of code from one of the implementations of the ML Toolkit used in this work.

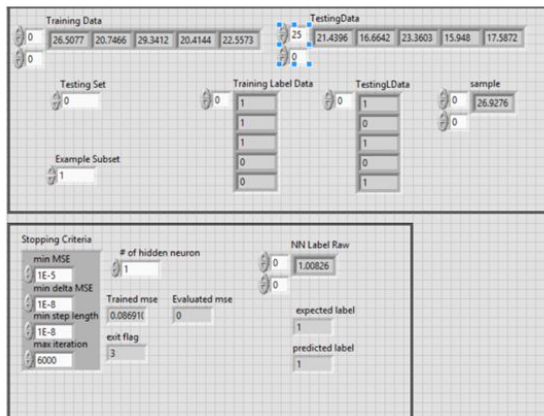

Figure 5: A GUI from one of the implementations of the ML Toolkit used in this work.



## Master Glove

The glove is used as the PbD master for the prosthetic hand in an effort to teach it to mimic the motions of the human hand to grasp various objects (see Figure 6). The glove has embedded flexor and force sensors, which change in resistance when bent or pressed. A resistance change results in a change in voltage, which is easily acquired, processed, and displayed in LabVIEW. The user wears the glove to grasp various objects and the motion of each finger as a function of the resistance change in the flex sensor is captured/recorded in LabVIEW. The capture data is then processed and analyzed and used to train the ML algorithm for classification and diameter identification.



Figure 6: The sensor-embedded Master Glove that the user wears while grasping objects collects data for machine training.

## Testing Objects

The potential variety of objects used in the experiment is reduced by the capabilities and design of the artificial hand. For example, an object may be too heavy for the hand to grasp because of inadequate slip or grip strength, or an object may be too wide for the hand to correctly grasp it. Irregular geometries are important to consider, since the specialized geometries of an object restricts the ability of the hand to grasp objects with an intended functional grasping pattern; the lack of grip caused by the inability to grasp in a certain pattern would result in dropping the object.

In this study, a variety of different sized cylinders and spheres were used. Spheres and cylinders were chosen for their simple geometries. The length and width were recorded in millimeters and the mass was recorded in grams. Using the Master Glove, the resistance of the flex sensors, measured in kilo-ohms, and the analog voltage of the force sensors, measured in volts, were recorded for each object. The values of the resistances from the flex sensors were used since they indicate how much the fingers bend when an object is grasped.

## Methodology

The ML algorithm is best trained when there is a large number of training data sets or patterns. The training data set or patterns was generated using a variety of common household objects (see Figure 7).



Figure 7: Objects used in the experiment to grasp.

It was also important to consider the type of grasp pattern that the user would perform. The motion that would be captured by the Master Glove would eventually be reproduced by the artificial hand, so the user would have to grasp in a way that could be emulated by the artificial hand. Each object was grasped, and the sensor information was recorded five times for accuracy and repeatability. To achieve the desired and realistic results needed in the data, we used 4 different approaches to acquire it.

### Grasping Methods

The natural method, Method 1, was with only a thumb restraint inside the glove, which helped restrict its movement to only the opposition of the thumb as shown in Figure 8. The limitation of the motion of the artificial thumb is described in more detail in the Appendix. Also, all the objects were brought to the hand because the current prosthetic hand consists only of a palm and five fingers without actuated palm bending or rotation.



Figure 8: The subject was told to grab the object without any instructions.

The placement method, Method 2, shown in Figure 9, considered the controlled pressure points with the fingers placed at specific locations on the object.



Figure 9: The subject was asked to place the fingers in the center of the objects.

The wrap method, Method 3, shown in Figure 10, involved controlled object placement on the palm with natural collapse of fingers.



Figure 10: The object was placed in the palm of the subject, who was told to grasp the object naturally.

The final method, Method 4, had the subject make a conscious effort to keep his finger from abducting the fingers with spacers made out of cardboard in an effort to mimic the characteristic of the robotic hand as much as possible. The motion of abduction and adduction of the fingers and artificial hand are described in the Appendix. Additionally, the object was placed in the base of the fingers and the fingers were allowed to collapse naturally with the previous restrictions in place. See Figure 11.



Figure 11: The spacers placed between the four fingers help to more accurately mimic the prosthetic hand.

In order to determine which method worked best to distinguish the difference of resistances, a statistical t-test was performed to determine how similar the grasp pattern was between a sphere and a cylinder. Visual analysis was used to determine which grasping method was more plausible, since the grasp should be comfortably reproducible by the user (and eventually the artificial hand).

The second step was to identify the appropriate parameters required to effectively evaluate the efficiency of the ML algorithm. Among some of the parameters of interest identified were computation speed, system delay, and ability to easily incorporate additional tools and interface with sensors and actuators. The simplicity of the algorithm is necessary, since the end user may not have the educational and/or software background to make extensive modifications in the algorithm. The more complex the algorithm, the more time it will require to perform the demanding computations, which in turn would cause a delay in the system and a lapse in communication between the user and the robot. It is important that the algorithm does not cause a significant delay in the operation of the system.

In order to test the algorithms in practice, it will be important to implement and test each algorithm with a 3-cross validation process. This will determine whether the algorithm has classified the object correctly. The percent classification accuracy will also be calculated. The algorithm that performs best in terms of computation speed and system delay, and has the highest classification accuracy determined by the 3-cross validation process, will be chosen as the algorithm to be implemented in the HRI process.

The final step will be using ANNs to find the geometric properties (length and diameter) of the spheres and cylinders. After an algorithm is chosen, two ANNs will be trained using the same data but each will be trained exclusively with data concerning either spheres or cylinders to maximize estimation capability. Depending on the output label

of the object, the appropriate ML algorithm will be employed to provide the diameter estimation. The estimation will be compared with the experimental diameter of the object and the average percent difference will be calculated to evaluate the accuracy of the ANN.

## Results and Discussion

### Process of Data Collection

The four grasping methods were carefully developed through a process of exploration to find the optimal representation of realistic data for the hand to use. The mass of each object and the analog voltage of the force sensor were recorded; nevertheless, this data was not used because it was later determined not to be relevant in aiding the classification process of the geometry of objects. Using the acquired flex sensor data, the sensitivity of the flex sensors was calculated to be approximately 6.42mm/Kohm and was used to assess if there were objects that were not measurably distinct in order to remove them, allowing for more distinct training sets.

The first method does not provide realistic motions that can be reproduced by the robotic hand. Even though this style best distinguished the contour of the shapes, this method of gathering data was unrealistic since the robotic hand cannot move exactly like a human hand. There were other movements at work while the subject was grasping the object that the hand cannot replicate because of hardware limitations, which affected the collected data.

Method 2 is more repeatable and is believed to accentuate the differences between the sphere and cylinder, but the artificial hand cannot control and pick where its fingers will go and neither can it move its fingers from side to side. The similarity was low for this style as well and the values were unrealistic. Considering the primitive grasp capability of the artificial hand, Method 3 was used to evaluate or test if mimicking the basic grasp would still provide low similarity but achieve more realistic results.

By analyzing and watching the hand more closely, it seemed it would be difficult to grasp the object if it were placed at the palm of the glove, which was done during the data collection. On the other hand, the user wearing the glove commented that this style was the most natural and comfortable. Moreover, seeing how the artificial hand did not have the required adhesive palm, this method gave the impression that if one were to place the object at the center of the palm of the artificial hand, it would not be able to grasp it since it would slip. The abduction of the fingers still presented a problem, which led to the development of Method 4.

Since it is difficult to constrain the hand to conform to the characteristics of the artificial hand without impeding data collection, a temporary solution was to develop simple spacers to be placed between the fingers, excluding the thumb. It would not have made a significant difference if we added restraints to impair abduction rather than confiding in the subject to maintain a conscious effort to keep their fingers controlled. The last method, Method 4, is repeatable and realistic since we have recreated the characteristics of the robotic hand the best we could on the glove. The level of similarity was satisfactory when

the objects were large (approximately 4-inch diameter) and small (approximately 2-inch diameter), but when the objects were medium sized (approximately 3-inch diameter) the similarity improved.

Similarity is defined in the t-test in Table 1 as how close the mean of the set of resistances for a sphere of a particular diameter size is to the mean of its cylindrical counterpart. None of the methods had perfect dissimilarity. The average is important to consider but most of the data is skewed by a finger motion being very similar. Since there may be a finger that could offset the average for some of the methods, being able to evaluate how often the null hypothesis is rejected will provide a clearer perspective in deciding which method best indicates the difference in the grasping patterns between spheres and cylinders. As presented in Table 2, with the label of A as accepting the null hypothesis and R as rejecting the null hypothesis a clearer representation of the data is observed.

Table 1 t-Test of various size objects

t-Test: Paired Sample for Mean- $\alpha=0.05$						
Probability Percentages for Methods of Data Collection - Large Objects						
Method	Pinky [%]	Ring [%]	Middle [%]	Index [%]	Thumb [%]	Avg [%]
1	0.056	0.356	0.079	0	0.001	0.098
2	0.003	0	0.001	0	0	0.001
3	0.051	0	0.004	0	0	0.011
4	0.003	0.023	0.619	0.007	0	0.130
t-Test: Paired Sample for Mean- $\alpha=0.05$						
Probability Percentage for Methods of Data Collection - Medium Objects						
Method	Pinky [%]	Ring [%]	Middle [%]	Index [%]	Thumb [%]	Avg [%]
1	0.011	0.025	0.017	0	0	0.011
2	0.001	0.253	0.004	0.003	0	0.052
3	0.039	0.174	0.001	0	0	0.043
4	0.498	0.574	0.267	0.004	0	0.269
t-Test: Paired Sample for Mean- $\alpha=0.05$						
Probability Percentage for Methods of Data Collection - Small Objects						
Method	Pinky [%]	Ring [%]	Middle [%]	Index [%]	Thumb [%]	Avg [%]
1	0.012	0.001	0.038	0	0.001	0.010
2	0.006	0	0.011	0.602	0.004	0.125
3	0.104	0.758	0.121	0.006	0.002	0.198
4	0	0.006	0.001	0	0	0.001

Table 2 Representation of Table 1 in terms of accepting the null hypothesis and rejecting the null hypothesis.

t-Test: Paired Sample for Mean- $\alpha$ =.05						
Probability Percentage for Methods of Data Collection - Large Objects						
Method	Pinky	Ring	Middle	Index	Thumb	Avg Rejection %
1	A	A	A	R	R	40
2	R	R	R	R	R	100
3	A	R	R	R	R	80
4	R	R	A	R	R	80
t-Test: Paired Sample for Mean- $\alpha$ =.05						
Probability Percentage for Methods of Data Collection - Medium Objects						
Method	Pinky	Ring	Middle	Index	Thumb	Avg Rejection %
1	R	R	R	R	R	100
2	R	A	R	R	R	80
3	R	A	R	R	R	80
4	A	A	A	R	R	40
t-Test: Paired Sample for Mean- $\alpha$ =.05						
Probability Percentage for Methods of Data Collection - Small Objects						
Method	Pinky	Ring	Middle	Index	Thumb	Avg Rejection %
1	R	R	R	R	R	100
2	R	R	R	A	R	80
3	A	A	A	R	R	40
4	R	R	R	R	R	100

The average rejection rate for the fingers from Methods 1 to 4 in Table 2 is as follows: 80%, 87%, 66%, and 73%. This result indicates that the second method is shown to be the best method to accentuate the shape features of the object. However, keeping in mind that this method would not only have to generate data to train the ML algorithm but also have to be reproduced by the artificial hand. Based on these factors the decision was made to use Method 4.

After the grasping method was chosen, the ML algorithm for classification was selected. It is important to note that the computer used had an Intel Core i7 with 2.4 clock speed with 12GB of RAM. Computation speed and system delay were negligible among all the algorithms and did not significantly affect the runtime of the program. However, ANN and SVM were the most computationally intensive during training and testing, since there was noticeable lag while working with them. The ANN may pose a problem when trying to figure out the optimal setting for the user's intended purpose since it is trained via neurons and iterations. A brute force method was used to determine the optimal setting with this project. A program was designed and implemented to improve the performance of the ANN by increasing the number of iterations and the number of hidden neurons using a nested loop and control statement with 2 conditions. Using control statements, the program was executed with the condition that every time the number of neurons reached 50, the number of iterations would increase by 1. This process was con-

tinued until the training mean square error (MSE) was below the value of 1, which was the second conditional control statement before exiting the nested loop.

Eventually, the MSE plateaued at each neuron as iterations increased, and there was no significant change in the MSE. Nevertheless the MSE exhibited a polynomial trend. It was decided to limit the number of neurons from 1 to 5 with the rationale that people have 5 fingers and because, in general, lowering the number of neurons may help with generalization [6]. After analyzing the data shown in Figure 12, it was decided that having one neuron with 6000 iterations was one of the best configurations for training. Note that the basic trend is that the greater the number of iterations and number of neurons, the lower the MSE value. Although the ANN provided in the toolkit used only one hidden layer, a single layer is sufficient to approximate any continuous function [14].

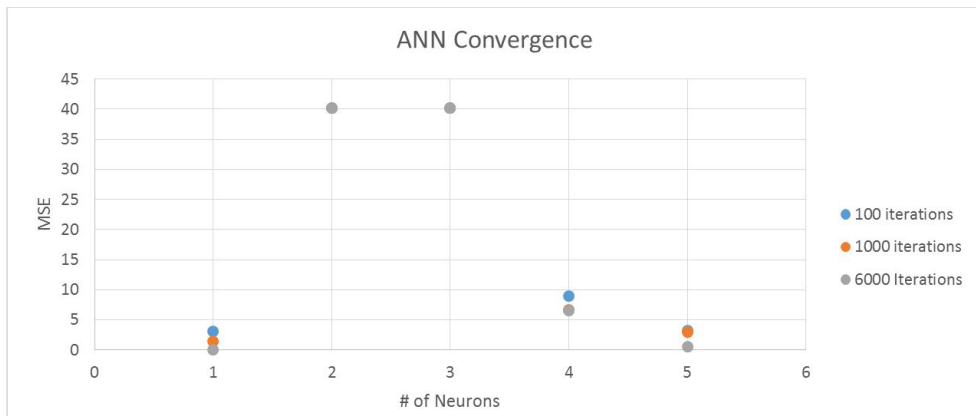

Figure 12 Displays the MSE with respect to the number of iterations and neurons.

SVM is inherently designed however to be as efficient as possible by calculating the vectors most relevant to classification, so it should handle larger data sets well. SVM also had the following parameters to work with: kernel type, parameter, and soft margin [15]. The possible kernel types were polynomial, linear, and Gaussian. A polynomial was used because multiple features needed to be included to determine the geometry. The parameters were kept at default values because the accuracy of its classification was not affected whether the parameter was set to 4 or under. The value of the soft margin did need modification as a result from the parameter. Furthermore, the SVM algorithm chooses the largest possible margin for each support vector [14].

## Algorithm Comparison

All algorithms were able to reproduce their results during testing with ANN and SVM being the best at classifying. Noting that the resistances correspond to the distance the fingers must bend to grasp the object, it seems likely that if it were possible to get very precise and repeatable results from data collection, KNN would be the best algorithm because of its design. For instance, because of the simple geometry of the objects used in testing, the only significant change is the diameter. The curvature of the spheres and



the relatively flat sides of the cylinders would help separate the two sets of data; if the data set increases by changing the diameter, then it would follow the same pattern with decreased length in vectors as the size of the object increases. KNN may also be the top choice because of its low computation time for the amount of data sets included in the testing set and simplicity to program. As the number of data sets increases the computation time will increase because of the multiple nested loops in the KNN algorithm. On the other hand, KNN does not predict as well as SVM and ANN because of the small number of available objects for training.

Training and testing sets were created to perform a 3-cross validation to verify the classification ability of the algorithms, as shown in Table 3. The sets were created using a similar leave-in-leave-out process until 3 sets were cumulatively obtained.

Table 3 Total Number of Spheres and Cylinders in the Training and Testing Sets

Training Sets			
Training Set #	# of Spheres	# of Cylinders	Total
1	21	18	39
2	28	24	52
3	17	16	33
Testing Sets			
Testing Set #	# of Spheres	# of Cylinders	Total
1	14	12	26
2	7	6	13
3	17	15	32

KNN had two classification methods: closest and majority vote. The closest had the most success because of the way testing was set up as shown in Table 4. One of the faults of training was its lack of unique objects. The training and testing consisted of repeated trials of grasping the same object so that when the data was split, so was that characteristic. With majority vote, increasing the number of votes can help or reduce its classification ability as shown in Tables 5, 6, and 7. This problem can be more apparent with more unique objects used in the testing set.

Table 4 Results from the Testing Set for KNN

K-Nearest Neighbor-Closest			
Test Set #	# of misidentified spheres	# of misidentified spheres	% Accuracy
1	0	0	100
2	0	1	92.3
3	1	2	90.6

Table 5 Results from the Testing Set for KNN: Major Vote with 3 votes

K-Nearest Neighbor-Majority Vote (3)			
Test Set #	# of misidentified Sphere	# of misidentified Cylinder	% Accuracy
1	0	1	96.2
2	0	1	92.3
3	1	4	84.4

Table 6 Results from the Testing Set for KNN: Major Vote with 5 votes

K-Nearest Neighbor-Majority Vote (5)			
Test Set #	# of misidentified spheres	# of misidentified spheres	% Accuracy
1	0	1	96.2
2	0	0	100
3	1	3	87.5

Table 7 Results from the Testing Set for KNN: Major Vote with 7 votes

K-Nearest Neighbor-Majority Vote (7)			
Test Set #	# of misidentified spheres	# of misidentified spheres	% Accuracy
1	0	1	96.2
2	0	0	100
3	1	4	84.4

As shown in Table 8 and Table 9, using ANN, test sets #1 and #2 were 100% accurate. During testing, it seemed that both algorithms were misclassifying the same objects, which may indicate the presence of unavoidable poor data within the sets.

Table 8 Results from the Testing Set for ANN

Artificial Neural Networks			
Test Set #	# of misidentified spheres	# of misidentified cylinders	% Accuracy
1	0	0	100
2	0	0	100
3	1	2	91

Table 9 Results from the Testing Set for SVM

Support Vector Machines			
Test Set #	# of misidentified spheres	# of misidentified cylinders	% Accuracy
1	0	0	100
2	0	0	100
3	1	2	91

Due to ANN and SVM relying on generality, they still did not classify all the objects correctly. Both algorithms tied and most likely misclassified the same objects. However, ANN uses a summation technique to classify objects so its output is not necessarily a 1 or 0, but rather a number close to 1 or 0. A range scheme was used in an effort to correct this, though it is difficult to justify defining a range. If the NN output was between -0.25 and 0.25, then the value was converted to 0; if the value was between 0.75 and 1.25 then it was converted to 1. Such a problem can be managed to an extent, but if there were an object that the ANN could not classify and the output resulted in 0.5, then the program would not be able to continue running as it would not be able to classify an object without a bias. The ANN used in LabVIEW is better suited for more variable values, not discrete outputs. SVM, on the other hand, can produce discrete values, which solves this issue. This is the determining factor in deciding which algorithm to use. As a result, SVM was chosen as the preferred ML algorithm for classification.

After an object is classified as sphere or cylinder, ANN will be employed to determine the diameter of the object. The same ANN topology of 1 neuron and 6000 iterations was defined since the objects were all from the same data set.

The percent difference between the predicted and original diameter for each object is presented in Table 10. The ANN performed with an average of 5.88% error. With a standard deviation of 4.77 mm, 95.4% of the data had less than 10% error, which is expected because of the accuracy of the flex sensors and the amount of data that the NN was trained.

Table 10 Percent Difference in Predicted Diameter Using ANN.

Object #	%	Object #	%	Object #	%	Object #	%	Object #	%
1	8.74	16	2.16	31	0.11	46	2.57	61	8.35
2	7.92	17	5.6	32	2.51	47	6.5	62	1.88
3	5	18	0.74	33	0.11	48	5.81	63	5.88
4	3.55	19	1.71	34	12.98	49	7.48	64	4.55
5	3.42	20	5	35	8.95	50	1.29	65	6.86
6	4.18	21	9.49	36	3.87	51	9.41	Average	5.88
7	2.62	22	6.82	37	6.06	52	22.35		
8	0.1	23	5.44	38	24.76	53	5.02		
9	2.34	24	4.82	39	11.99	54	6.19		
10	9.86	25	7.57	40	5.2	55	9.62		
11	4.03	26	4	41	1.33	56	4.37		
12	2.19	27	4.97	42	6.31	57	15.12		
13	6.05	28	0.33	43	3.4	58	8.27		
14	2.1	29	4.44	44	2.57	59	18		
15	3.23	30	1.19	45	4.87	60	8.24		

## Conclusions

ML algorithms are extremely useful in the area of prosthetics. However, it is important to be able to select the optimal algorithm for the right task and the correct training data set. There exist many types of prosthetics that require advanced coding, and being able to explore the capabilities of PbD using ML algorithms such as ANN can provide insight into their suitability for other applications. The KNN algorithm seemed to be outperformed by the other algorithms, but more data regarding more distinct objects would need to be gathered to solidify this conclusion. The specialized ANNs performed adequately considering the variety of the objects and shows potential for greater performance when more data is gathered.

## Limitation and Future Work

Overall improvements could be made to capture more of the motion of the Master Glove. Likewise, improvements can be made to limit the Master Glove in a way to ensure that the human hand motion can be reproduced by the artificial hand. For instance, developing a glove with increased similarity to the characteristics of the robotic hand would help in the application of the experiment in distinguishing shapes with the hand. This study was not performed with the actual robotic hand, and more data would be required to evaluate if there would be an issue in classifying shapes with medium sized objects. Similarly, experimenting with the actual robotic hand would help verify the method chosen for best distinguishing geometry. More data containing additional varied lengths in diameter can also be gathered to fill in any gaps in the data that could have led to misclassification. The effect of abduction and adduction of the fingers can be further investigated to evaluate if there is a significant difference in the detection of different geometries. In this experiment, KNN used only one type of distance metric, Euclidean, and further study is needed to test if the classification ability improves with other metrics. One last improvement would be to explore other methods in finding the optimal setting of the ANN and compare them to determine their relative effectiveness.

## References

- [1] A Billard et al., "Robot programming by demonstration," in *Springer Handbook of Robotics*, Germany: Springer Berlin Heidelberg, 2008, ch. 59, pp. 1371-1394
- [2] P. Langley and H. A. Simon, "Applications of machine learning and rule induction," *Communication of the ACM*, vol. 38(11), 1995, pp. 54-64.
- [3] M. Kubat et al., "Machine learning for the detection of oil spills in satellite radar images," in *Machine Learning*, vol. 30(2-3), 1998, pp. 195-215.

- [4] F. Dieterle et al., "Urinary nucleosides as potential tumor markers evaluated by learning vector quantization," in *Artificial Intelligence in Medicine*, vol. 28(3), 2003, pp. 265-279.
- [5] S. Smith, "Neural Networks (and more!)," *The scientist and engineer's guide to digital signal processing*, San Diego, USE: California Technical Pub., 2002, ch. 26, pp. 451-480.
- [6] G. Zhang et al., "Forecasting with artificial neural networks: The state of the art," in *International Journal Forecasting*, vol. 14(1), 1998, pp. 35-62.
- [7] T. Joachims, "Text categorization with support vector machines: Learning with many relevant features," in *European Conference on Machine Learning*, vol. 1398, Chemnitz, Germany, 1998, pp. 137-142.
- [8] M. Sewell. (2008, September). *VC Dimension*. [Online]. Available: <http://www.svms.org/vc-dimension/>
- [9] National Instruments. (2010, June). *NI Vision 2010 for LabVIEW Help* [online]. Available: [http://zone.ni.com/reference/en-XX/help/370281M-01/imaqvision/imaq\\_train\\_nearest\\_neighbor/](http://zone.ni.com/reference/en-XX/help/370281M-01/imaqvision/imaq_train_nearest_neighbor/)
- [10] N. Latysheva. *Implementing your own k-nearest neighbour algorithm using Python* [online]. Available: <https://blog.cambridgecoding.com/2016/01/16/machine-learning-under-the-hood-writing-your-own-k-nearest-neighbour-algorithm/>
- [11] R. Zöllner et al., "Understanding users intention: Programming fine manipulation tasks by demonstration," in *Intelligent Robots and Systems*, 2002, pp. 1114-1119.
- [12] R. Zöllner et al., "Programming by demonstration: Dual-arm manipulation tasks for humanoid robots," in *Intelligent Robots and Systems*, vol. 1, Japan, 2004, pp. 479-484.
- [13] U. Shah, *HRI using Knowledge Based Approach*, M.S. thesis, Dept. Mechanical Eng., Univ. of Texas., Arlington, TX, 2016.
- [14] K. Hornik, et al., "Multilayer feedforward networks are universal approximators," in *Neural Networks*, vol. 2(5), 1989, pp. 359-366.
- [15] National Instruments. (2013, June). *NI Vision 2013 Concepts Help* [online]. Available: <http://zone.ni.com/reference/en-XX/help/372916P-01/nivisionconcepts/supportvectormachines/>

## Appendix

### Hand Motions

The actions shown below exhibit the limitations of the robotic hand that must be considered while collecting data regarding grasping patterns. The robotics hand is controlled by a pulley system and is only able to bend the fingers in one direction. Moreover, the spaces of the finger will always remain because the joints are not flexible. The hand is also stationery with no wrist movement.

#### Finger Abduction and Adduction



Figure 13: Here is the depiction of the movement of the finger abducting outward (on the left) and adducting inward (on the right) which the prosthetic cannot replicate.

#### Thumb Abduction and Adduction



Figure 14: Here is the depiction of the movement of the thumb abducting outward (on the left) and adducting inward (on the right) which the prosthetic cannot replicate.

## Thumb Opposition



Figure 15: Here is the depiction of the movement of the thumb bending inward, which the prosthetic can accomplish with additional bending of the joints of the thumb.

# Teaching Daily Drill Exercises to Visual Learning Instrumentalists

**Adrian Villalobos**

Music Education

Mentor: Dr. John Zastoupil

Music Department



## Abstract

Daily drill exercises are used in all levels of music pedagogy. Kinesthetic and aural learners may find the current implementation of the daily drill beneficial; however, visual learners may not find the repetition of daily drill easily comprehensible. The purpose of this study is to a) analyze various daily drill exercises used in music pedagogy; b) identify their impact on visual learners; and c) develop a methodology for daily exercises to efficiently aid visual learners.

This research specifically works with seven exercises: 1) physical movement while breathing; 2) metered breathing; 3) long tones; 4) slow arpeggios with a reference pitch; 5) isometric articulation; 6) vibrato exercises; and 7) flexibility exercise. Each exercise will be presented in a common format, such as sheet music or a description of what to do. This will be followed by the fundamental goals of each exercise being identified. A method for explaining the objective of the exercise to a visual learner will then be presented and followed by an explanation of why the visual method would be effective. At the conclusion of this section, there will be a method for teaching daily drill exercises to visual learners.

## PART ONE

### Significance of Research

In music programs, students go through daily drill exercises each rehearsal. These exercises work to improve ensemble ability and musicality by developing the core skills student musicians need to perform on their instruments and working toward their technical achievement. For auditory learners, the hearing of how the fundamental



exercises are supposed to be played helps the student work by ear to improve. For kinesthetic learners, the routine of repeating the same tasks improves their coordination and muscle memory. This document presents a method for approaching daily drill in a manner visual learners can efficiently interpret.

## Purpose of the Study

The purpose of this study is to analyze various daily drill exercises used in music pedagogy and identify their effect on visual learners. Across all band programs, numerous warm-ups and daily drill exercises are used. These exercises build and improve the fundamental skills needed to develop a student's technique and musicality. A majority of the time, the exercises help kinesthetic and auditory learners without difficulty. However, the repetition of the daily drill exercises does not always include aspects that visual learners find easily comprehensible. The purpose of this research is to develop a methodology for daily exercises that efficiently aid students who learn through visual means.

## PART TWO

### Review of Literature

#### Background on Learning Styles

The theory of learning styles, the proposition that students have a preferred way of receiving information that is the most beneficial for their learning, remains a debated topic of discussion in modern pedagogy. Most theories trace back to C. G. Jung's work on psychological types, a foundation for the Myers-Briggs Type Indicator. (Pashler et al. 2008. 5-7) Jung identified eight distinct patterns that people use in their mental process and posited that people prefer one pattern over another. These eight psychological attitudes are extraversion, introversion, perceiving, judging, sensing, thinking, intuition, and feeling. (MBITToday) Following years of research, the concept of preferred mental processes gave rise to the idea of cognitive styles.

As early as the 1970's, psychological types switched focus into the pedagogy field. Educators and researchers began identifying how these cognitive styles affected one's ability to learn. However, when compared with both Jung's and Myers's personality types, researchers found that the personality type is the least dominant factor in determining one's learning style, suggesting that this would be limited by the individual's strong and habituated preferences. (Coffield et al. 2004. 59-60) The personality types served as a primary foundation for specific factors that form a student's learning style. As research began focusing on the pedagogical side of psychological preferences, a learning-styles hypothesis developed. (Pashler et al. 2008. 6-8) This hypothesis proposes that a student's learning will be inefficient, or at least not as efficient as it could be, if learners receive instruction that does not take account of their learning style. Similarly, if an individual's education is tailored to their learning style, a higher learning outcome can be attained. While many different variations of learning styles exist, the VARK model is one of the most supported.

The VARK model establishes four main learning styles: visual, aural, reading/writing, and kinesthetic. (Fleming 1995. 1-2) Kinesthetic or tactile learners prefer using all their senses, in their educational experience. Multi-sensory experiences and concrete teaching work best with these types of students. Even complex theories can be grasped in this style of learning through the use of analogies, examples, or metaphors. Active engagement in their learning aids in understanding the subject entirely. In general, these tactile learners are less accommodated in the classroom. (Sarasin 1999. 71-81) However, in the field of music pedagogy, kinesthetic learners benefit from the stimulation of multiple senses and repetition of these stimulations. Through the routine of daily practicing and rehearsals, they form a muscle memory and can interpret the skills they are supposed to work on through this muscle memory.

Similar to kinesthetic learners, reading and writing learners prefer to use multiple senses in their learning. (VARK-learn) They prefer information to be displayed as words. They use their visual sense to read the words and understand their meaning while their tactile sense works toward remembering through writing down the information. The use of both these senses provides an unusual combination for educators to consider. Essays, reports, presentations, and any other text-based input or output serve as effective means of teaching reading/writing learners. In the field of music pedagogy, these learners adapt by writing down words or phrases on their music and exercises to fully understand the information. While teachers rarely reference to these students, the information given to them does accommodate their learning style more than expected.

For aural learners, learning impacts them fully when they are attentive and listening to orally given information. (Sarasin 1999. 43-55) Verbal questioning or focusing, discussions, and lecture prove to be the most efficient for aural learners. Tasks and activities for auditory learners should be broken up into logically ordered pieces. They process information methodically and are very literal in their explanations. Aural learners are the most accommodated in the classroom, as most educators lecture and use pedagogical strategies that auditory learners find especially rewarding. Specifically in the field of music pedagogy, aural learners excel. As most information is broken down into fragments and then built upon, they can quickly grasp a solid understanding of information. They are also able to listen and understand how exercises are supposed to sound, and use this aural memory to try and replicate the sound in their practicing.

## Visual Learners

Visual learners are in some ways the opposite of aural learners, as most cannot gather information merely from hearing it. (Sarasin 1999. 57-69) These students tend to look at the entirety of the concept rather than just its separate characteristics. This type of observational learning can be broken up into four main stages: attention, memory, reproduction, and motivation. (Campos 2005. 15-16) Learners must first pay attention and analyze an action, remember the aspects they observed of that action, and then attempt to reproduce the action. Motivation comes after as an evaluation step to see if the reproduction was accurate. For visual learners to be taught effectively, they must be guided through the steps successfully.

As far as methods for effectively presenting visual information, there are six: investigation, chronicle, expression, communication, inspiration, and envisioning. (Gangwer 2009. 7-8) The investigation method deals with focusing attention and concentration on detail to understand the concept as a whole. The chronicle method is recalling a particular memory or image in a student's mind, similar to taking a photograph, to help record and annotate rapidly changing ideas. The expression method is using a visual stimulant to reveal thoughts and feelings in order to understand an abstract idea. Communication is using an image or report and visualizing the structure, composition, and organization of the information within it. The inspiration method is using the visual stimulus to change a behavior or attitude through reinforcement. Lastly, the envisioning method is allowing the learner to use their imagination to create an individual visual representation of the information given to them. Applying a few of these methods, or at least one, when implementing a visual tool should provide a stable and efficient foundation for learning.

Graphic organizers and glyphs, symbols that convey information nonverbally, prove to be extremely beneficial tools for visual learners. (Gangwer 2009. 49-54) By transmitting the information through a visual means, the likelihood of retention, comprehension, and clarity increases. Examples of effective graphic organizers include thinking maps, cause and effect webs, charts, storyboards, cycles, chains, ladders, Venn diagrams, flow charts, circle charts, word webs, and story webs. Examples of useful glyphs include printed images, single letters and marks, and graphs. Glyphs are non-standard and therefore can range among several innovative forms. As long as an image is illustrating a variety of information and a legend is generated to understand the nature of the visual language, it can be considered a glyph. These visual representations of information aid in the teaching of visual learners by appealing to their preferred learning style.

## Implementation into Music Education

In the field of music pedagogy, visual imagery is not commonly addressed. In fact, according to a study done at multiple high schools, visual preferences were the least common learning style among most students in the pedagogical field. 40% of the students were kinesthetic learners, 31% were auditory learners, and 16% had a mixture of two or more preferred learning styles, leaving only 13% of the students as visual learners. (Dunn and Griggs 1988. 16) Musicians typically fall into the 31%, as they primarily use the aural sense in their learning. (Campos 2005. 15-16) The attainment of artistic skill through observational learning is achievable despite aural being the primary learning style. The focus must be switched to tools and methods specifically designed for visual learners and implemented in music pedagogy. (Gangwer 2009. 76-77) By creating visual representations or descriptive imagery to explain the concepts typically explained aurally, visual learners will have an improved learning experience and retain the information effectively.

The simplest way to integrate the visual tools and methods into the music pedagogy field is by applying it to a basic exercise used in the field. Daily drill exercises are used in music instruction throughout all tiers of education, from primary education to secondary education to post-secondary education. The exercises serve to prepare the

individual musician for additional playing through the rehearsal. Although method books contain various daily drill exercises, it is ideal to tailor routines to the student. (Brown 1981, 77-80) Each exercise serves to isolate and improve an individual skill used in an instrumentalist's musicality. For the purpose of this research, a few key exercises in concepts such as intonation, air support, articulation, and embouchure manipulation will be examined and their intended purpose will be defined.

Intonation is the accuracy of the pitch in a musician. Nearly every daily drill exercise serves to improve intonation in one way or another, but long, sustained notes are an easy way to put emphasis on intonation. Long tone exercises improve tone quality and intonation, as well as develop embouchure strength and endurance. (Brown 1981. 78-79) During the exercise, the musician concentrates on their tone and seeks to improve it. They attempt to maintain good intonation as they continue playing the sustained notes. Stability and consistency of tone are the primary goals in long tone exercises. Similar to long tones, slow arpeggios, while a reference pitch is also sounding, proves to be a useful exercise for intonation.

Air support is the backbone of brass music. Without proper inhalation and exhalation technique, a musician will not be able to accomplish anything. The primary goal of breathing exercises is finding the difference between air compression and pressure and establishing the student's awareness of pressurization of air and the movement speed of air. (Campos 2005. 34) Finding a balance between these two concepts helps create the appropriately active breath used in playing. Practical air support exercises include meter breathing and physical movement while breathing. The three steps of a breath are the inhalation, the suspension, and the release. (Griswold 2008. 28) The lungs fill from bottom to top, with a slight chest expansion to ensure a full breath.

Articulation is the method in which a musician begins and ends his notes. Exercises for articulation focus on teaching proper slurring, legato tonguing, staccato tonguing, articulation speed, consonant and vowel usage, and the proper releases. (Campos 2005. 85-86) Every articulation is broken up into three sections: the attack, the sustain, and the release. Articulation exercises work toward building each section. The consonants "T," "D," "H," and "K," are used to define the attack of the articulation and each is used in particular articulation exercises. The sustainment of the note varies in length depending on the style of articulation. The release is achieved by either a stopping of the air stream or with a tongue. The articulation exercises help define the correct release to use based on the style. All three factors work in tandem to establish an articulation style. Isometric articulation is one of the most efficient exercises for articulation.

Embouchure manipulation can include a multitude of factors, such as flexibility and vibrato. (Brown 1981. 79-80) Embouchure exercises focus on building the muscles around the mouth and controlling them. The two most commonly used flexibility exercises are lip slurs and lip trills. The goal of lip slurs is to increase the range of the musician. Lip trills work on building endurance at all ranges of the instrument. Vibrato exercises work on increasing the consistency of a particular type of vibrato, ranging from hand vibrato, jaw-lip vibrato, diaphragm vibrato, or a combination of these. These types of exercises are the most efficient for enhancing embouchure manipulation ability.

## PART THREE

### Methodology and Results

These exercises all serve as daily drills, tasks that the student should be practicing every day they play on their instrument. The refinement of their skills through these exercises is essential to any successful band program. However, if not all students are understanding the purpose behind these exercises or effectively grasping an idea of what is expected, then perhaps the method in which these exercises are presented is to blame. Although some exercises appeal to some types of learners, music pedagogy would be more effective if educators tailor their teachings to impact all their students, including the visual learners. The following method is one way for the information behind these exercises to be conveyed to visual learning musicians.

#### Methodology

Each exercise will be set up in the same manner. The exercise will be presented in the same format it is normally given to the student, whether that is as sheet music or a description of what to do. The fundamental goals of each exercise will be identified. A method for explaining the objective of the exercise to a visual learner will then be presented. In order to convey the purpose of the exercise, the visual representation needs to emphasize the purpose. An explanation of why the visual method would be effective would then follow. At the conclusion of this section, there will be a method for teaching daily drill exercises to visual learners.

The exercises broken down will be metered breathing, physical movement while breathing long tones, slow arpeggios with a reference pitch, isometric articulation, flexibility exercises, and vibrato exercises. Each has already been explained slightly in the literature review but will be explained further in this section. The four main categories of these exercises are intonation, air support, articulation, and embouchure manipulation.

#### Physical Movement while Breathing

Multiple exercises fall into this category. They are mostly explained in an aural form, by instructing the students what to do. One example is having the students move one hand onto their stomachs in order to feel the expansion during the inhalation.

#### *Purpose*

The purpose of these exercises is to be physically aware of what needs to take place during a successful breath. The hand-on-stomach exercise focuses on the expansion needed for a full inhalation. Students can focus on making their stomachs expand as much as possible.

#### *Effectiveness*

By using the imagery of something common, like blowing up a balloon, the visual learner now has a visual image to strive for and understand (see Figure 1). The purpose of this exercise is to be aware of the expansion that is supposed to occur during a breath. By asking the student if their stomach grows bigger like a balloon, the visual learner can have a defined idea of the expansion they are looking to achieve.

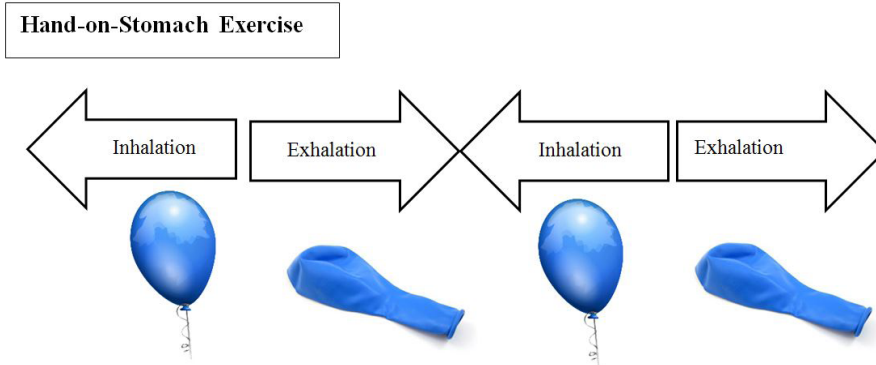

Figure 1: Visual representation of hand-on-stomach exercise.

### Meter Breathing



#### *Purpose*

This exercise is normally explained aurally by telling the students to breathe in for a certain number of beats, usually four, and exhaling for an increasing number of beats. This exercise serves to increase control over the air speed a student uses. By keeping the inhalation and release the same, the student focuses on creating an active air support during the suspension. Another skill emphasized in this exercise is the constant flow of air in and out of the students' bodies.

#### *Effectiveness*

The inhalation and release remain the same, which is why the arrows in Figure 2 are similar. However, the suspension is increasing by four beats every cycle. The graph shows how the air is supposed to remain constant throughout the varying durations. The small arcs to the left represent the immediate change between the inhalation and exhalation, visualizing the concept of a constant flow of air, either in or out, throughout the exercise.

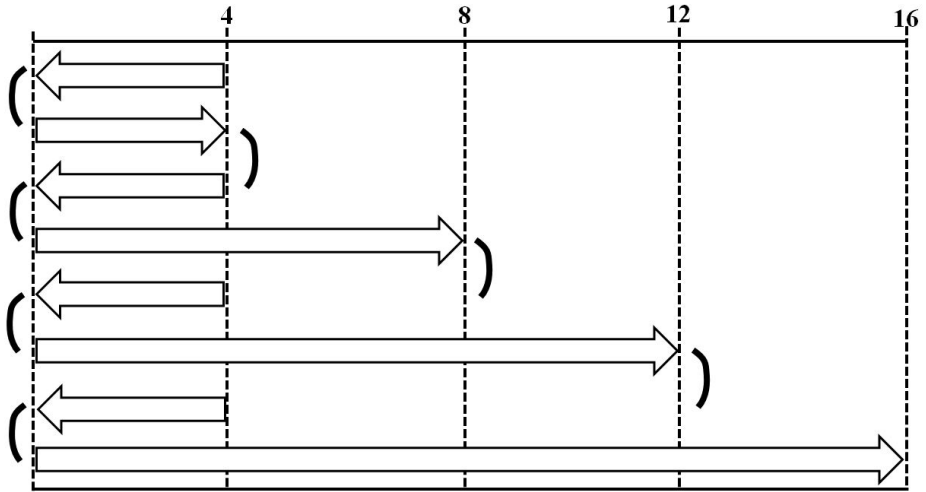

Figure 2. Visual representation of the meter breathing exercise.

## Long Tone Exercises



### *Purpose*

Long tone exercises improve tone quality and intonation, as well as develop embouchure strength and endurance. During the exercise, the musician concentrates on their tone and seeks to improve it. They attempt to maintain good intonation as they continue playing the sustained notes. Stability and consistency of tone are the main goals in long tone exercises.

### *Effectiveness*

The goal of the student is to play consistently for a sustained amount of time. The rectangles in Figure 3 represent the consistency of the sound. The single lines going halfway through each rectangle represent the pitch they are attempting to remain at throughout the duration of the exercise.

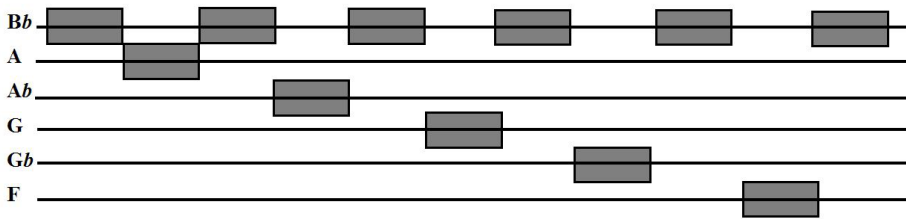

Figure 3. Visual Representation of long tone exercises.

### Slow Arpeggios with a Reference Pitch

While a Bb is being played on piano or a tuner:



### Purpose

Arpeggio exercises like this improve tone quality and intonation. During the exercise, the musician concentrates on their tone and maintains good intonation as they continue to tune the rest of the partials. Like long tone exercises, stability and consistency of tone are the main goals in arpeggio exercises.

### Effectiveness

As with the above long tone exercise, the goal of the student is to play with intonation. This time the student is outlining the triad within the arpeggios, ensuring that all notes in that key are in tune. The rectangles in Figure 4 represent the consistency of the sound. A single line going halfway through a rectangle represents the pitch students are attempting to remain at throughout the duration of the exercise. With only one pitch being referenced, Bb in this case, the lines go through only the Bb rectangles.



Figure 4. Visual Representation of the arpeggio exercise.



## Isometric Articulation

### *Purpose*

This type of articulation exercise works toward having the student identify and execute the different types of articulations. The meter and the rhythm is kept the same to emphasize the importance of the differing articulations. Accented notes have a stronger attack than a regular note, while having a similar sustainment. Marcato notes have a stronger attack than a regular note, but a shorter sustainment and a more defined release. Staccato notes have a similar attack to regular notes, however the sustainment is shorter and the release is defined. Tenuto notes have a lighter attack and a longer sustainment than regular notes. The exercise moves between articulations to aid the student in playing each distinct articulation direction.

### *Effectiveness*

Since it is the style of articulation changing, we must emphasize this in the representation shown in Figure 5. To demonstrate the differences in the styles, assigning a specific shape and shape length to each articulation should prove to be effective. A generic rectangle with about 90% of the beat filled up is a plain quarter note. The enlarged front rectangle represents the increased attack of the accented articulation. The taller, shorter rectangle signifies the accented and separated marcato style. The regular sized rectangle that only covers about 50% of the beat represents the staccato style. The long connected rectangles represent the sustained nature of the tenuto. By visually showing the differences, visual learners can see how they must change each articulation style in order to correctly replicate each desired articulation.

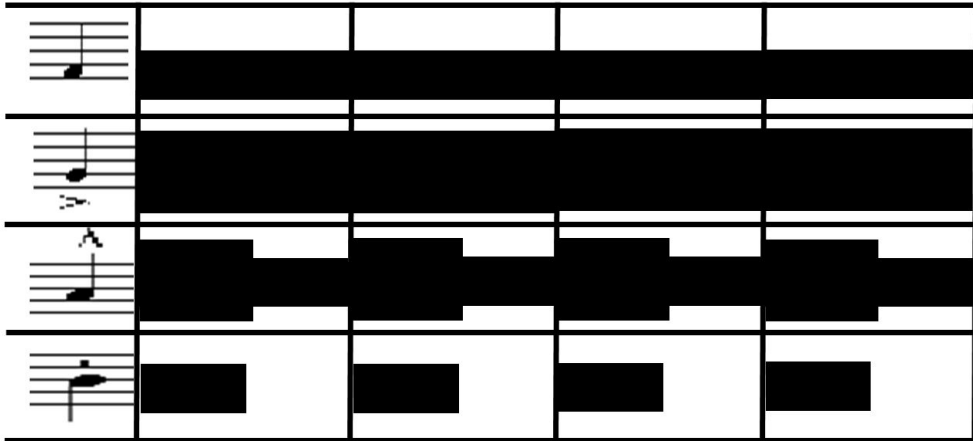

Figure 5. Visual Representation of the isometric articulation exercise.

## Vibrato Exercises



### *Purpose*

The purpose of this vibrato exercise is to use the embouchure to create a consistent and strong vibrato sound. The notes in this exercise are not articulated, but instead a stable pulse through the embouchure bends a sustained note up or down in pitch. These pulses increase in frequency as the rhythm gets faster. The goal is to have stable vibrato from a quarter note pulse to a sixteenth note pulse.

### *Effectiveness*

The goal of the exercise is to create a consistent vibrato. By showing the bending of the pitches as equally above and below the desired intonation, as well as the relation between the notes and the type of pitch bend, Figure 6 conveys how a student should interpret this vibrato exercise.

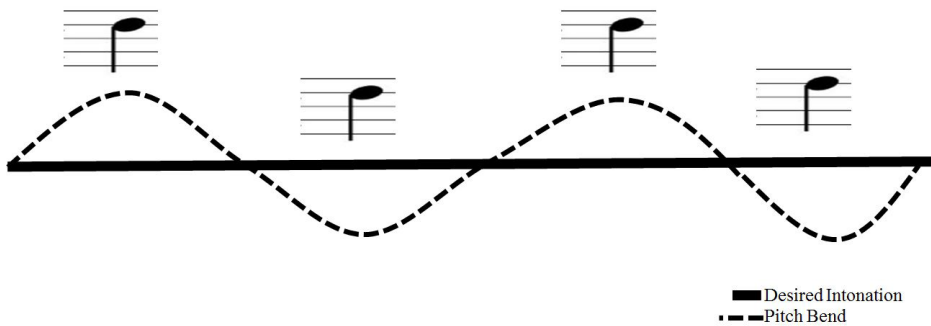

Figure 6: Visual Representation of the vibrato exercise.

## Flexibility Exercises

### *Lip Slurs*



## Effectiveness

The visual images in Figure 7 help convey the goal of the exercise in a vivid and relatable way. For lip slurs, the student is using lower pitches as a baseline intonation and moving their embouchure to a higher position, like a ladder. However, without the lower notes, the lip slur would be ineffective, just as a ladder with the first step missing would not help. The student uses their embouchure to climb higher on their range ladder or to slowly climb back down to the starting note. For lip trills, the embouchure is bouncing back and forth from one note to another. By using the air support behind the first note to spring forward the second note, a see-saw motion can be visualized. The notes trying to reach the same intonation is just like two people on a see-saw trying to reach the same height.

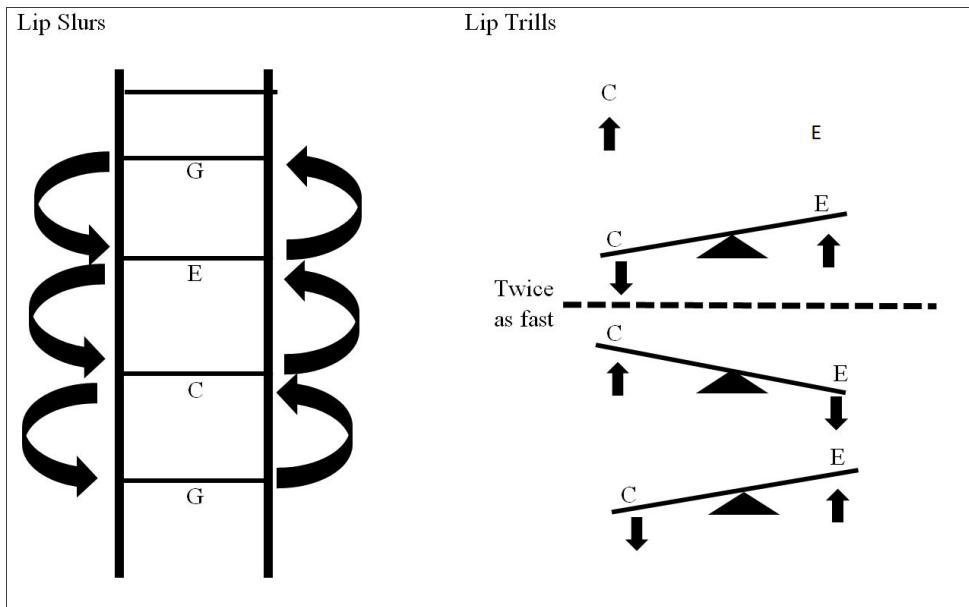

Figure 7. Visual Representation of flexibility exercises.

## PART FOUR

### Conclusion and Need for Further Study

Although in some schools only 13% of the student body identify as visual learners, it is the duty of educators to teach and instruct these students. The exercises described above illustrate possible methods to reach these visual learners. The application and success of these methods would require further research. The methods could be expanded to include other exercises, such as scales and chromatic exercises, chorales, or

rhythm exercises. The application of these methods to other aspects of music pedagogy, such as balance within an ensemble, dynamics, or music theory, would need further research as well.

This research brought to light how little educators consider their visual learners. In music specifically, visual learners must work harder to understand information that is presented clearly to the other types of students. This research should provide a foundation to correct this issue. Unfortunately, educators generally teach in the style they are most accustomed to rather than working to impact all of their students. Methods such as this should bring to light this issue and work toward improving the presentation style in which educators provide information.

## Bibliography

- Brown, Merrill. *Teaching the Successful High School Brass Section*. West Nyack, NY. Parker Publishing Company, Inc. 1981. 77-80, 99.
- Campos, Frank G. *Trumpet Technique*. New York, NY. Oxford University Press, Inc. 2005. 15-16, 30-107.
- Coffield, Frank. Moseley, David. Hall, Elaine. Ecclestone, Kathryn. "Learning Styles and Pedagogy in Post-16 Learning: A Systematic and Critical Review." *Learning and Skills Research Centre* (2004): 55-60. Accessed June 13, 2016. <http://skills.nl/lerenlerenu/bronnen/Learning%20styles%20by%20Coffield%20e.a..pdf>
- Dunn, Rita. Griggs, Shirley A. *Learning Styles: Quiet Revolution in American Secondary Schools*. Reston, VA. National Association of Secondary School Principals. 1988. 2-4, 16.
- Fleming, Neil D. "I'm different; not dumb. Modes of presentation (VARK) in the tertiary classroom." Zelmer, A., (ed.) *Research and Development in Higher Education, Proceedings of the 1995 Annual Conference of the Higher Education and Research Development Society of Australasia (HERDSA)*. HERDSA, Volume 18. 1995. pp. 308-313.
- Gangwer, Timothy. *Visual Impact, Visual Teaching: Using Images to Strengthen Learning*. Thousand Oaks, CA. Corwin Press. 2009. 7-8, 49-54, 73-77.
- Griswold, H. Gene. *Teaching Woodwinds*. Upper Saddle River, NJ. Pearson Education, Inc. 2008. 16-35.
- Hatami, Sarvenaz. "Learning Styles." *ELT Journal*. Volume 67 Issue 4. 488-490. Accessed June 22, 2016. <http://eltj.oxfordjournals.org.ezproxy.uta.edu/content/67/4/488.full>

- Kirby, John. Moore, Phillip. Schofield, Neville. "Verbal and Visual Learning Styles." *Contemporary Educational Psychology* Volume 13 (1988): 169-184. Accessed June 23, 2016. [http://ac.els-cdn.com.ezproxy.uta.edu/0361476X88900173/1-s2.0-0361476X88900173-main.pdf?\\_tid=81af499a-4d33-11e6-a71a-00000aacb35d&cdnat=1468879609\\_7ab4ffb58f737373922041194f2cc936](http://ac.els-cdn.com.ezproxy.uta.edu/0361476X88900173/1-s2.0-0361476X88900173-main.pdf?_tid=81af499a-4d33-11e6-a71a-00000aacb35d&cdnat=1468879609_7ab4ffb58f737373922041194f2cc936)
- MBTIToday. "Carl Jung & Psychological Types." Accessed June 16, 2016. <http://mbtitoday.org/carl-jung-psychological-type/>
- Pashler, Harold. McDaniel, Mark. Rohrer, Doug. Bjork, Robert. "Learning Styles: Concepts and Evidence." *Psychological Science in the Public Interest* Volume 9 Number 3 (2008): 5-8. Accessed June 12th, 2016. [http://steinhardtapps.es.its.nyu.edu/create/courses/2174/reading/Pashler\\_et\\_al\\_PSPI\\_9\\_3.pdf](http://steinhardtapps.es.its.nyu.edu/create/courses/2174/reading/Pashler_et_al_PSPI_9_3.pdf)
- Sarasin, Lynne Celli. *Learning Style Perspectives: Impact in the Classroom*. Madison, WI. Atwood Publishing. 1999. 33-35, 43-83.
- VAR-k-learn. "The Vark Modalities." Accessed June 13, 2016. <http://vark-learn.com/introduction-to-vark/the-vark-modalities/>

# Effects Of Synthesis Parameters On Polydopamine Nanoparticle Size

**Prince Osuchukwu**

Biomedical Engineering

Mentor: Dr. Kytai Nguyen

PhD Student Mentors: Serkan Yaman and Nikhil Pandey

Department of Biomedical Engineering

## Abstract

Polymer nanoparticles (NPs) have recently been synthesized and used as drug carriers to treat various diseases including cancers and cardiovascular diseases. One of the polymer NPs developed in our group, polydopamine nanoparticles (PDA NPs), has the potential therapeutic advantage in the combined therapy, especially chemo-photo therapy, to treat cancers. Since the NP size, which is affected by various variables in the NP formulation process, plays an important role in the therapeutic efficacy, we specifically investigated the effects of major variable factors on the size of PDA NPs in this research. We identified five controllable factors that could affect the NP size and then used a design expert software (Stat Ease) to design a combination of necessary experimental run conditions that vary each of the five variable factors over 2 ranges of values (low and high). The design expert approach reduces the numbers of experiments or runs for analyzing effects of many factors. In our case, 8 different synthesis conditions were designed and performed to assess the effects of formulation variables on the NP size instead of 32 runs (2 levels for five factors) for full design. The NP size for each run was measured, and results were analyzed using the software to obtain a size-to-factor relation. Our analysis revealed that the ammonia-water ratio was the most significant factor affecting the size of the PDA NPs. Based on the designed equation resulting from the factorial analysis, we could successfully synthesize PDA NPs with the average diameter of about 250 nm. Results from this work could generate experimental conditions that yield PDA NPs of a required size for therapeutic efficacy studies in the future.



## Introduction

Cancer will be accountable for 1,685,210 new cases and 595,690 deaths in the United States in 2016. Conventional methods to treat cancer via chemotherapy, radiation therapy and surgical methodology lack the specificity to differentiate between healthy and cancerous cells, which results in significant damage to healthy cells in parallel. To address this limitation, the field of nanomedicine and drug delivery provides solutions in the form of developing nanoparticles (NPs) that can specifically target the toxic chemotherapeutics to cancerous cells in the body while having the ability to shield the healthy cells from this toxicity. With their small size, NPs can penetrate deep into tumor tissues and thus are more effective in carrying the chemotherapeutic drugs to cancer cells for their killing. [1][2][3]

NPs are structures whose size ranges in at least one dimension in a nanoscale according to the definition from National Nanotechnology Initiative (NNI). These small particles, because of their size, when used as nanocarriers in drug delivery systems, can more easily be up-taken into tissues and blood vessels than larger carriers. Consequently, these NPs are very useful in medicine in terms of delivering drugs and payloads too difficult to reach targeted parts of the body. Furthermore, these NPs also have high surface-to-volume ratios, which offer opportunities to attach antibodies to chemical groups on the surface of NPs and make them target very specific areas in the body.

NPs in tumor treatment are also useful in making use of the unique pathophysiology of tumors, which have a leaky vasculature and thus enable NPs to selectively permeate the tumors and be retained in the tumors for longer periods of time, a phenomenon called the enhanced permeability and retention effect. [3]

The size of NPs also effects their circulation inside the body. Smaller NPs (5-10 nm) can be rapidly filtered by the liver and kidney, while larger particles (<250 nm) can be rapidly phagocytized and cleared from circulation. For effective drug delivery, NPs should circulate in the body for longer periods of time to have maximum interactions with their target tissue. The optimal size for drug delivery applications for NPs lies between 100 and 300 nm. [3]

Given all these size-dependent effects on NP interactions inside the body, it is important to formulate 100-300 nm size NPs for drug delivery applications. Some NPs have the capability of absorbing light radiation and converting this light energy to localized heat. This “photothermal effect” can be utilized to treat tumors by ablating them with heat, thus destroying malignant cells in a process called photohyperthermia [4]. This technique of photohyperthermia using NPs is particularly useful as it is noninvasive and can be easily applied using an external light source. It is useful for a nanomaterial to possess photothermal properties while being responsive to near infrared light (NIR) (650-1100 nm) as NIR light can penetrate biological tissues more efficiently than visible light (400-700 nm) as the tissues scatter less light at longer wavelengths [5][6][7].

In this project we chose to work on the synthesis of PDA NPs as polydopamine has a unique ability to absorb NIR radiation and convert the absorbed light into heat,



thus the NPs synthesized from polydopamine possess excellent potential to be used as photothermal agents for cancer therapy. These NPs can also serve in light-controlled drug delivery systems, providing an appealing means to direct and control drug release spatiotemporally at the site of interest with high specificity.

We synthesized PDA NPs in alcohol and water mixed solvent systems, and our goal was to synthesize NPs in sizes that can be useful for drug delivery (100-300 nm). We characterized the effects of different reaction parameters on the size of the synthesized NPs and tried to derive a relation between the reaction parameters and the NP size.

## Significance

Polydopamine has various applications in the energy, environmental and biomedical fields. Its applications in biomedical science include but are not limited to antimicrobials, in vivo cancer diagnosis and photothermal therapy, bioimaging, and drug delivery.

The success of this project can lead to better understanding the way formulation variables affect the size of PDA NPs and will help us generate experimental methods that we can use to synthesize a desired size of PDA NPs for various applications. The success of this project will also pave the way to make NIR light-based photothermal drug delivery systems in the size range of 100-300 nm.

## Experimental Methods

**Materials:** All chemicals were purchased from Sigma Aldrich and were used without modification: dopamine hydrochloride, methanol, ammonia hydroxide (aqueous), hydrochloric acid, and deionized (DI) water.

## Synthesis of Polydopamine Nanoparticles

PDA NP synthesis was carried out in water-alcohol mixed solvent. Various PDA NP synthesis experiments were performed by varying ratios of formulation conditions as shown in Table 1. In a typical experiment (Figure 1), a 40-ml water-methanol mixed solvent was prepared at methanol-water percentages of 10% or 50%. To this mixed solvent system, aqueous ammonium hydroxide was added at 0.25% or 2.0%. The pH of the solution was then set to either 7 or 9, followed by the addition of dopamine hydrochloride at 0.75 mg/ml or 1.75 mg.ml. The final reaction was then allowed to proceed for 4 or 20 hours at a stir rate of 750 rpm. After the reaction was complete, the NPs were centrifuged at 15000 rpm for 30 minutes using a Hitachi ultracentrifuge and washed with DI-water, and the size of these NPs was further assessed using dynamic light scattering (DLS).

Factor	Low Level	High Level	Response Variable
Dopamine Concentration (mg/ml)	0.75	1.75	Nanoparticle Size
Reaction Time (Hrs)	4	20	
pH	7	9	
Alcohol:Water %	10	50	
Ammonia:Water %	0.25	2	

Table 1: The various factors used in the synthesis of PDA NP and their levels of variances.

### Design of Experiments for Polydopamine Nanoparticle Synthesis

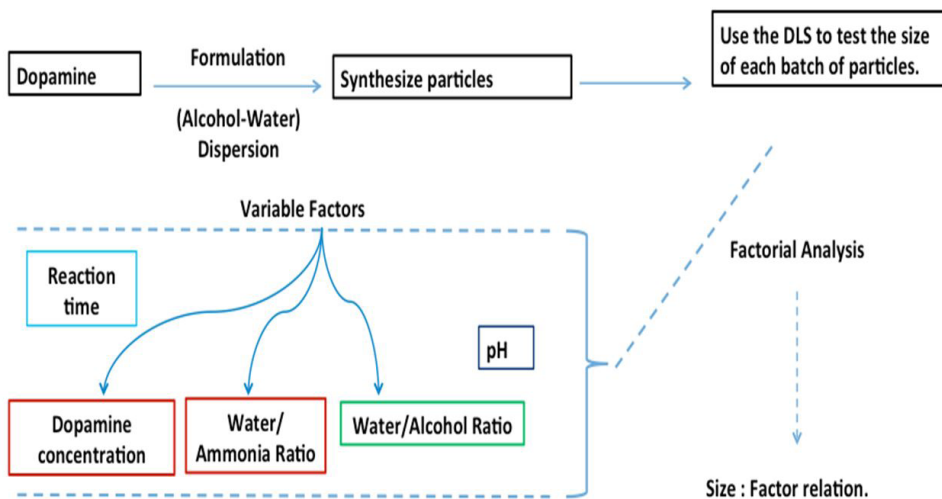

Figure 1: My Study Design –The main overview of the experimental methodology of the research project.

## Experiment Results

The protocol for PDA NP was designed around a factorial analysis scheme. We used the statistical software Design of Experiments (DOE) to design a set of experiments, which varied each of the factors over a range of values. As shown in Figure 1, I used DLS to measure the size of NPs from each of the experiments and then conducted factorial analysis on results of our experiments with the help of DOE to predict how each studied factor relates to the size of the NPs (size-factor relation).

Run	F1	F2	F3	F5	F6	Response Variable
	Dopamine (mg/mL)	Reaction Time (Hrs)	pH	Alcohol:Water (%v/v)	Ammonia:Water (%v/v)	Particle Size (nm)
1	0.75	20.00	9.00	10.00	0.25	945
2	1.75	4.00	7.00	10.00	0.25	583
3	0.75	4.00	7.00	50.00	2.00	911
4	0.75	20.00	7.00	10.00	2.00	866
5	1.75	20.00	9.00	50.00	2.00	445
6	1.75	20.00	7.00	50.00	0.25	501
7	1.75	4.00	9.00	10.00	2.00	333
8	0.75	4.00	9.00	50.00	0.25	692

Table 2: The sizes of nanoparticles obtained in each of the 8 different conditions generated by DOE. F = Factor

Factor	Low Level	High Level	Relative Significance
Ammonia:Water %	0.25	2	1
Dopamine Concentration (mg/ml)	0.75	1.75	2
Reaction Time (Hrs)	4	20	3
pH	7	9	4
Alcohol:Water %	10	50	Not Significant

Table 3: Relative significance of factors on polydopamine nanoparticle size.

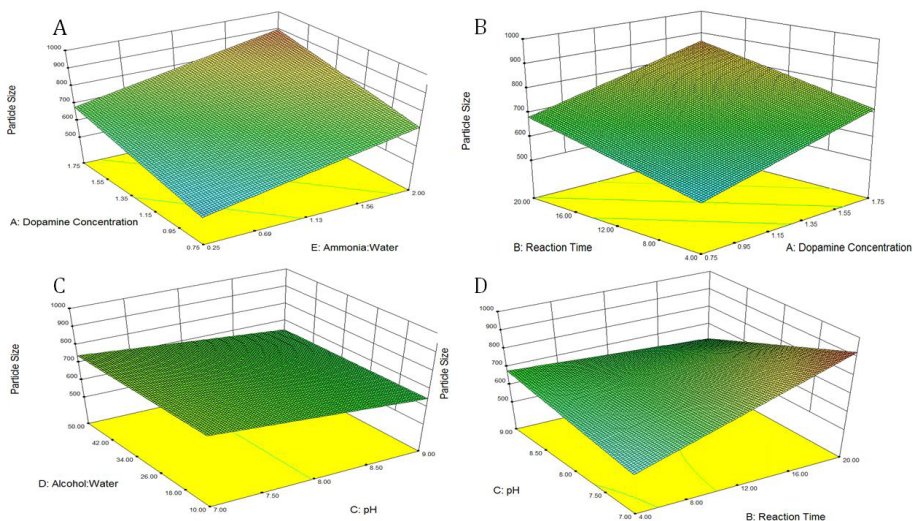

Figure 2: 3D plot of the effect of multiple factors on the size of PDA NP. A) Effect of dopamine concentration and ammonia-water ratio on PDA NP size. B) Effect of reaction times and dopamine concentrations on PDA NP size. C) Effect of alcohol-water ratio and pH on PDA NP size. D) Effect of pH and reaction times on PDA NP size.

### Predictive Equation (Equation 1)

$$\text{Particle Size} = -678.40893 + 182.75000 * (\text{Dopamine Concentration}) + 115.59375 * (\text{Reaction Time}) + 112.32500 * (\text{pH}) + 123.68571 * (\text{Ammonia:Water}) - 13.28125 * (\text{Reaction Time}) * (\text{pH})$$

### Predictive Equation Validation:

Software-Optimized Experimental Conditions							
Dopamine (mg/mL)	Reaction Time (Hrs)	pH	Alcohol-Water (%v/v)	Ammonia-Water (%v/v)	Predicted Particle Size (nm)	Experimental Particle Size (nm)	%Error
0.20	4.00	7.00	0.00	0.10	245	254 ± 97	3.92

Table 4: Experimental conditions and results based on software calculations for PDA NPs optimizing

## Discussion

PDA NPs are formed by the oxidation of monomer dopamine in the presence of oxygen under alkaline conditions in a mixed solvent dispersion [7]. In our studies we chose water-methanol as the mixed solvent system for polymerization of dopamine because it has been found that polymerization can be better controlled in the presence of methanol [8].

In this synthesis process of PDA NPs, there were many formulation variables that could be controlled and that have a direct effect on the size of the NP. We chose 5 factors that would be mostly important in affecting the NP size: dopamine concentration, water-alcohol ratio, rate of stirring, total reaction time, and the reaction pH. We then used a 2-levels/5-factors design to formulate experimental run conditions that would vary these 5 factors over 2 different concentrations or values (High and Low). In this series of synthesis experiments, we then formulated PDA NP at varying experimental conditions and recorded the NP size using DLS methods at the end of each experiment.

When dopamine hydrochloride is added to the solution the color of the reaction turns from clear to a pale brown and becomes increasingly dark as the reaction proceeds. When we analyzed the NP sizes against the variable factors, we found 4 of the 5 initial factors selected for this study had a significant effect ( $p < 0.05$ ) on the size of PDA NPs (Table 3). The water-ammonia ratio had the most significant effect on the size of PDA NPs; however, water-alcohol ratio was not a significant factor affecting the size of NPs.

In our analysis using the design expert software, we could also generate a predictive equation (Equation 1) that relates the size of PDA NPs to the various significant factors affecting the NP size. We tested this equation using experimental conditions that the software optimized (Table 4) for a NP size of 245 nm in diameter. We ran those experimental conditions and the synthesized PDA NPs were  $254 \pm 97$  nm in size. It was important to note that the % error between the predicted and experimental PDA NP size was less than 5%.

The overall analysis of the data revealed some major trends between the 4 significant factors (ammonia-water ratio, dopamine concentration, pH, reaction time) and the NP size (Figure 2). Overall we saw that PDA NP size tends to decrease at lower ammonia-water ratio and lower dopamine concentrations (Figure 2A). Also particle size tends to decrease at lower reaction times. The alcohol-water ratio does not affect the NP size much; however, the interaction between alcohol-water ratio and pH suggests that higher alcohol-water ratio and higher pH tend to cause an increase in particle size (Figures 2B and 2C). Reaction time and pH had an interaction effect on the particle size where the particle size decreased either at higher pH and increased reaction times or at lower pH and decreased reaction times (Figure 2D).

## Conclusion & Recommendations & Future Work

The experimental design proved useful in the optimization process of PDA NP. Analysis of the data reflects relationship of NP size in variance with pH, alcohol-water %, ammonia-water %, and reaction time. Based on optimized experiments, smaller size

characteristics are better suited at lower pH and lower reaction times or a larger pH with a greater reaction time and in all cases a lower water-ammonia ratio.

This research investigation allowed us to study the size-factor relationship of the formulation factors involved in the synthesis of PDA NP. These generated results have proven useful in furthering our understanding of the controllable synthesis of PDA NP to a desired size. Our future plan is to further synthesize PDA NPs in the size range of 150-200 nm and characterize their photothermal properties and ultimately apply them as drug delivery vehicles for a combined therapy, especially chemo-photothermal therapy, to treat cancers.

## Bibliography

1. Yan J, Yang L, Lin M, Ma J, Lu X, Lee PS. *Polydopamine spheres as active templates for convenient synthesis of various nanostructures*. *Small*. 2013;9(4):596-603.
2. De Jong WH, Borm PJ. Drug delivery and nanoparticles: Applications and hazards. *International journal of nanomedicine*. 2008;3:133.
3. Cho K, Wang XU, Nie S, Shin DM. *Therapeutic nanoparticles for drug delivery in cancer*. *Clinical cancer research*. 2008;14(5):1310-1316.
4. Liu Y, Ai K, Lu L. Polydopamine and its derivative materials: Synthesis and promising applications in energy, environmental, and biomedical fields. *Chemical reviews*. 2014;114(9):5057-5115.
5. Wilczewska AZ, Niemirowicz K, Markiewicz KH, Car H. Nanoparticles as drug delivery systems. *Pharmacological reports*. 2012;64(5):1020-1037.
6. Blanco E, Shen H, Ferrari M. Principles of nanoparticle design for overcoming biological barriers to drug delivery. *Nature Biotechnology*. 2015;33(9):941-951. doi:10.1038/nbt.3330.
7. Liu Y, Ai K, Liu J, Deng M, He Y, Lu L. Dopamine-melanin colloidal nanospheres: An efficient Near-Infrared photothermal therapeutic agent for in vivo cancer therapy. *Advanced Materials*. 2013;25(9):1353-1359.
8. Kohri M, Nannichi Y, Taniguchi T, Kishikawa K. Biomimetic non-iridescent structural color materials from polydopamine black particles that mimic melanin granules. *Journal of Materials Chemistry C*. 2015;3(4):720-724.

## Further Reading

Cheng L, Yang K, Chen Q, Liu Z. Organic stealth nanoparticles for highly effective in vivo near-infrared photothermal therapy of cancer. *ACS nano*. 2012;6(6):5605-5613.

- Haba Y, Kojima C, Harada A, Kono K. Control of temperature-sensitive properties of poly (amidoamine) dendrimers using peripheral modification with various alkylamide groups. *Macromolecules*. 2006;39(21):7451-7453.
- Ho C, Ding S. The pH-controlled nanoparticles size of polydopamine for anti-cancer drug delivery. *Journal of Materials Science: Materials in Medicine*. 2013;24(10):2381-2390.
- Jiang X, Wang Y, Li M. Corrigendum: Selecting water-alcohol mixed solvent for synthesis of polydopamine nano-spheres using solubility parameter. *Scientific reports*. 2015;5.
- Jiang X, Wang Y, Li M. Selecting water-alcohol mixed solvent for synthesis of polydopamine nano-spheres using solubility parameter. *Scientific reports*. 2014;4:6070. doi:10.1038/srep06070.
- Liu F, He X, Zhang J, Chen H, Zhang H, Wang Z. Controllable synthesis of polydopamine nanoparticles in microemulsions with pH-activatable properties for cancer detection and treatment. *Journal of Materials Chemistry B*. 2015;3(33):6731-6739.
- Lynge ME, van der Westen R, Postma A, Städler B. Polydopamine—a nature-inspired polymer coating for biomedical science. *Nanoscale*. 2011;3(12):4916-4928.
- Mrówczyński R, Bunge A, Liebscher J. Polydopamine—An organocatalyst rather than an innocent polymer. *Chemistry—A European Journal*. 2014;20(28):8647-8653.
- Qi R, Gao Y, Tang Y, et al. PEG-conjugated PAMAM dendrimers mediate efficient intramuscular gene expression. *The AAPS Journal*. 2009;11(3):395-405.
- Shiraishi Y, Miyamoto R, Zhang X, Hirai T. Rhodamine-based fluorescent thermometer exhibiting selective emission enhancement at a specific temperature range. *Organic Letters*. 2007;9(20):3921-3924.
- Stolik S, Delgado JA, Perez A, Anasagasti L. Measurement of the penetration depths of red and near infrared light in human “ex vivo” tissues. *Journal of Photochemistry and Photobiology B: Biology*. 2000;57(2):90-93.
- Sun T, Zhang YS, Pang B, Hyun DC, Yang M, Xia Y. Engineered nanoparticles for drug delivery in cancer therapy. *Angewandte Chemie International Edition*. 2014;53(46):12320-12364.
- Yan J, Yang L, Lin M, Ma J, Lu X, Lee PS. *Polydopamine spheres as active templates for convenient synthesis of various nanostructures*. *Small*. 2013;9(4):596-603. <http://onlinelibrary.wiley.com/doi/10.1002/sml.201201064/abstract>. Accessed April 6, 2016. doi: 10.1002/sml.201201064.

# Identification of the Plateau of Cadmium Extraction from an Aquatic Medium by Invasive Macrophyte: *Eichhornia crassipes*

**Micalah Spenrath**

Earth & Environmental Sciences



Mentor: Ashanti Johnson, Ph.D.

Department of Earth and Environmental Sciences

## Abstract

Each passing year elevates the amount of heavy metals in the environment; heavy metals are extremely deleterious compounds because of their high toxicity to organisms, persistence in the environment and their difficult, expensive removal. Phytoremediation is a means of ameliorating the condition of the environment by means of flora that exhibit the tendency to accumulate or immobilize heavy metals or other contaminants. Utilizing an aquatic macrophyte, *Eichhornia crassipes*, as a phytoremediant of a select heavy metal, cadmium, has been shown to be experimentally viable, less environmentally disruptive and more economical than the conventional methods. To further understand the time required to optimize cadmium uptake and minimize the potential for rerelease of contaminants, *E. crassipes* was studied to identify the plateau of cadmium extraction. The experimental plants were housed in five parts per million (ppm) cadmium in deionized water and remained in that environment for the duration of the experiment: 144 hours. Other conditions were created to isolate variables such as sorption and adsorption of cadmium to the experimental containers and any metal output from the plants and containers. Water and biomass samples were collected. This investigation is currently ongoing.



## 1. Introduction

Heavy metal contamination of the environment is a severe and growing problem in an increasingly industrial world as heavy metal concentrations are compounded with each passing year (Rai et al. 2002; Govindasamy et al. 2011). Heavy metals are of environmental concern because of their notable toxicity to living organisms, their lethality in small quantities, their persistence and accumulation in many environmental compartments, and their difficult removal, which often requires large fiscal contribution and environmental upheaval (Ali et al. 2013).

Phytoremediation is an in situ means of heavy metal removal that functions as a less environmentally disruptive alternative to conventional methods, such as soil incineration, excavation and landfill, and soil washing and flushing; a few of these processes have aquatic equivalents in terms of environmental degradation (Mulligan et al. 2001). In addition to environmental disruption, these processes can warrant the use of chemicals or other noxious compounds that have the potential to create secondary contamination. The use of plants to extract and immobilize various heavy metals, organic solvents, and industrial chemicals from the contaminated medium has been well documented in many different plant families (Ghosh and Singh, 2005).

*Eichhornia crassipes* (water hyacinth), an aquatic and invasive macrophyte, has been investigated thoroughly for this quality; it can extract heavy metals over a spectrum of concentrations—as high as 10,000 times the concentration of the surrounding medium—without exhibiting significant phytotoxic effects and without succumbing to the lethality of heavy metal contamination until high concentrations are reached (Petit et al. 1978; Lu et al. 2004; Tiwari et al. 2007; Jafari 2010; Das et al. 2016). For these reasons, water hyacinth has been identified as a promising candidate to function as a phytoremediant of heavy metals.

Water hyacinth also exhibits advantageous qualities for phytoremediation, such as typical high biomass and a high tolerance for diverse climates. Although useful for phytoremediation, these qualities have led to serious ecological and economical damages. Being an invasive species, *E. crassipes* is well suited to acclimate to and dominate new regions; this typically leads to the reduction of indigenous species diversity (Jafari 2010). However, the diminution of diversity is not the only negative consequence of invasive species invasion. Water hyacinth has been known to procreate, sexually and asexually, in such a way that the population can cover entire expanses of river and in such a density that it blocks the sun from penetrating the surface of the water. This can greatly impact the livelihood of the people that rely on rivers or other waterways for income or sustenance. These negative qualities exhibited by *E. crassipes* make it very desirable to remove from ecosystems as its presence is not beneficial to a healthy ecosystem.

However, for the purposes of phytoremediation, this is a positive quality. After using a plant for remediation purposes in an aquatic medium, it is very likely that the biomass is riddled with hazardous contaminants and therefore must be removed from the polluted region before the plant dies and decomposes; decomposition would release

the stored contaminants back into the environment. Removing a large population of a nonessential—in fact, a crippling—plant will not only relieve the ecosystem of its biological oppressor but also will remove organic solvents, chemicals, or heavy metals simultaneously.

One such nonessential heavy metal is cadmium (Cd); this metal is amalgamated into paints, plastic stabilizers and is the product of industrial processes, such as electroplating and mining (Salem et al. 2000; Pulford and Watson, 2003). Cadmium is in the top five most toxic metals of public health concern (Tchounwou et al. 2012). Its toxicity to humans and wildlife in very low concentrations is due to several factors: the generation of reactive oxygen species, the consequent oxidative stress, the blockage of functional groups in biomolecules, organ damage, and carcinogenesis (APHA et al. 1998; Schutzendubel and Polle 2002; Miretzky 2006; Tchounwou et al. 2012). Cadmium is also known to cause the disruption of endocrine, the interference of calcium regulation in the body, as well as anemia and renal failure. It is currently considered teratogenic and mutagenic (Degraeve 1981; Salem et al. 2000; Awofolu, 2005). In summary, cadmium has many ways of causing lethality. According to the Centers for Disease Control (CDC), a cadmium concentration of 0.009 ppm is “immediately dangerous to health and life” (CDC 2014). This is starkly juxtaposed with the highest environmental concentrations being recorded at approximately 15 ppm (Tchounwou et al. 2012).

The usage of water hyacinth as a phytoremediant of cadmium has been well studied and these scientific endeavors have yielded significant results. *E. crassipes* accumulates cadmium in the roots and aerial tissues in concentrations many times that of the water or soil (Swain et al. 2014). This implies that utilizing water hyacinth in phytoremediation efforts will allow the magnification of the contaminant inside the plant; this will allow greater removal per plant upon harvesting. Water hyacinth increases uptake of heavy metals in a manner that is commensurate to the increase in cadmium concentration in the environment. This particular plant will increase uptake despite an increasing contaminant load; this finding has applications in areas where there is a continual input of contamination. Clearly, the aforementioned findings buttress the position of water hyacinth as one of the most promising phytoremediants.

Although *E. crassipes* exhibits these beneficial remediation qualities, at wilting it will begin to lower the pH of (acidify) the medium through the release of ions and heavy metals back into the environment (Soltan and Rashed 2003). There is a dearth of information regarding the point in time at which this occurs and when the extraction of cadmium plateaus in an aquatic medium. The purpose of this study is to identify the plateau of cadmium extraction from an aquatic medium by water hyacinth in order to optimize cadmium extraction and completely avoid the rerelease of contaminants.

## 2. Materials and Methods

The water hyacinth plants (*E. crassipes*) were obtained from Mountain Creek Lake in Dallas, Texas (32°42'38"N 96°58'48"W)—a local, artificial lake with a heavy industrial presence. The plants were thoroughly washed with tap water to remove aquatic macroinvertebrates and insect larva. Three water hyacinth of comparable size were selected (70±10g); two were individually exposed to 5 mg/L of cadmium in deionized water. The third plant was placed in deionized water that was not supplemented with cadmium and that acted as a control. Two more conditions were created: one with deionized water and the other with 5 mg/L cadmium to determine if any adsorption and desorption occurred without the presence of plants. Utilizing LED growth lamps, the plants underwent a 12-hour photoperiod followed by a 12-hour dark period to simulate natural lighting.

Water samples (5 ml) were taken at 0,1,2,4,8, and 12 hours and thereafter in 12 hour intervals for a total of 144 hours. Vegetation samples (root and leaf tissue) were collected from water hyacinth that had not been exposed to cadmium and from the plants exposed to 5mg/L cadmium for 144 hours to ascertain net cadmium accumulation. The biomass samples were dried for several days in preparation for analysis.

### 2.1 Analysis of samples

The biomass samples and experimental water samples will be analyzed in atmosphere in a Shimadzu EDX 7000-8000, which will irradiate the sample and detect output energy. The duration of analysis will be 100 seconds per sample.

## 3. Discussion

### 3.1 Anticipated results

As this is an ongoing investigation, the data analysis from this experiment is not readily quantifiable. However, several implications can be made from the extrapolation of data from relevant studies; these implications have informed the present study to a high degree.

### 3.2 Location of accumulation

Soltan and Rashed (2003) found that highest concentrations of heavy metals accumulate in the roots of *E. crassipes* through a spectrum of different heavy metals. In comparison with the root concentrations of *E. crassipes* exposed to different heavy

metals, those exposed to cadmium had the lowest concentrations; contrary to this trend, root concentrations were 5 times greater than the aerial portion within the same plant. Findings of this nature were also noted in another study (Swain et al. 2014). If these findings are an objective characteristic of *E. crassipes*, then under the present study, it can be suggested that the plants will have many times higher cadmium concentration in the root material. These findings also suggest that water hyacinth may have less of an affinity to accumulate cadmium than other heavy metals.

The same comparison of the root and aerial portions of the plant will be completed in the present study to determine primary site of cadmium accumulation.

### 3.3 Cadmium uptake

In regards to the extraction of cadmium from an aquatic medium, many studies have found a strikingly promising result: the uptake of cadmium by *E. crassipes* increases as the concentration of cadmium increases in the roots and external medium (Soltan and Rashed 2003; Lu et al. 2004). Although, this too may have a plateau point as shown by the following graph adapted from another study (Das et al. 2016).

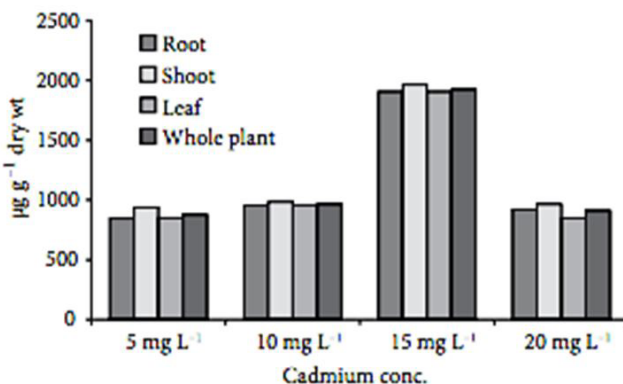

Figure 1. Cadmium concentration in multiple plant sections of *E. crassipes* as starting cadmium concentrations increased (Das et al. 2016).

There is a notable decrease in cadmium extraction when increasing the concentration from 15 ppm cadmium to 20 ppm cadmium; this implies that *E. crassipes* has its peak extraction efficiency at 15 ppm cadmium.

In addition to this behavior, it was also found that cadmium concentration in *E. crassipes* will increase over time (Lu et al. 2004). This can be visualized by the following graph depicting cadmium concentration of the experimental medium as a function of time (Mishra and Tripathi, 2008).

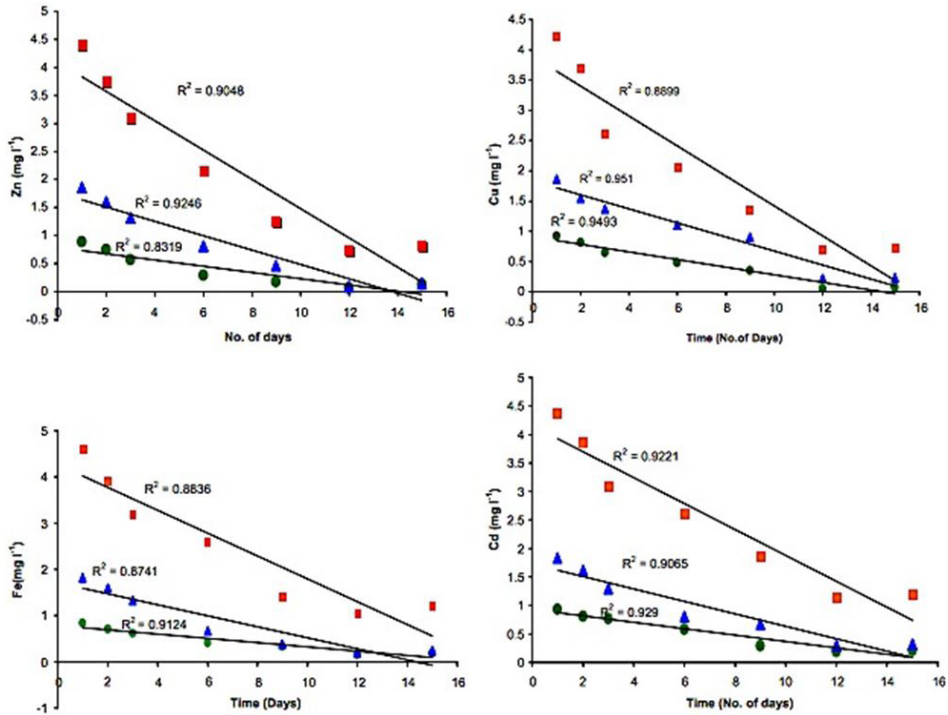

Figure 2. Heavy metal removal from experimental medium by *E. crassipes* at different starting concentrations (Mishra and Tripathi, 2008).

As the above graph shows, as time progresses the amount of cadmium in the surrounding medium decreases; this implies higher quantities are accumulating within the plant. This finding is consistent with other studies.

Each of these findings enforces that expectation that the uptake of cadmium in the present study will increase over time. Additionally, it has been found that this increasing uptake with increasing concentration does not follow a linear trend (Fritioff and Greger, 2007). It can be deduced that this enhancement of uptake will eventually lead to a maximum uptake rate or maximum uptake concentration at which the plateau is likely to

occur. This plateau can be visualized by the following graph adapted from another study (Maine et al. 2001).

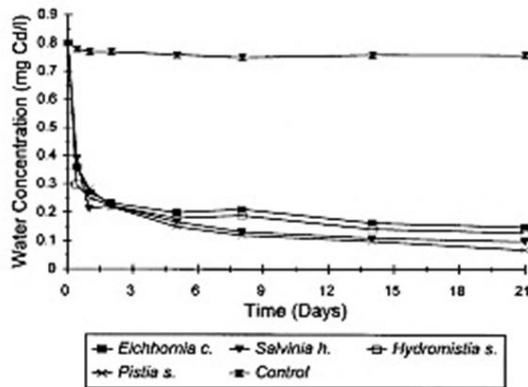

Figure 3. This graph depicts the cadmium concentration in water as time progresses when using several different plants as phytoremediants (Maine et al. 2001).

Although this information is informative, there are several factors distinguishing the present study from the aforementioned that produced the results pictorially represented in the above graph. In the present study, *E. crassipes* was used as the main focus of the experiment, and was exposed to a higher concentration of cadmium (5 mg/L) for 144 hours. This contrasts with the other study in which *E. crassipes* was used primarily as a reference and was exposed to 1 mg/L of cadmium for a longer duration: 21 days.

Despite these differences, the information provided from this study has suggested that the plateau of cadmium extraction will occur within the first 3 days of the experiment when administered using a 1 ppm cadmium external medium concentration. It is possible that the plateau will occur at a similar time at an augmented cadmium concentration. Ideally, the present study will be able to more accurately illuminate when the plateau of extraction occurs in order to optimize total extraction and minimize the rerelease of toxic compounds and other harmful ions (Soltan and Rashed, 2003).

#### 4. Phytoremediation Limitations

Although phytoremediation is a more sustainable alternative to conventional heavy metal remediation techniques, it is not without its limitations: time, contaminant

concentration and location, number of contaminants, biodiversity, and hazardous biomass product (Ghosh and Singh 2005).

#### **4.1 Time**

Unlike conventional methods, when utilizing the technique of phytoremediation to remove contaminants time is a factor of consequence. In fact, depending on several variables, it can take years to fully clean a contaminated site. This is a rather large time investment compared with traditional methods.

The time incurred is likely due to plant acquisition, installation, and growth. Growth is a necessity and a condition that cannot be expedited; it is commonly the mature form of the plant that can accumulate the most heavy metals without succumbing to their toxicity. Therefore, as an example, if a particular species of metallophyte took three years to become an adult then that time commitment is likely the minimum before remediation efforts are in full commencement. However, minimization of this commitment may be possible through the careful selection of plant species.

#### **4.2 Contaminant concentration and location**

Another limitation when using plants for remediation is that they can operate only within a constricted range of contaminant concentrations. Unfortunately, these concentrations tend to be relatively low. Furthermore, the location of the contaminant is important. The majority, if not all, of plants intake contaminants through their root systems and as such the contamination needs to be in an area that the roots can reach. This vertical depth is considered shallow: perhaps 1 meter for larger grasses and a few meters for trees. Unfortunately, this constricts the number of regions that are candidates for phytoremediation. If the contaminants are in the groundwater or several meters underground, then the usage of phytoremediant plants would not be an efficient method of pollutant removal.

#### **4.3 Contaminant number**

The presence of numerous contaminants may negatively impact the ability of plants to extract the target pollutant from the environment. As in the case of heavy metals, the presence of more than one metal (binary and ternary systems) caused antagonistic interactions that led to the decrease in absorption of a few metals in *E. crassipes* (Mahamadi and Nharingo 2010). This information implies that if optimal contaminant extraction is the desired outcome it would be best to use phytoremediation in systems with a singular contaminant. This requirement will prove to be more arduous to fulfill as environmental pollution continues.

#### **4.4 Biodiversity**

As briefly discussed in the introduction, biodiversity is a concern when introducing new plants to an area because they have the potential to become invasive. However, introducing plants into a new area is commonly a requirement for phytoremediation as there is often a lack of indigenous metallophytes. It would be counterproductive to introduce a plant species that collects the contaminants but destroys the preexisting ecosystem. This problem must be carefully considered in order to select the best remediation candidate with the lowest potential for invasive behavior.

#### **4.5 Hazardous biomass product**

One of the most challenging limitations of phytoremediation is the production of hazardous biomass and its difficult disposal. As remediation efforts approach completion, the hazardous biomass accumulates to very large volumes. There are a few theoretical solutions to this problem, such as composting and compaction (Raskin et al. 1997; Hetland et al. 2001), as well as combustion and gasification (Bridgewater et al. 1999). Although these methods solve the dilemma of volume, they do not address the presence of contaminants in the byproducts of these processes—leachate and ash, respectively—as they maintain heavy metal loads. It is clear that the leachate and ash must undergo secondary processing but the exact methods of heavy metal removal have not been thoroughly investigated.

Pyrolysis and phytomining are very promising disposal methods. Pyrolysis is the anaerobic decomposition of hazardous biomass material without emissions that produces a substance called “coke”; the heavy metals are sequestered in the coke, which can be recycled for industrial processes. The degree to which the metals can be recycled has yet to be thoroughly investigated (Ghosh and Singh 2005). Phytomining is the combustion of the biomass for the purpose of creating energy, which introduces an economic benefit, and the subsequent extraction of heavy metals from the bio-ore produced from the process. The heavy metals extracted from the bio-ore will go on to be reused in other processes (Ali et al. 2013). These methods, through energy conversion and material recycling, are the most sustainable thus far but have not been experimentally studied in depth. As such, there are many unknowns about these processes.

### **5. Future Work**

In light of the problem of disposing of hazardous biomass waste generated by phytoremediation, it is likely that future work will be done to find sustainable methods of waste disposal or ways of enhancing current methods. Studies could be done to investigate the efficiency of heavy metal extraction and recycling after the processes of phytomining, pyrolysis, and general combustion. More work may be done to provide



a method of combustion that eradicates all emissions without the generation of heavy metal laden materials.

Another avenue of future work may include methods of enhancing phytoremediation efficiency in the contaminated site. Several methods have been suggested: genetic engineering, induced phytoextraction, increasing bioavailability of heavy metals, chelate-assisted phytoextraction, and decreasing phytoremediation period by accelerating plant growth (Ghosh and Singh 2005; Karami and Shamsuddin 2010). However, these methods are in need of further investigation and elucidation. Work could also be done to evaluate the potential for using bark, lignin, dead biomass, chitin and chitosan as sorbents of heavy metals in place of utilizing live plants (Bailey et al. 1999).

## 6. Conclusion

Heavy metals are hazardous compounds that have found their way into the environment largely through industrial processes; many are toxic, carcinogenic, teratogenic, mutagenic, and environmentally mobile and persistent. Environmental concentrations of these deleterious compounds are increasing in many different environmental compartments. As the presence of these compounds is of ecological and public health concern, it is imperative that sustainable methods of remediation be found and implemented in place of the conventional methods, which are characterized by environmental disruption and degradation. One such promising method may be phytoremediation, utilizing *Eichhornia crassipes* as the phytoremediant. Although the present study is currently ongoing, former studies have yielded results that buttress the underlying principles and anticipated observations of the present study: *E. crassipes* will increase cadmium extraction as cadmium concentrations increase and will accumulate the metal primarily in the roots. Maximum accumulation, and therefore the plateau of cadmium extraction, is suspected to occur within 0-72 hours. At the end of the present study, the plateau of cadmium extraction will be more conspicuous and this will inform remediation decisions when utilizing *E. crassipes*, an invasive macrophyte, as the phytoremediant. This information will allow remediation efforts to be more efficient and timely. Although phytoremediation has environmental benefits, it also has certain limitations and therefore must be considered only for contamination sites where it will be most effective. Future work will enhance efficiency of metal uptake, decrease time commitment, and solve the problem of hazardous metal contamination removal in the harvested phytoremediation biomass.

As scientific endeavors continue to focus on phytoremediation, the questions and limitations surrounding the process will be resolved until it becomes a more commonly used remediation technology.

## Acknowledgements

The contributions and guidance provided by the McNair Scholars Program and Dr. Ashanti Johnson have proven invaluable to the research project. Lab materials provided by Dr. Andrew Hunt and Dr. James Grover were largely utilitarian and quite appreciated. I would like to extend many thanks to all of the aforementioned.

## References

- Ali H, Khan E, Sajad MA. 2013. Phytoremediation of heavy metals—concepts and applications. *Chemosphere*. 91(7):869-81.
- American Public Health Association. 1994. Water environment federation (1998) standard methods for the examination of water and wastewater.
- Awofolu OR. 2005. A survey of trace metals in vegetation, soil and lower animal along some selected major roads in metropolitan city of Lagos. *Environ Monit Assess*. 105 (1-3):431-47.
- Bailey SE, Olin TJ, Bricka RM, Adrian DD. 1999. A review of potentially low-cost sorbents for heavy metals. *Water Res*. 33(11):2469-79.
- Bridgwater AV, Meier D, Radlein D. 1999. An overview of fast pyrolysis of biomass. *Org Geochem*. 30(12):1479-93.
- CDC - Immediately Dangerous to Life or Health Concentrations (IDLH): Cadmium compounds (as Cd) - NIOSH Publications and Products [Internet]; 2014. Available from: <http://www.cdc.gov/niosh/idlh/7440439.html>
- Das S, Goswami S, Talukdar AD. 2016. Physiological responses of water hyacinth, *Eichhornia crassipes* (Mart.) Solms, to cadmium and its phytoremediation potential. *Turkish Journal of Biology*. 40(1):84-94.
- Degraeve N. 1981. Carcinogenic, teratogenic and mutagenic effects of cadmium. *Mutation Research/Reviews in Genetic Toxicology*. 86(1):115-35.
- Fritioff S, Greger M. 2007. Fate of cadmium in *Elodea canadensis*. *Chemosphere*. 67(2):365-75.
- Ghosh M, Singh SP. 2005. A review on phytoremediation of heavy metals and utilization of its byproducts. *Asian J Energy Environ*. 6(4):18.
- Govindasamy C, Arulpriya M, Ruban P, Jenifer LF, Ilayaraja A. 2011. Concentration of heavy metals in seagrasses tissue of the Palk Strait, Bay of Bengal. *Int J of Environ Sci*. 2(1):145-53.
- Hetland MD, Gallagher JR, Daly DJ, Hassett DJ, Heebink LV. 2001. Processing of plants used to phytoremediate lead-contaminated sites. Sixth international in situ and on site bioremediation symposium. 129 pp.
- Jafari N. 2010. Ecological and socio-economic utilization of water hyacinth (*Eichhornia crassipes* Mart Solms). *Journal of Applied Sciences and Environmental Management*. 14(2).

- Karami A, Shamsuddin ZH. 2010. Phytoremediation of heavy metals with several efficiency enhancer methods. *African J of Biotech.* 9(25):3689-98.
- Lu X, Kruatrachue M, Pokethitiyook P, Homyok K. 2004. Removal of cadmium and zinc by water hyacinth, *eichhornia crassipes*. *Science Asia.* 30(93):103.
- Mahamadi C, Nharingo T. 2010. Competitive adsorption of pb 2, cd 2 and zn 2 ions onto *eichhornia crassipes* in binary and ternary systems. *Bioresour Technol.* 101(3):859-64.
- Maine MA, Duarte MV, Suñé NL. 2001. Cadmium uptake by floating macrophytes. *Water Res.* 35(11):2629-34.
- Miretzky P, Saralegui A, Cirelli AF. 2006. Simultaneous heavy metal removal mechanism by dead macrophytes. *Chemosphere.* 62(2):247-54.
- Mishra VK, Tripathi BD. 2008. Concurrent removal and accumulation of heavy metals by the three aquatic macrophytes. *Bioresour Technol.* 99(15):7091-7.
- Mulligan CN, Yong RN, Gibbs BF. 2001. An evaluation of technologies for the heavy metal remediation of dredged sediments. *J Hazard Mater.* 85(1):145-63.
- Petit CM, Ringoet A, Myttenaere C. 1978. Stimulation of cadmium uptake in relation to the cadmium content of plants. *Plant Physiol.* 62(4):554-7.
- Pulford ID, Watson C. 2003. Phytoremediation of heavy metal-contaminated land by trees—a review. *Environ Int.* 29(4):529-40.
- Rai UN, Tripathi RD, Vajpayee P, Jha V, Ali MB. 2002. Bioaccumulation of toxic metals (cr, cd, pb and cu) by seeds of *euryale ferox salisb.* (makhana). *Chemosphere.* 46(2):267-72.
- Raskin I, Smith RD, Salt DE. 1997. Phytoremediation of metals: Using plants to remove pollutants from the environment. *Curr Opin Biotechnol.* 8(2):221-6.
- Salem HM, Eweide A E, Farag A. 2000. Heavy metals in drinking water & their environment impact on human health. *ICEHM2000*, Cairo University, Egypt, September, 2000, page 542- 556.
- Schutzendubel A, Polle A. 2002. Plant responses to abiotic stresses: Heavy metal-induced oxidative stress and protection by mycorrhization. *J Exp Bot.* 53(372):1351-65.
- Soltan ME, Rashed MN. 2003. Laboratory study on the survival of water hyacinth under several conditions of heavy metal concentrations. *Adv Environ Res.* 7(2):321-34.
- Swain G, Adhikari S, Mohanty P. 2014. Phytoremediation of copper and cadmium from water using water hyacinth, *eichhornia crassipes*. *Int J Agr Sci Tech.* 2(1):1-7.
- Tchounwou P, Yedjou C, Patlolla A, Sutton D. 2012. Heavy metal toxicity and the environment. In: *Molecular, clinical and environmental toxicology*. Basel: Springer Basel. 133 pp.
- Tiwari S, Dixit S, Verma N. 2007. An effective means of biofiltration of heavy metal contaminated water bodies using aquatic weed *eichhornia crassipes*. *Environ Monit Assess.* 129(1-3):253-6.

# Abstracts

## The Antibacterial Activity of Organotins and Organometallics

**Jaclyn Bazaldua**

Biology and Microbiology

Mentor: Dr. Michael Roner,  
Department of Biology



The latest significant antibiotic was developed three decades ago. Novel research fields have begun to combat bacterial antibiotic resistance by looking for antibiotics that are from unfamiliar fields. Eleven synthetic compounds were tested to combat the lack of antibiotics: two organotins (chelidonic acid and salicylic acid), two salicylic organotin polymers, and seven poly(ethylene glycols) titanocene organometallic polymers. Organotins and organometallics have been proven to cause zones of inhibition, but the reasons are unclear. By using a broth microdilution assay along with a disk diffusion assay, the compounds were tested against ten different bacteria, eight of which were gram-negative. The assays were tested with a number of different concentrations per compound, giving more in-depth results. The highest inhibition of bacteria during the microdilution assay was the salicylic organotin compound at a concentration of 1 mg/ml, while the remaining compounds inhibited the most growth at 0.01 mg/ml. In the disk diffusion assay the largest zone of inhibition achieved was 0.1 cm by an organometallic polymer, while some bacteria were unaffected by the compounds altogether.

## Essential Indexicality and Self-Consciousness

**Tristen Cardwell**

English and Philosophy

Mentor: Dr. Kenneth Williford,  
Department of Philosophy and  
Humanities



The problem of the essential indexical and that of irreducibly *de se* attitudes are considered key issues for the understanding of what it means to speak about and think about oneself. The main claim argued for within the Perry-Lewis tradition is that the kinds of beliefs and sentences required for knowingly speaking of and thinking about oneself necessarily contain indexical elements. If any beliefs or sentences involving definite descriptions or non-indexical singular terms that refer to oneself are to be known to convey information about oneself, they must ultimately link up with the kinds of propositions that involve some sort of essentially indexical or irreducibly *de se* content. Although this idea has been widely accepted in many areas of philosophy and in linguistics, it has of late been challenged as a mere intuition with no supporting evidence. I respond by defending essential indexicality indirectly, mounting arguments extrapolated from two bodies of work associated with the Perry-Lewis tradition: Stephen Wechsler's semantics of first- and second-person pronouns and James Higginbotham's semantics of certain PRO constructions. I will show that these approaches to essential indexicality can be grounded in an independently motivated self-representational theory of consciousness.

## The Price of a Pill: Price Disparities of Common Diabetic Medications

**Claudia Carranza**

International Business and Spanish

Mentor: Dr. Jeffery McGee,  
Department of Management



The incidence of diabetes in the United States is growing at an alarming rate. Moreover, the cost of treating this disease is increasing 60 times faster than recent income growth. This research attempts to address one of the contributors to the high cost of diabetes treatment by examining the price differences between brand name oral medications and their generic equivalents. Specifically, I collected pricing data on prescribed diabetes oral medications, over the counter non-diabetes oral medications, and prescribed non-diabetes oral medications. Using this data, I ran a series of student t-tests and an ANOVA test. The results clearly suggest that generic drugs are significantly less expensive than their brand name counterparts even though the active ingredients are identical. The results lead to a discussion of how patents, marketing, potency, and service can affect the final cost of brand name oral medications making them more expensive than their generic equivalents. Limitations, such as a limited number of prescribed diabetes oral medication samples, are also presented. The research concludes with the notion that the FDA should consider reforms to facilitate the restrictions pharmaceutical companies face when trying to create a generic oral medication that is equivalent to the brand name.

## The Relationship between Temperament, Externalizing Behaviors, and Family Factors in Young Children

**Sydney Cox**

Psychology

Mentor: Dr. Jeffrey R. Gagne,  
Department of Psychology



The current study was designed to examine young child negative affect and difficult temperament behaviors and maternal negative personality traits and mental health symptoms as predictors for these behavior problems. Mothers completed surveys that assessed child temperament and behavior problems, and the mother's personality traits and mental health symptoms. We hypothesized that children who display high levels of negative affect behaviors (e.g., poor impulse control [IC] and anger) are more likely to have higher levels of externalizing behavior problems such as aggression. We also predicted that negative caregiver personality traits and mental health symptoms will be associated with the child variables studied. Bivariate correlations and regression analyses were calculated on the data. Results showed that children who had negative affect behaviors such as anger and IC were more likely to have behavior problems (e.g., aggression or oppositional defiant disorder [ODD]). Maternal negative personality traits and mental health symptoms were also shown to have a negative influence on child behavior. Hierarchical regression analyses were calculated to account for child gender and demonstrated that maternal trait anxiety predicted child ODD behavior problems and maternal neuroticism predicted child aggressive behavior problems. The implications of associations among child negative affect, temperament, and behavior problems and maternal personality traits and mental health symptoms are discussed.



## F<sub>420</sub> H<sub>2</sub>:NADP<sup>+</sup> Oxidoreductase Hydride Transfer Rates: Kinetic Analysis of Thr09 Mutant

**Katie Kang**

Microbiology

Mentor: Dr. Kayunta Johnson-Winters,  
Department of Chemistry and  
Biochemistry



F<sub>420</sub> cofactor is an NADP analog whose structure is reminiscent of 5-deazaflavin that is found in methanogenic and sulfate-reducing archaea. Because of its high abundance in cells, F<sub>420</sub> cofactor is believed to be the major electron transfer entity. F<sub>420</sub> exclusively mediates two-electron transfer reactions and has a low redox potential, which is required for specific energy producing reactions such as the conversion of carbon dioxide to methane. While there are many F<sub>420</sub> dependent archaean enzymes, our focus is on F<sub>420</sub> H<sub>2</sub>:NADP<sup>+</sup> Oxidoreductase (Fno). Fno catalyzes the production of reduced NADP, an important biological fuel. Thr 09, a conserved amino acid within Fno that interacts with NADP, was converted into T09A in order to study the effects of the hydroxyl group on hydride transfers. The binding studies displayed a 5-fold increase in the NADPH dissociation constant. According to the steady-state data, the presence of NADPH is required prior to FO for optimal activity for the T09A variant. The presteady-state kinetic data revealed a 36-fold increased rate of hydride transfer for the T09A variant compared to wtFno. In contrast to wtFno presteady-state kinetic data, T09A displayed a single-phase exponential decay, rather than biphasic burst kinetics, as seen with wtFno. These data suggest that Thr 09 plays a role in NADPH binding, as well as the rate at which the hydride is transferred to the FO cofactor and subunit communication within the Fno dimer.

## Content Analysis of Foreign Policy Speeches: Critical Issues Based on North Korea

**Minwoo Kim**

Political Science and Journalism

Mentor: Dr. Herschel F. Thomas,  
Department of Political Science



In East Asia, issues involving North Korea are of strategic and economic importance. The countries of Japan, South Korea, China, and the United States routinely mention problems related to North Korea on human rights, nuclear warfare, territorial issues, and trade. However, these countries all have separate rhetoric on these problems. Part one of my research analyzes rhetoric of the foreign ministers of each country. I compiled 2,413 speeches from the US secretary of state and the foreign ministers of Japan, South Korea, and China according to content. Across the four issues, as expected, China has the least amount of rhetoric on human rights and the most on trade. The rhetoric by South Korea, Japan, and China on all four topics are mentioned equally. In part two, after analyzing the data on all four problems, I correlate the four problems with North Korea. Any rhetoric that mentions both the problems and North Korea is discussed in part two. Analysis of these speeches shows that China has the least amount of rhetoric on human rights and North Korea. South Korea, Japan, and the United States equally mention all four problems and North Korea. Analysis shows that of the four problems, nuclear warfare is the most mentioned problem correlated to North Korea.

## Characterization of Early Damage in Airframe Structures Using Embedded Magnetostrictive Particles

**Nicolas E. Long**

Mechanical Engineering

Mentor: Dr. Andrew V. Makeev,  
Department of Mechanical and  
Aerospace Engineering

Army Research Lab Mentors: Michael D. Coatney, Dr. Mulugeta  
A. Haile

Supporting Role: Dr. Asha J. Hall, Dr. Jin Hyeong Yoo



Early stage material damage in critical airframe structures is not detectable with existing sensing techniques, such as the ultrasonic pitch-catch or pulse-echo. These methods are only reliable for detection of macroscopic damage, such as large cracks or delamination, and as such by the time macroscopic damage is detected most of the structural life may have been expended, resulting in a high-risk platform operation and/or unplanned downtime. An experimental study was conducted to investigate the viability of embedded magnetostrictive particles for detection of early stage structural damage in composite materials. Test specimens were fabricated from thirteen unidirectional plies of a pre-preg carbon/epoxy material system with Terfenol-D particles evenly spread in mid layer. The specimens were then subjected to cyclic fatigue loading while monitoring the change in the magnetic flux density using an induction coil. Acoustic emissions were captured simultaneously using two wide-band sensors mounted within the gage length of the specimen. Preliminary test results show that the embedded system exhibits a change in magnetic flux strength starting from the first few fatigue load cycles.

## Attitudes and Uses of the Spanish Language in the Dallas-Fort Worth Metroplex

**Claudia Martinez**

Spanish

Mentor: Dr. Sonia Kania, Department of Modern Languages



In this study, 100 Hispanics in the Dallas–Fort Worth Metroplex area were surveyed with the purpose of analyzing if the Spanish language is being lost in the third generation of speakers as the three-generation shift model suggests. The attitudes of Hispanics towards their native heritage language were examined. The data obtained suggests that Hispanics hold positive attitudes towards Spanish and desire that future generations learn to speak Spanish fluently. The uses of Spanish by Hispanics were reviewed according to their respective generation. It was found that the uses of Spanish decline drastically in the second generation in favor of English, which is faster than expected. This suggests that if Spanish is rapidly being displaced by English in the second generation, only immigrants of the first generation maintain their native language in the United States. Thus, if Hispanics desire to preserve the Spanish language, the language should be transmitted from one generation to the next, and Spanish should be used in contexts outside the home. Additionally, formal instruction in Spanish would support the maintenance of the language.

## Silane Dimerization Enabled by Ruthenium Catalysts

**Jessica McCammon**

Chemistry

Mentor: Dr. Junha Jeon, Department of Chemistry and Biochemistry



Silicon chemistry is on the cutting edge of research across a variety of industries. The virtually nontoxic compound is furthering organic chemistry by providing new pathways to reduce steps for syntheses. Our laboratory has been involving research on synthesis of organosilicon molecules by employing ruthenium complex catalysts, the discovery of which won for Robert Grubbs a share of the 2005 Nobel Prize in chemistry. The ruthenium complexes were discovered as catalyzing dimerization of the silanes present in these reactions. Our laboratory became interested in the application of silane dimerization when the byproduct disilanes were observed. By themselves disilanes have value in technology and other industries, but in our laboratory we employed them to simultaneously form two carbon-silicon bonds across unsaturated carbons, which can lead to more efficient synthesis for life-saving drugs and agrichemicals. Knowing that silane coupling was occurring via ruthenium catalysts, we began research to decipher which of the catalysts were most effective for silane coupling reactions. The work is in progress still, but so far each catalyst has been effective for the reaction to varying degrees with 1,1,1,3,5,5,5-heptamethyltrisiloxane as the monosilane. We expect we will find, with further work, that disilanes can be formed in high yields from certain combinations of substituted silanes with one or more of these catalysts.

## Will the Real Amadeus Please Stand Up: A Historic Reappraisal of Peter Shaffer's *Amadeus* and the *Memoirs of Lorenzo Da Ponte*

**Kayleigh Miranda**

Music Education

Mentor: Dr. Graham Hunt, Department  
of Music



The historical accuracy of Peter Shaffer's *Amadeus* has been the catalyst for much controversy, ridicule, and curiosity for both scholars and the average Mozart enthusiast. Despite the copious amounts of research that Shaffer and director Milos Forman did in preparation for the film, it was intended to be a drama and not a biography. Thus, many artistic liberties were taken in the making of the movie. Throughout *Amadeus*, some of the most intriguing scenes are based on the experiences of real people not depicted in the film. This paper addresses the memoirs of Lorenzo Da Ponte, an active librettist in Vienna, from which some of these scenes originated. Although his memoirs became part of the film, Da Ponte himself was not so fortunate. Many people and situations from Da Ponte's memoirs became a part of Shaffer's characters. Indeed, Da Ponte's many professional and personal rivalries were altered to suit the drama, the storyline, and the available characters. Rather than being criticized for the inaccuracies of the film and storyline, however, Shaffer should be praised for his dedicated, albeit now outdated, research and careful portrayal of a man whom he describes as "one of the few people in history whose achievement justifies human evolution."