

PERFORMANCE EVALUATION OF A COMPLIANT FOIL SEAL

By

SASHIDHAR RAGHURAMAN

Presented to the Faculty of the Graduate School Of
The University of Texas at Arlington in Partial Fulfillment
of the Requirements
for the Degree of

MASTER OF SCIENCE IN MECHANICAL ENGINEERING

THE UNIVERSITY OF TEXAS AT ARLINGTON

MAY 2015

Copyright © by Sashidhar Raghuraman 2015

All Rights Reserved



Acknowledgements

I sincerely thank my supervising professor, Dr. Daejong Kim for his guidance and unwavering support throughout the course of research. I would also like to thank my committee members Dr. Kent Lawrence and Dr. Ratan Kumar.

I would like to mention special thanks to my mentor, Dr. Fengchang Xu, for patiently supporting and directing me towards the accomplishment of the project goal. I would also like to thank my colleagues and friends in Micro turbo machinery and Energy Systems Lab for their help and support.

I would like to express my gratitude to Mr. Kermit Beird from machine shop for extending support at each stage in fabrication and assembly of test setup. I would also like to acknowledge the financial support provided by Dr. Kim. And most importantly, I would thank my family and friends for their love and support throughout the master's degree.

April 29 2015

Abstract

PERFORMANCE EVALUATION OF A COMPLIANT FOIL SEAL

Sashidhar Raghuraman, M.S.

The University of Texas at Arlington, 2015

Supervising Professor: Daejong Kim

The concept of foil bearings has gained large acceptance in the industry and is been applied for various rotating equipment including air cycle machines, cryogenic turbo-expanders, centrifugal compressors and gas turbine engines. The ever-increasing demand for maintenance free and durable components has led to the development of compliant foil seals (CFS). Labyrinth and Brush seals have been widely employed for reducing the leakage flow at high pressure and temperature conditions, to enhance the overall performance of the system. Increase in the radial clearance to compensate the lack of their capability to accommodate the higher rotor orbits results in more leakage. By overcoming these limitations, the foil seal has immensely drawn the attention. Methods are being researched to make CFS much more reliable and durable for wide applications.

The operating principle of this non-contacting foil seal is based on the foil bearing technology. Using air as the fluid, the foil seal builds hydrodynamic pressure, which not only solves the purpose of sealing the leakage, also exhibits the bearing properties.

This work presents the design, fabrication and assembly of a foil seal, its investigation at various conditions and solution to few dynamics problems faced during experimentation. A previously constructed test rig was utilized to test the newly fabricated foil seal. Prior to the preliminary test, the radial clearance value of the foil seal was

obtained using a push-pull mechanism. Two ball bearings were used in the test rig to ensure reduced damping for accuracy in evaluation of foil seal. The rotor displacements were measured before testing the foil seal. Preliminary tests indicated issues including higher friction during deceleration and no sealing action. The seal was redesigned and fabricated in Single pad and Three-pad configurations to resolve these issues. The sealing capacity was recorded at rotor speeds and the differential pressure achieved across the seal was noted. Simultaneously, the frictional force values were also monitored. The inclusion of three-pad design was done to evaluate the performance for a continuous and stable operation, which was restricted in one pad foil seal. The test results for all the configurations are discussed and improvement in current fabrication methods are being proposed.

Table of Contents

Acknowledgements	iii
Abstract	iv
List of Illustrations	viii
List of Tables	x
Chapter 1 Introduction.....	1
1.1 Sealing operation & its characteristics	2
Chapter 2 Literature review.....	4
Chapter 3 Research objective.....	13
Chapter 4 Experimental setup	15
4.1 Test rig configuration	15
4.1.1 Foil seal	15
4.1.1.1 Seal cavity.....	16
4.1.1.2 Seal housing	18
4.1.1.3 Bump foils	18
4.1.1.4 Top foils.....	19
4.1.2 Foil seal assembly.....	21
4.1.2.1 Basic configuration.....	21
4.1.2.2 One pad foil seal	22
4.1.2.3 Three pad foil seal	23
4.1.3 Measuring instruments	26
4.1.3.a Pressure transducer.....	26
4.1.3.b Torque monitoring.....	27
4.1.3.c Flow meter.....	27
4.1.4 Loading mechanism	28

Chapter 5 Results & Discussion	29
5.1 Radial clearance test	29
5.2 Seal characteristics	30
Chapter 6 Future scope & Conclusion	38
Appendix A Post test inspection of foil seal	39
Bibliography	41
Biographical Information	44

List of Illustrations

Figure 1-1 Seal application in gas compressor.....	1
Figure 1-2 Schematic of a Compliant foil seal	3
Figure 2-1 Test rig setup for high temperature of foil seal	4
Figure 2-2 Investigation of 2.5 inch CFS.....	5
Figure 2-3 Schematic of Miti foil seal	6
Figure 2-4 Seal housing	7
Figure 2-5 Test section for 6-inch foil seal.....	8
Figure 2-6 8.5-inch CFS tested at NASA	9
Figure 2-7 Wear of top foil.....	9
Figure 2-8 Anchored top foil facing high pressure zone	10
Figure 2-9 Test rig configuration with two ball bearings and identical seals.....	11
Figure 3-1 Schematic of basic configuration tested in this study	13
Figure 4-1 Sectional view of foil seal assembly	16
Figure 4-2 Seal cavity	17
Figure 4-3 Seal housing	18
Figure 4-4 Bump foils welded onto housing	21
Figure 4-5 One pad foil seal	23
Figure 4-6 Three pad foil seal	23
Figure 4-7 Foil seal assembly	25
Figure 4-8 Pressure transducer plugged into seal cavity	26
Figure 4-9 Test rig setup with instrumentation	27
Figure 5-1 Setup to measure radial clearance	29
Figure 5-2 Basic configuration	30

Figure 5-3 One pad foil seal.....	31
Figure 5-4 Differential plot over time.....	32
Figure 5-5 Differential plot over time, One pad foil seal 35 microns.....	33
Figure 5-6 Differential plot over time, Three pad foil seal 35 microns	34
Figure 5-7 Leakage flow vs Rotor speed, One pad foil seal.....	35
Figure 5-8 Pressure vs Rotor speed, One pad foil seal.....	35
Figure 5-9 Leakage flow vs Rotor speed, Three pad foil seal	36
Figure 5-10 Pressure vs Rotor speed, Three pad foil seal	36
Figure 5-11 Flow factor comparison	37

List of Tables

Table 4-1 Foil seal specification.....	17
Table 4-2 Bump foils fabrication procedure	19
Table 4-3 Top foil fabrication procedure	20
Table 4-4 One pad foil seal assembly procedure	22
Table 4-5 Three pad foil seal assembly procedure.....	24
Table 5-1 Basic configuration	30
Table 5-2 One pad foil seal, 60 microns	31
Table 5-3 One pad foil seal, 35 microns	33
Table 5-4 Three pad foil seal, 35 microns.....	34

Chapter 1

Introduction

Foil bearing technology has significantly progressed in the industry in terms of reliability, durability and performance. They have been successfully used in many rotating equipment viz., Air cycle machines, centrifugal compressors, micro gas turbines and cryogenic turbo expanders. They have gained this remarkable demand due to simplicity in their geometry, minimum maintenance and also with consistent research by many in the industry to improve the bearing characteristics.

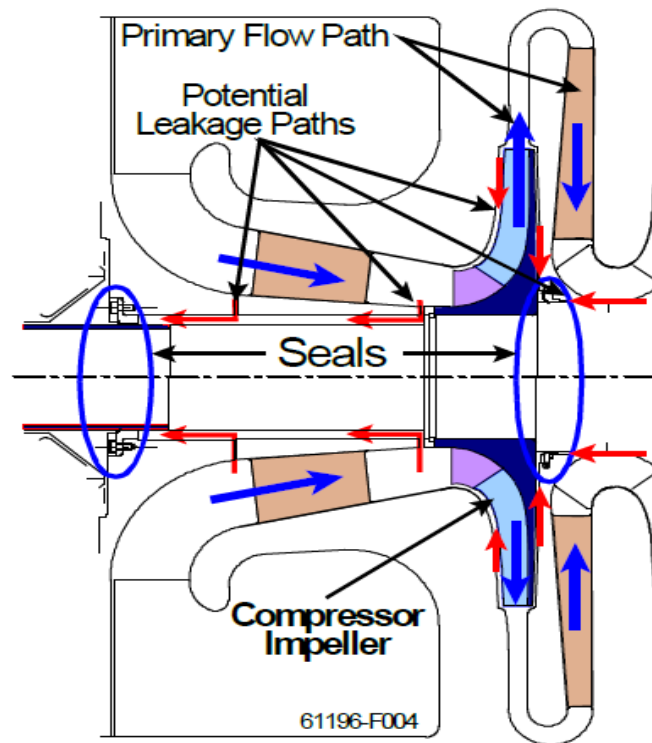

Figure 1-1 Seal application in gas compressor, adopted from Ref [13]

Compliant foil seals (CFS), which were introduced based on the concept of Foil bearing, are also currently gaining market attention, with its novel feature of sealing action without maintaining any contact with the journal surface. These seals are used in reducing the leakage and hence enhancing the performance of gas turbine engines at high pressure & temperature conditions.

They are gradually replacing the conventionally used labyrinth (also known as labby seals) and brush seals by overcoming their limitations. The main problem faced with these seals is their lack of accommodation for rotor excursions. Hence the larger clearance designed to compensate them result in leakage. The performance of the labby and brush seals is discussed in detail in [8].

CFS comprises of a set of top foils supported by a corrugated bump foil structure mounted on a seal holder and structure. The circular top foil sheet acts as the sealing surface, the clearance between this sheet and the journal serves as the region where the hydrodynamic pressure is generated, similar to radial gas foil bearings. The corrugated bump foil structure provides the dynamic support (damping) tolerating the increased rotor orbits and misalignment. The foil structure is made out of heat treated Inconel, a nickel-chromium based alloy. The bump foils are welded to the seal sleeve but unlike the foil bearings the top foils have a curvature with slotted extensions, which are clamped to the housing.

1.1 Sealing operation & its characteristics

At rotation, the small operating clearance between the journal and the foil surface, using air as the fluid, does self-acting hydrodynamic action and thus the thin air film levitates the shaft resulting in a non-contact operation. The film thickness is normally in the range of 15-100 micrometers. The hydrodynamic pressure built acts as a wall separating the high pressure & low-pressure regions, thus preventing the leakage flow.

The flow in a foil seal is a combination of the shear flow in the direction of rotation (Couette flow) and axial flow (Poiseuille flow). These flows are dominant based on the differential pressure and hydrodynamic pressure that is created across the seal.

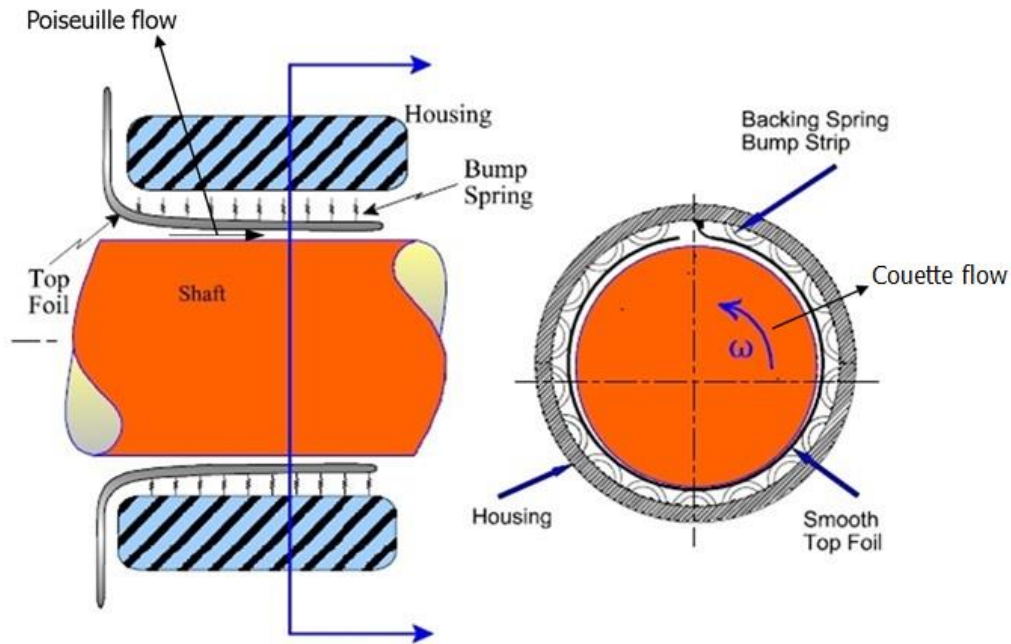

Figure 1-2 Schematic of a Compliant foil seal, adopted from Ref [13]

Besides serving the primary function of preventing the leakage, the seal also acts serves as a load carrying bearing, being similar in design to a foil bearing, with the stiffness & damping characteristics provided by the compliant foil structure.

Although a vibration controlled operation without any rubbing is achievable with a leakage reducing foil seal, maintaining such a low radial clearance becomes difficult in actual conditions. Simple in its design, the foil seal geometry requires high precision & accuracy in fabrication & assembly. Minor variations drastically affect its performance.

Chapter 2

Literature review

Heshmat et al [2] tested the performance of a compliant foil seal in a Turbine hot section along with CFB and a ball bearing in the cold section of the rig. They followed the coast down procedure where they reduced from max speed to zero to record the maximum rotor displacement. They performed leakage tests at two temperatures: 25 C and 595 C concluding that the leakage at the room temperature is less than that of higher temp. Also due to reduction of elastic modulus at higher temp, stiffness and damping properties also decrease.

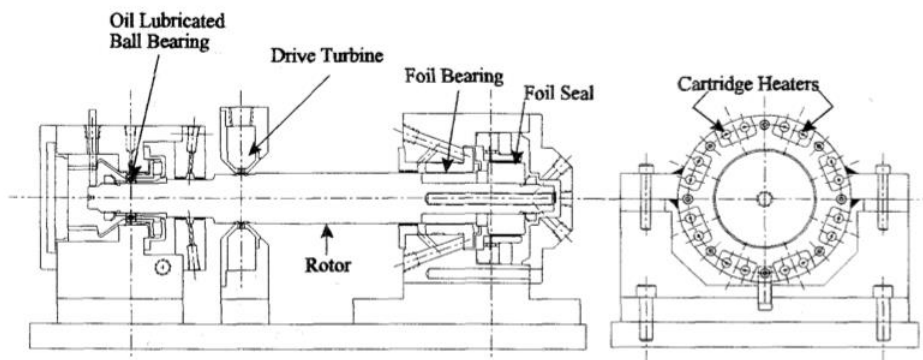

Figure 2-1 Test setup for High temperature evaluation of Foil seal, adopted from Ref [2]

They increased the rotor speed at a constant differential pressure to check the leakage flow. Results demonstrated minimal effect on the leakage characteristics of the foil seal although there was increase in hydrodynamic pressure.

Jahanmir et al [4] evaluated the performance of oil free bearings and seals for various configurations under different inlet pressure, radial clearance and rotor speed

conditions. They simulated for Air & Helium (For Hydrogen) under ambient and high temperature conditions.

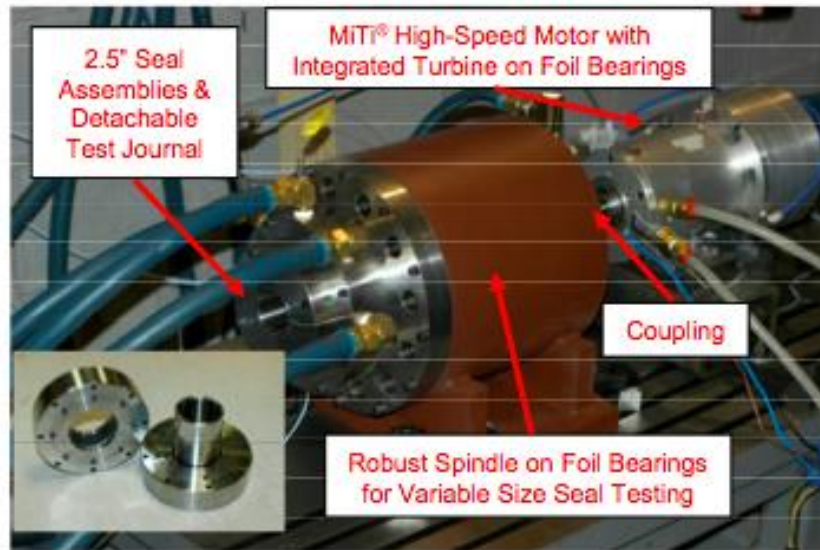

Figure 2-2 Investigation of 2.5 Inch CFS, adopted from Ref [4]

To characterize seal leakage as a function of inlet pressure and speed, setup was instrumented to measure inlet mass flow, pressure and rotor orbits. Out of all configurations they tested, the most significant contribution on the seal performance was from the lowest radial clearance; lesser the clearance lesser was the leakage flow. They also concluded that seal leakage increased with inlet pressure. Computational results were compared with experimental values for mass flow leakage. They also used face bumps with the objective of reducing the leakage further.

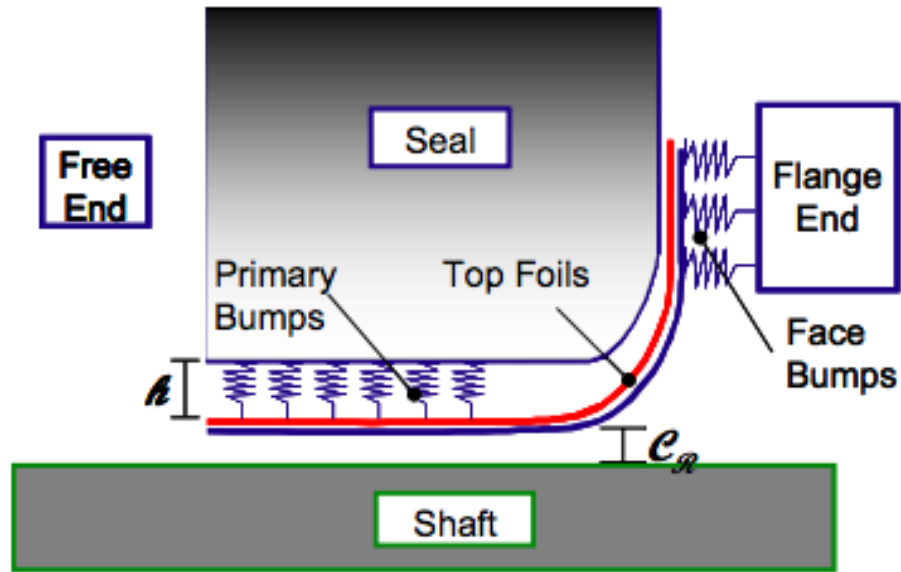

Figure 2-3 Schematic of Miti Foil Seal, adopted from Ref [4]

Salehi et al at Mohawk Innovative Technology, Inc.(Miti) studied the turbulent effects in a compliant foil seal [3] and derived an equation for leakage flow after accounting for the turbulent effects in the pressure distribution equation. G_x and G_z , that is included in the above Reynolds equation used for solving the pressure & film thickness for fluid film lubrication, are the turbulence functions derived based on the local Reynolds number and the characteristics of the flow.

$$\frac{\partial}{\partial x} \left(G_x \frac{\rho h^3}{\mu} \frac{\partial p}{\partial x} \right) + \frac{\partial}{\partial z} \left(G_z \frac{\rho h^3}{\mu} \frac{\partial p}{\partial z} \right) = 6U \frac{\partial(\rho h)}{\partial x} \dots\dots\dots (2.1)$$

Once the pressure field was obtained, they used the same equation as the hydrodynamic bearings to calculate the leakage flow,

$$q_s = \int_0^{2\pi} \frac{h^3}{12\mu} \left(\frac{dp}{dz} \right) R d\theta \dots\dots\dots (2.2)$$

Salehi and Heshmat [7] also tested the performance of a large compliant foil seal in a Turbine hot section. The maximum pressure obtained in the CFS (2.84inch) used in [1] was 40psi and hence the hardware was modified to attain increase in differential pressure across the CFS. The modification included increased end geometry of the housing, additional foils, matching the curvature of top foils with housing. Flow distributor ring was installed to direct the flow to CFS and metallic seals were used between the mating parts.

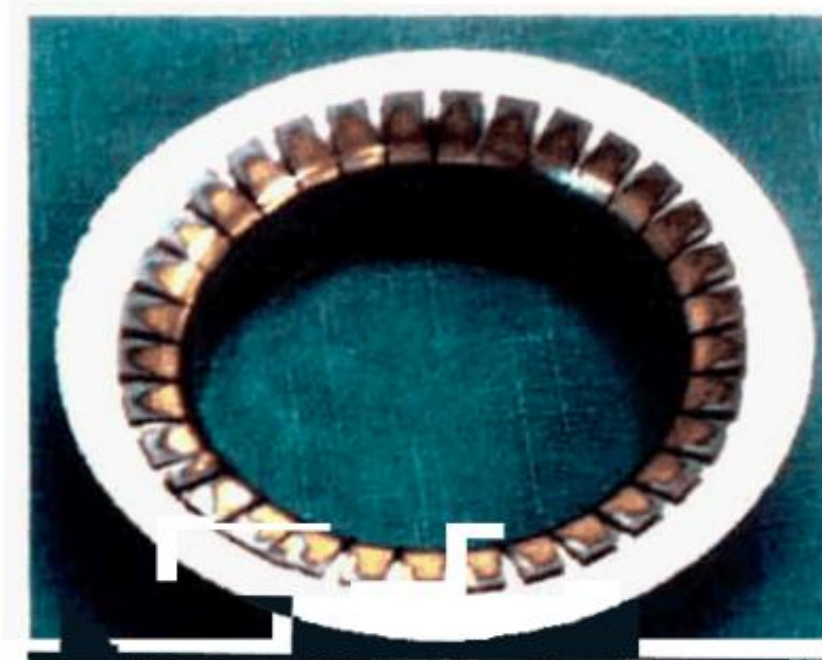

Figure 2-4 Seal housing

They also tested a 6-inch foil seal and compared with the smaller one. Testing at different RPMs resulted in same conclusion as [1], but better leakage flow characteristics was obtained. Increased differential pressure as desired was also possible using this design.

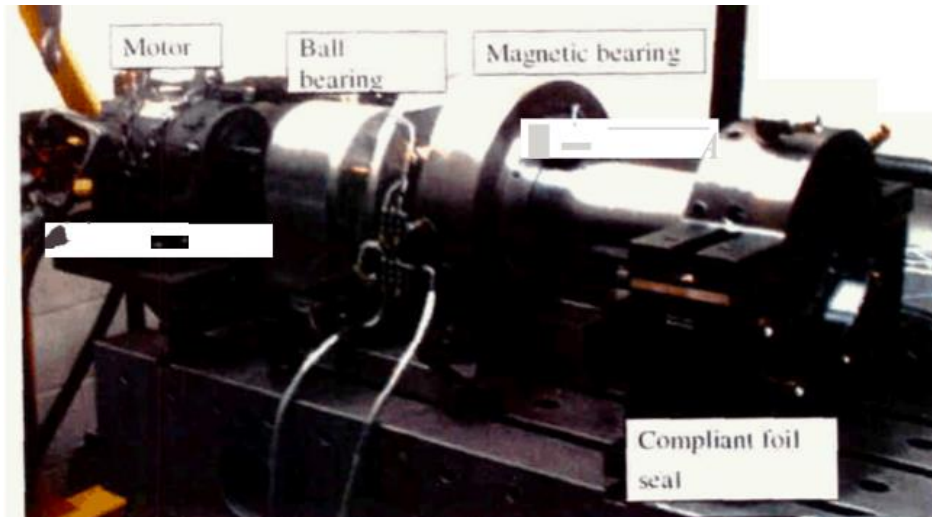

Figure 2-5 Test section for 6-inch foil seal

In the first region (0-40psi), the seal flow increased linearly with the differential pressure at a higher rate compared to the second region where the seal flow had lower variation with the differential pressure. Also supporting [1], the rotor speed had minimal effect on the leakage flow. It was concluded that it was a strong function of differential pressure.

Margaret P. Proctor and Irebert Delgado at the NASA Glenn Research Center investigated the performance of an 8.5-inch compliant foil seal. The seal was operated at speeds up to 30,000 rpm and pressure differentials up to 75 psid. Seal leakage and power loss data were presented and compared to brush seal performance.

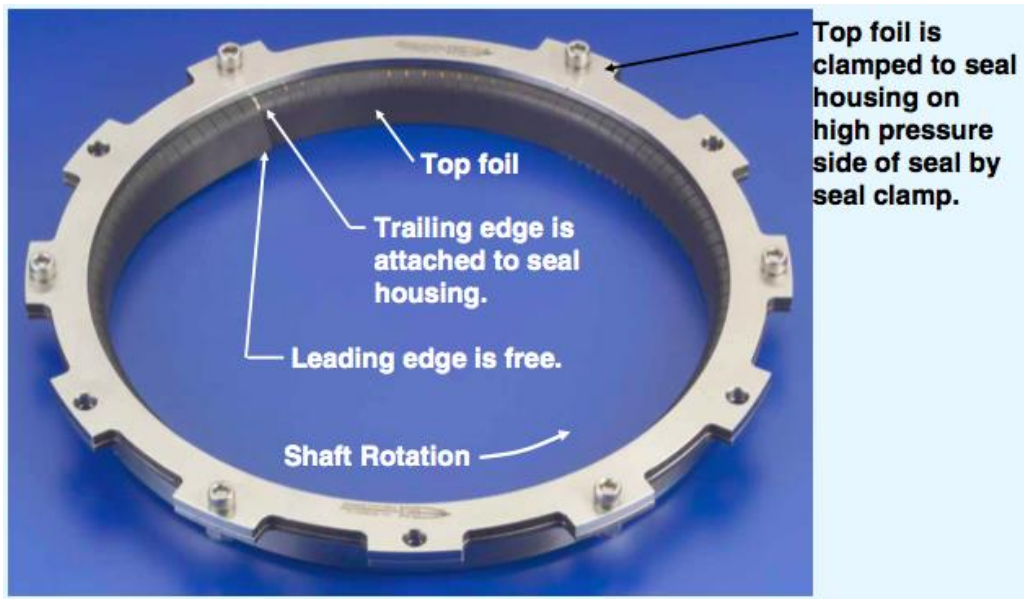

Figure 2-6 8.5-Inch CFS tested at NASA, adopted from Ref [5]

The leakage characteristics observed until 25000rpm were similar to the ones discussed previously. The unusual behavior found was at 30krpm and 15psid.



Figure 2-7 Wear of top foil at 30krpm, adopted from Ref [5]

The rotor orbits became large and worsened, as the rotor was decelerated. Posttest inspection showed the damage of coating & wear of top foil. This affected the

leakage performance of the foil seal. It was concluded that the leakage data for 3-inch CFS previously tested was better than that of the large seal and also in comparison with the brush seals, the cause of problem faced with the large CFS was not addressed.

Aksoy et al [10] utilized the discretized Reynolds equation to determine the leakage flow of a foil seal configuration built at Mohawk technologies. The CFS was assembled in two directions, with the anchored top foil side to the high-pressure and low-pressure zones respectively.

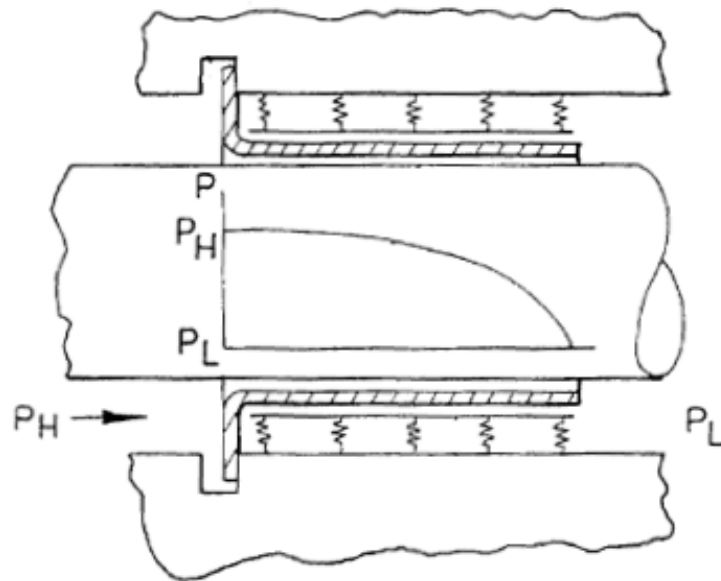

Figure 2-8 Anchored top foil facing high pressure zone, adopted from Ref [10]

The side flow was analyzed for various operating conditions. The deflection of bump & top foil was accounted in the film thickness equation while plotting the pressure distribution. They discussed the theoretical results for leakage flow plotted against differential pressure and eccentricity ratio.

Jiming Li et al [14] tested the gas damper seal, a modified version of labyrinth seal, for its rotor dynamic and leakage characteristics. Results were compared for two

types of gas damper seals viz., Honeycomb and pocket damper seals. The seal was mounted on a test rig with two ball bearings instead of hydrodynamic ones to ensure evaluation of seals by reduced damping.

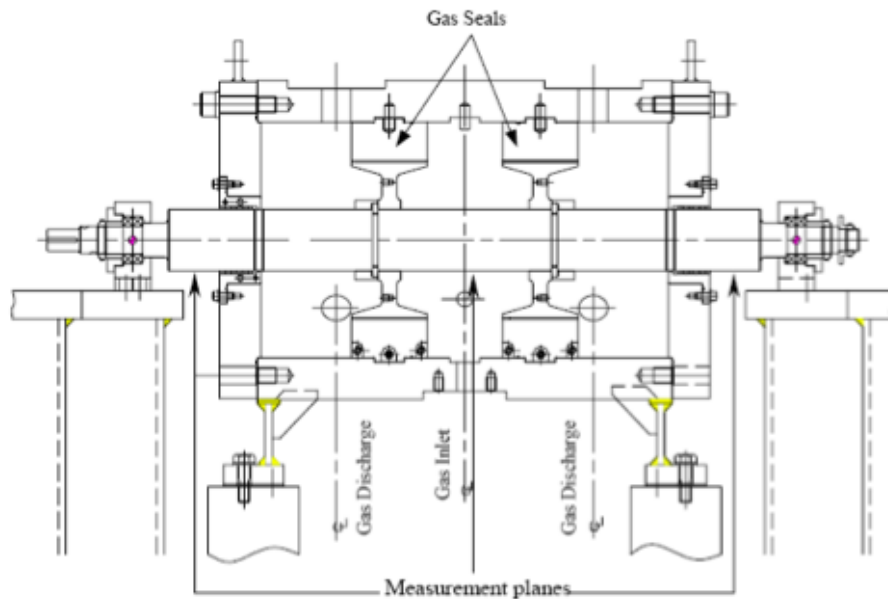

Figure 2-9 Test rig configuration with two ball bearings and identical seals, adopted from

Ref [14]

They installed identical seals supported by a horizontally split casing as shown in the figure below, through which the nitrogen gas (working fluid) is supplied. They mentioned that the axial thrust loads to the bearings is minimized as the leakage flow takes place in opposite directions symmetrically to the casing.

Radil et al [15] discussed on the importance of radial clearance of foil air bearings. In gas lubricated bearings, radial clearance is very small that there is hardly any gap when the shaft is at static condition. They conducted load capacity tests to determine how the variations in radial clearance affect bearing performance. Radial

clearance was measured by load deflection test with dial indicators. Insufficient radial clearance caused difficulty in shaft-bearing assembly, resulted in excessive start-up torque and reduction in load capacity. There was thermal runaway and bearing seizure when radial clearance is less than optimum. They also concluded that there is instability in the system when clearance is maintained larger. Hence it is very critical to design an optimum clearance and this is applicable to a foil seal as well, the measurement and effect of which is discussed in later chapters.

Chapter 3

Research Objective

Investigations are consistently being done to improve the overall performance of foil seals. As a result of which their reliability to be applied in gas compressors, turbines and other such turbo machines increases. Because the seals serve the purpose of reducing the leakage losses that directly affects the system efficiency. The conventional seals have the drawbacks of not complying with the rotor growth due to which larger clearances have to be maintained. This gave rise to the adoption of compliant foil seals from the gas bearings, which function at very low radial clearances. Studies determine that the leakage characteristics of a compliant foil seal are largely dependent on its geometry.

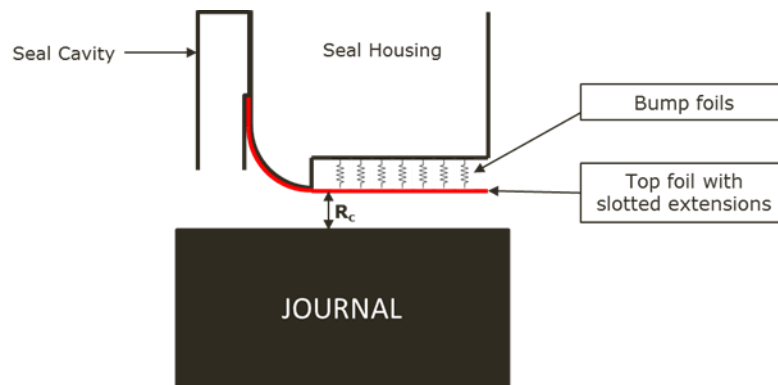

Figure 3-0-1 Schematic of Basic configuration tested in this study

The relation between the design parameters and the performance of foil seals forms the basis for the issues addressed in this research work. Optimum radial clearance shown in the figure above as R_c , differential pressure across the seal and rotor speeds are some of the crucial factors that needs to be identified and standardized for a foil seal geometry. This study focuses on design of a reconfigurable foil seal and discussion of issues occurring during the static and dynamic conditions on a test rig. Also gives a

scope for design improvements and attain continuous operation to validate the leakage characteristics of the foil seal at higher speeds and differential pressures.

Chapter 4

Experimental Setup

The details of the test rig used for experimental evaluation of the foil seal are discussed in this chapter. Fabrication & Assembly of the foil seal is also explained in detail.

The test rig primarily consists of the following parts,

1. Electric motor
2. Pedestal housing with ball bearing
3. Foil seal
4. Torque measuring device
5. Loading mechanism
6. Pressure Transducer
7. Mass flow meter

4.1 Test rig configuration

A journal shaft press fitted onto the main shaft through a ring adapter (SS 316) at the center was assembled with two ball bearing housings (GMN high precision ball bearings). The main shaft was connected to a 10KW induction motor, which has a rating of 70,000rpm, through a high precision flexible coupling. The whole configuration designed and employed by [12] was mounted on a vibration free table. The foil seal assembly was assembled on the center of the shaft with the loading mechanism and other measuring instruments.

1.1 Foil seal

Foil seal assembly comprises of a Set of Foil seals, which includes the seal housing, the top foil and the bump foils and a seal holder.

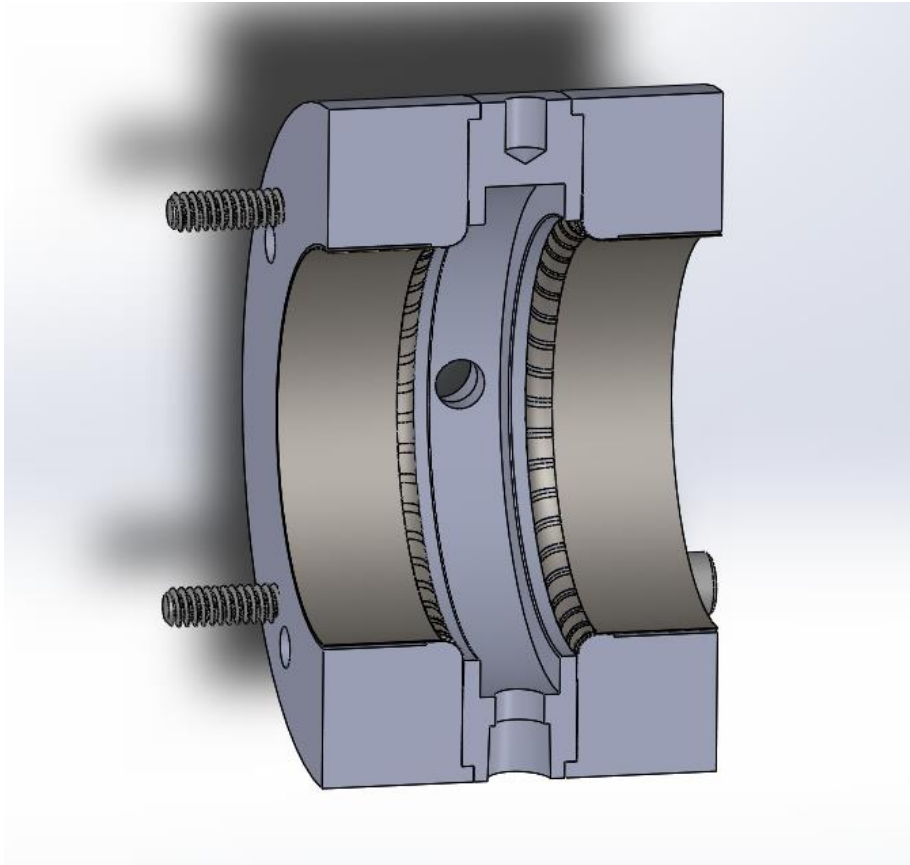

Figure 4-1 Sectional view of Foil seal assembly

Foil seal specification is in the Table 4.1.

4.1.1.1 Seal cavity

Seal housing was fabricated at UT Arlington machine shop using the material SS304.

The housing acts as the center part supporting the set of foil seals on both sides by holding the edges of top foil (Described later). It has provisions for the loading mechanism, torque measurement, pressure transducer and Pressurized air supply as shown in the Figure 4-2.

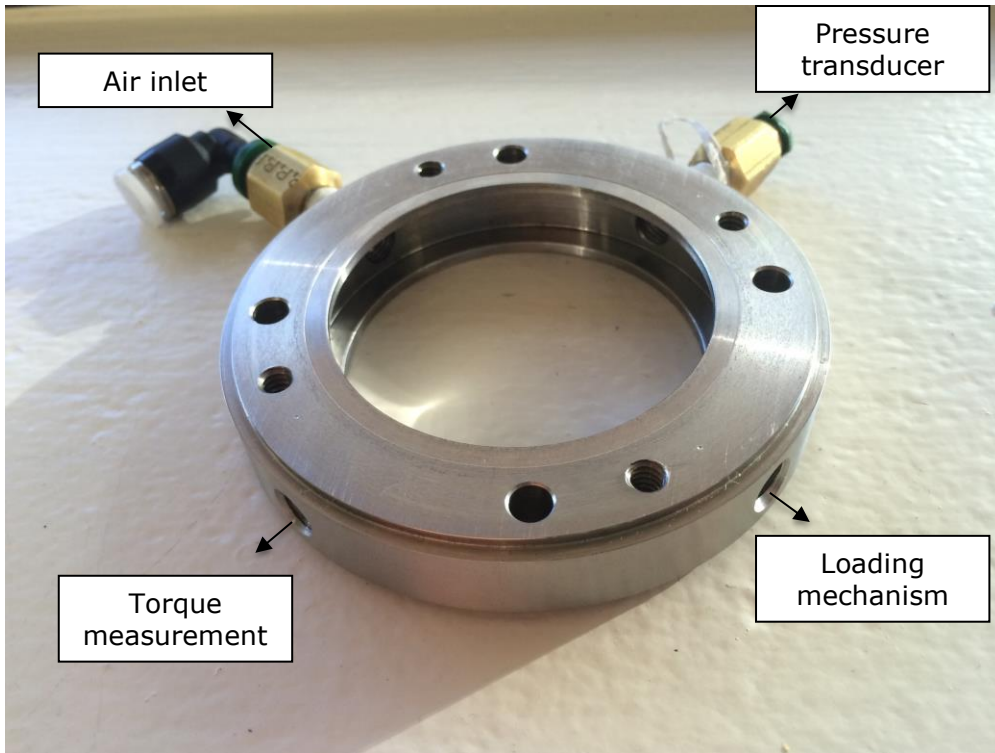

Figure 4-2 Seal cavity

Table 4-1 Foil seal basic specification

Detail	Dimension
Rotor diameter	49.0
Sealing surface	13.0
Seal assembly length	49.87
Top foil thickness	0.076
Bump foil thickness	0.076
Bump height	0.4
All dimensions are in mm	

4.1.1.2 Seal housing

It acts as the functional part providing the sealing surface. Bump foils and top foil are mounted onto this part

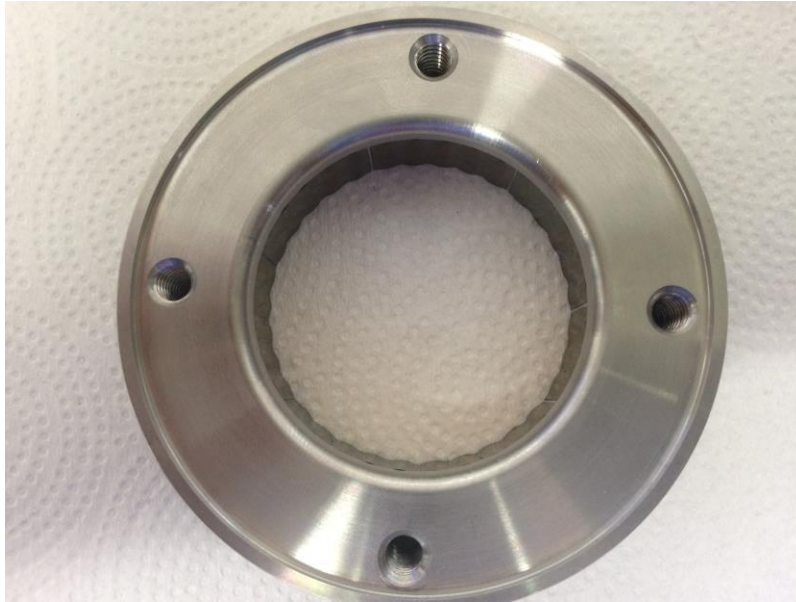

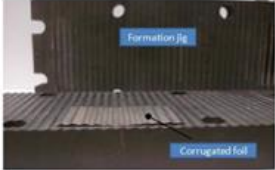
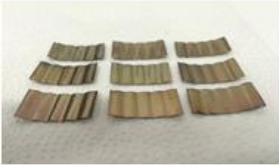

Figure 4-3 Seal housing

4.1.1.3 Bump foils

Bumps foils have the corrugated structure that gives the stiffness and damping to the journal and their formation is very important as it reflects the performance of bearing. The bump foil formation procedure is shown in the Table 4-2. The foils are finally heat treated in a furnace; heat treatment procedure is as follows: The bump foils are placed in furnace → Furnace is turned on → The * & down arrow buttons on the furnace are pressed at the same time for 6 seconds to see 'run on' → 'run off' → 'run on'. Releasing the buttons, the heat treatment cycle (Program 2) for Inconel 718 is restarted.





Table 4-2 Bump foils fabrication procedure

Steps	Procedure	
1	Sheet metal of the material Inconel 718 and thickness 0.076mm (3 mil) is cut into blanks of the dimensions 25mmx13mm.	
2	The blanks are thoroughly cleaned and a customized jig is used to form the corrugated bump foils.	
3	The blanks are placed onto the jig and pressed using a Hydraulic press ensuring there are 5 bumps/bump foil.	

4.1.1.4 Top foils

The top foil with slots cut along the curvature is placed over the bump foil. This inner top foil acts as a protective layer over the bump foils and the forming procedure is as follows,

Table 4-3 Top foil fabrication procedure

Steps	Procedure	
1	Sheet metal of the material Inconel 718 and thickness 0.076mm (3 mil) were cut into blanks of the dimensions 155.1mmx22.85mm.	
2	The slits were accurately marked and hand cut using scissors, then the foil blanks are pressed in the hydraulic press to make them flat.	
3	Seal holder with a flat base is used to hold the top foil along the sealing surface circumference. The slits on the foil are hand pressed onto to the curved surface of the holder to create the desired curvature (Radius: 2.54mm)	
4	The housing and the holder were assembled to check if the placement of top foil is proper and ensured there is no gap for air to pass through the slits	

Outer top foil does not have any curvature and it acts the primary bearing/sealing surface. This layer was fabricated for two designs viz., single pad foil seal and three pad foil seal. SS316 material of 4-mil thickness was used to fabricate the outer layer and since it was already ductile, no heat treatment was done. For single pad design, the SS sheet was cut into a blank of 154x14 mmxmm; for the three-pad design, it was cut into 3 equidimensional pieces of 51.33x14 mmxmm.

4.1.2 Foil seal assembly

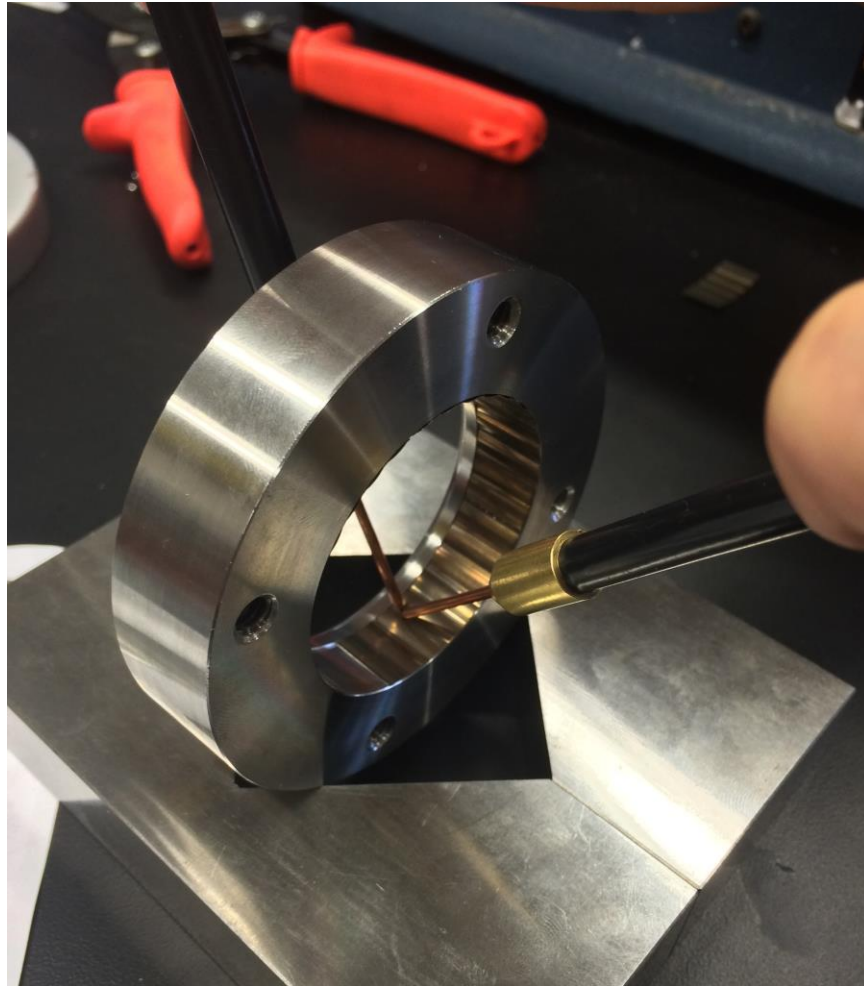

Figure 4-4 Bumps foils spot welded onto housing

Each foil seal has almost seven bump foils. They are spot welded along the circumference of the seal housing as shown in the figure,

4.1.2.1 Basic configuration

Top foil assembly varied slightly for the three configurations tested in this work. For the first configuration, where the radial clearance was 60 microns, the inner top foil, similar to

the procedure done in forming, is pressed to the curvature of seal holder, resting on the bump foils, is assembled with the seal housing and pressed fit. Same procedure is followed for the other foil seal that is symmetric over the housing. There was only one layer of top foil used in this case.

4.1.2.2 One pad foil seal

In this case, two layers of top foil (Inconel and SS) are used. This configuration was designed to reduce the radial clearance from 60 microns to 35 microns.

The assembly procedure is as follows,

Table 4-4 One pad foil seal assembly procedure



Steps	Procedure	
1	Top foil of the material Inconel 718 and SS 316 of 3mil and 4 mil thickness respectively were fabricated in required dimensions. Burrs were removed to create soft edges.	
2	The SS top foil is placed on the inconel layer in such a way that the it faces the journal and spot welded in one spot.	
3	Similar to the previous case, the inner top foil along with the outer layer is assembled to the seal holder over the bump foils.	



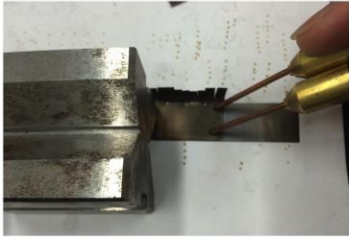
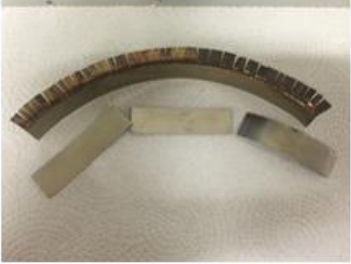

Figure 4-5 One pad foil seal

4.1.2.3 Three pad foil seal



Figure 4-6 Three pad foil seal

Table 4-5 One pad foil seal assembly procedure

Steps	Procedure	
1	<p>Top foil of the material Inconel 718 and SS 316 of 3mil and 4 mil thickness respectively were fabricated in required dimensions. Burrs were removed to create soft edges.</p>	
2	<p>The three SS top foil pieces are placed on the inconel layer in such a way that they face the journal, rolled over a circular shaft and spot welded in two spots/piece</p>	
3	<p>Similar to the previous case, the inner top foils (3) along with the outer layer is assembled to the seal holder over the bump foils.</p>	

This design was introduced with the objective of overcoming the limitations in the one pad foil seal. The radial clearance remained same.

After bolting from both the sides, the foil seal assembly is moved back & forth over the journal to check the fitment & clearance.

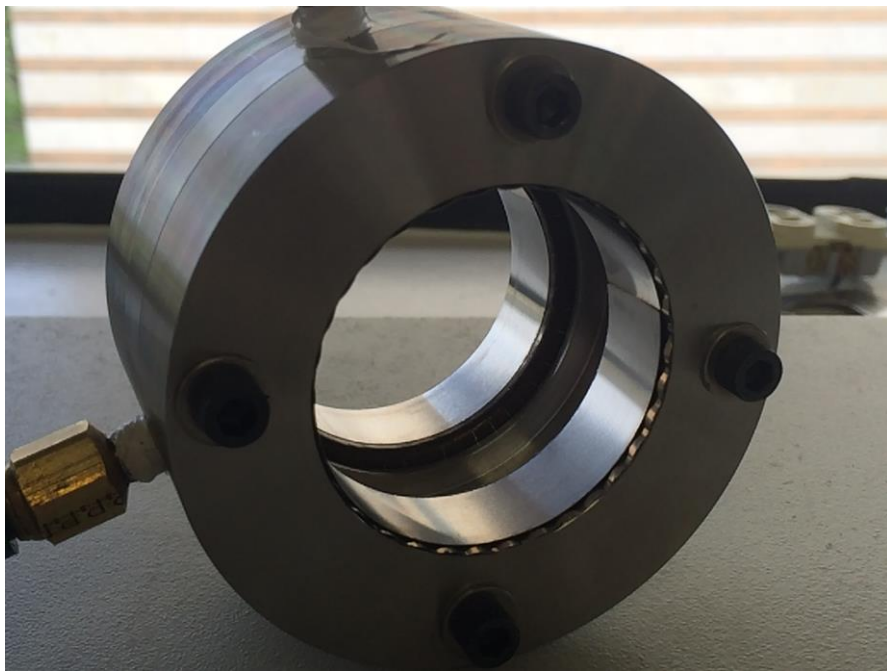

Figure 4-7 Foil seal assembly

4.1.3 Measuring instruments

4.1.3.1 Pressure transducer

Pressurized air supply to the seal was monitored using a pressure transducer (PX409-100G5V) from Omega, Inc., with a maximum capacity of 100 psig. The output signal from the sensor was fed to the NI chassis through NI9205 input module. The chassis was connected to computer, which used a Lab view VI that processed the voltage to give the pressure value.

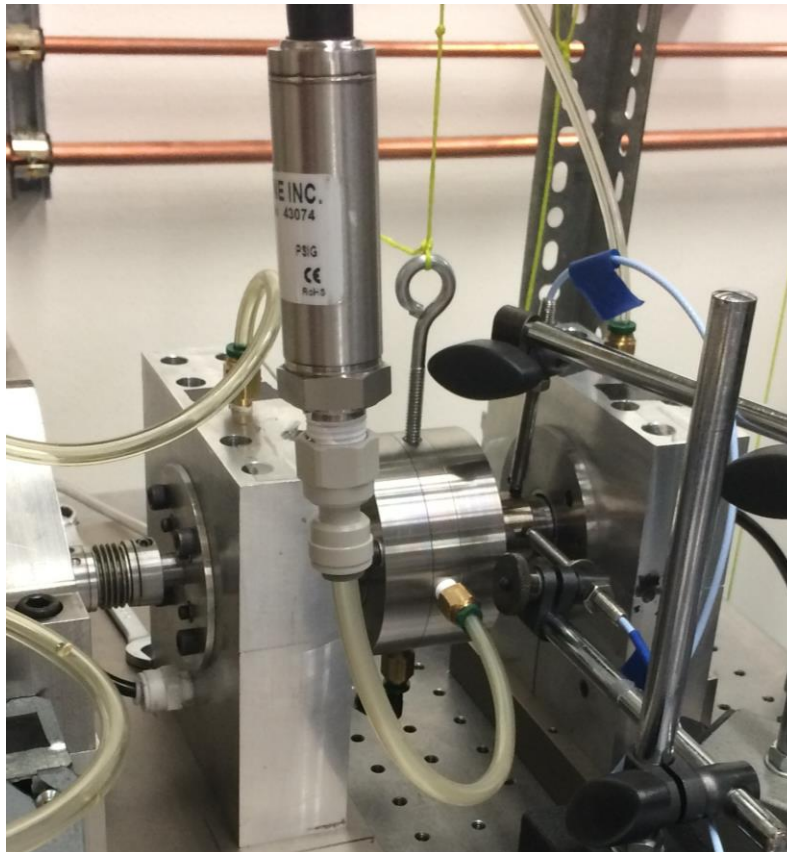

Figure 4-8 Pressure transducer plugged into seal cavity

4.1.3.2 Torque Monitoring

A torque rod, connected to a preloaded load cell (15lb) was attached to the seal housing horizontally. This was mounted in order to obtain the friction force value. The signal from PCB Load cell was conditioned in a PCB ICP Sensor conditioner (Model 482A22) and transferred to computer through NI USB 6259. LabVIEW processed those signals and displayed them as Force & Torque values for a rod length of 156mm. The load cell was calibrated before use and the gain & offset values were derived for further usage.

4.1.3.3 Flow meter

OMEGA FMA 1700/1800 Series flow meter was used to determine the leakage through the seal. It was connected to a power supply. The pressurized air to the seal from given through this flow meter and initially set to a flow value, as shown in the figure below,

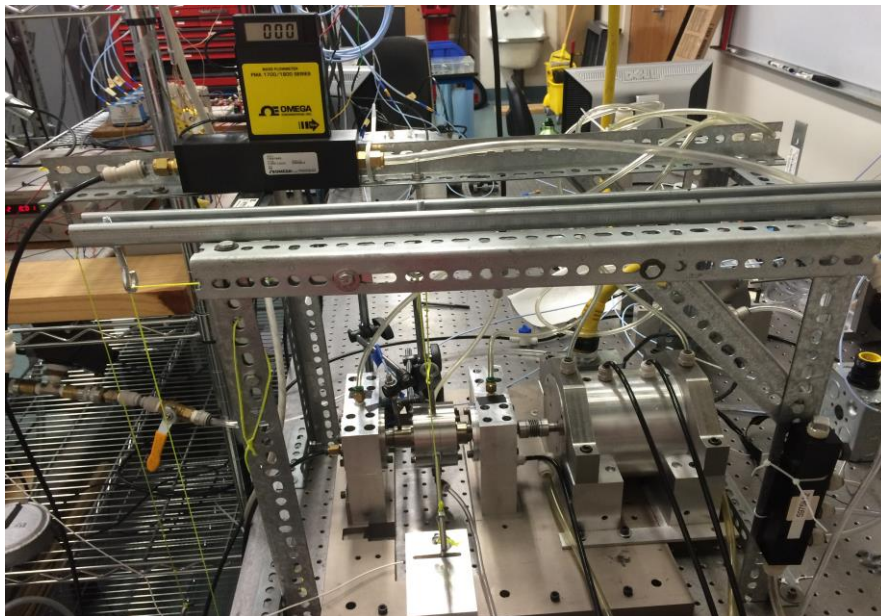

Figure 4-9 Test rig setup with instrumentation

4.1.4. Loading mechanism

The foil seal assembly was loaded by 3lb dead weight to balance its own weight through string-hook mechanism (Almost similar to pulley). This ensured uniform clearance throughout the circumference. The corresponding radial clearance was measured through a push-pull mechanism, which is described in the next chapter.

Chapter 5

Results and discussion

5.1 Radial clearance measurement

Push pull mechanism was adopted to measure the radial clearance (R_c) of the foil seal prior to the testing. The setup for this measurement is shown in the figure below,

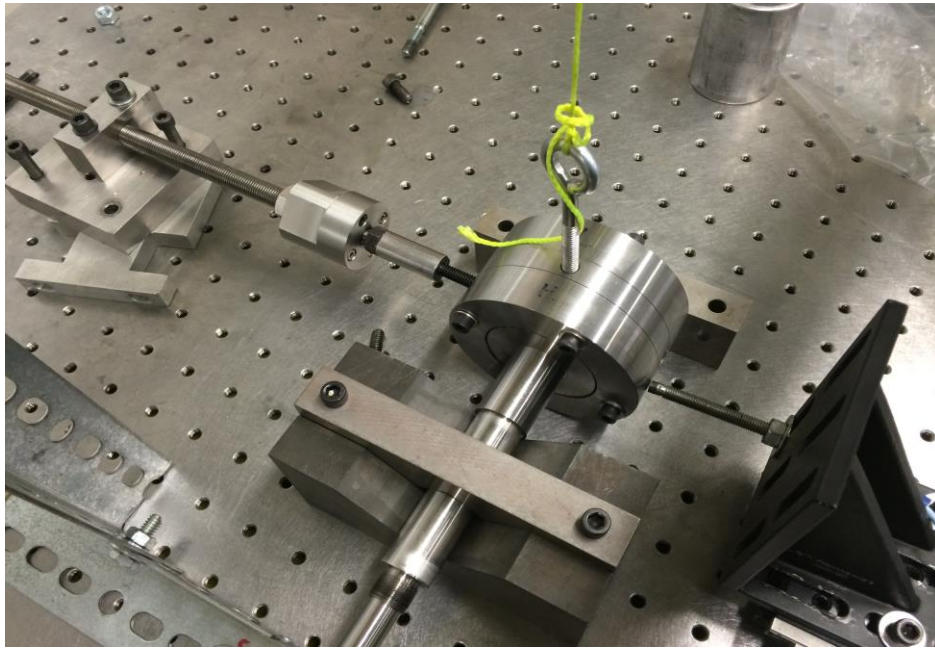

Figure 5-1 Setup to measure Radial clearance

The shaft was mounted on a V-block and was firmly supported to arrest its motion in all directions. The foil seal was mounted on the journal. A fixed pedestal with a long screw rod and an arrangement that caused linear movement to push and pull the foil seal when the rod was rotated was used. A static load cell (OMEGADYNE LCFD 500) was installed between this arrangement and the foil seal. An inductive type proximity sensor was used to measure the displacement of the seal housing (Foil seal assembly). The inductive type probe was calibrated before use.

The data was recorded for number of cycles and the load-deflection graph was plotted. The portion where the load cell had no change in the value was considered to be the total clearance (T_c). Hence the radial clearance was computed as follows,

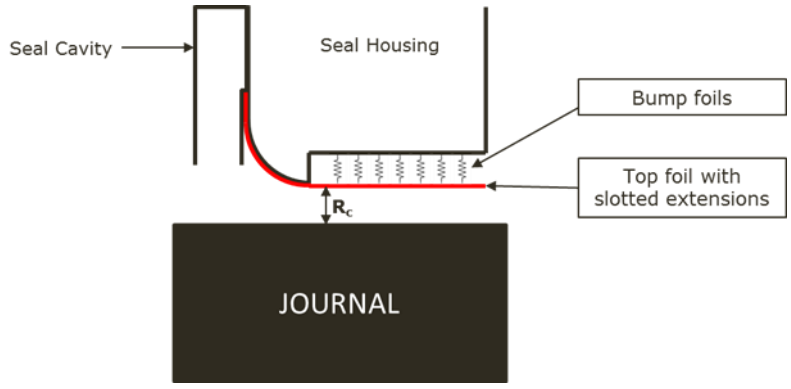

Figure 5-2 Basic configuration

$$R_c = T_c/2 \dots \dots \dots (5.1)$$

The measured radial clearance was 60 microns for the basic configuration.

5.2 Seal characteristics

As seen in the following table, there was sealing effect achieved using the basic configuration. Also, there were frictional issues during the stopping condition, which gave rise to abrupt stop of rotor and a lot of noise.

Table 5-1 Basic configuration

	Start	18000RPM	Stop
Leakage (LPM)	109	109	109
Pressure (psi)	2.82	2.82	2.82

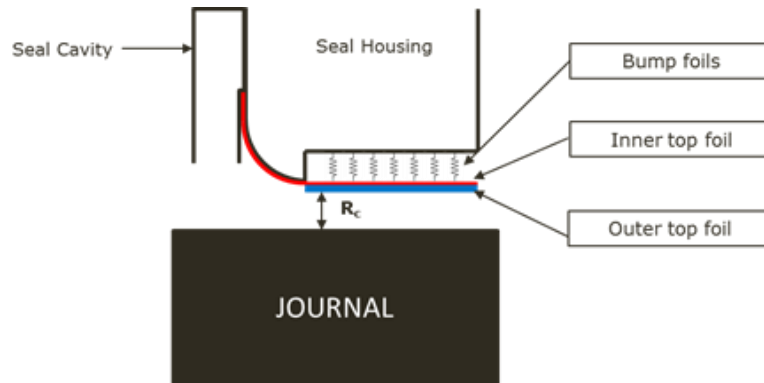

Figure 5-3 One pad foil seal configuration, 60 microns

Analyzing the foil seal assembly after the test, the non-uniform bulge in the curvature (In the slotted extensions of top foil) throughout the circumference seemed to create the frictional issue. Hence a circular layer of top foil was added onto the existing configuration as shown in the Figure below, without changing the radial clearance (60 microns).

As anticipated, the frictional issue was eliminated during the next test. But the sealing effect was still not achieved. There was no change in the leakage flow value and the pressure inside the cavity.

Table 5-2 Leakage flow: One pad foil seal 60 microns

	Start	18000RPM	Stop
Leakage (LPM)	108	108	108

The pressure rise at the static condition was just above the atmospheric pressure. It was expected to be considerably higher than the atmospheric pressure as the foil seal was assembled on the journal with close clearance. The red dotted line in the differential pressure plot shows the pressure at static condition

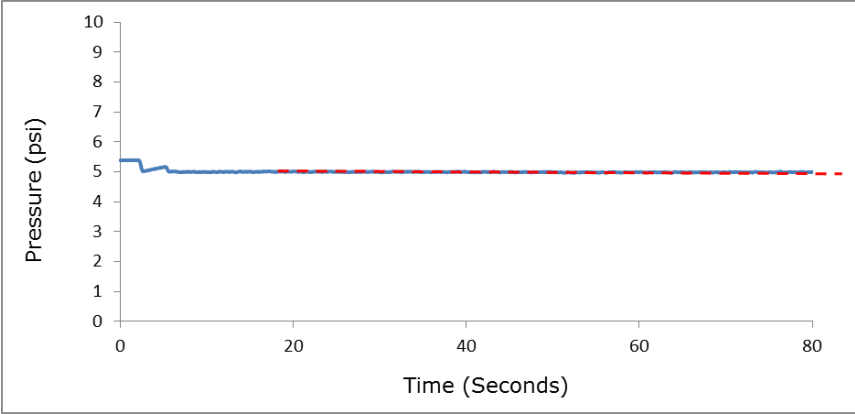

Figure 5-4 Differential pressure plot over time

The differential pressure was roughly estimated across the seal for this geometry assuming it to be a laminar flow using the following equation,

$$Q = \frac{\pi d^4}{(4)(32)lv\rho} \Delta p \dots\dots\dots (5.2)$$

Where,

Q is the volumetric flow rate (m³/s)

D is the hydraulic diameter (m)

l is the sealing surface length (m)

U is the Kinematic viscosity (m²/s)

ρ is the density (kg/m³)

ΔP is the differential pressure (kg/m.s²)

It indicated that the clearance has to be at least 2.5 times lower than the existing value to attain a considerable pressure rise at static condition. Another countermeasure to confirm that the radial clearance was affecting the sealing action was done by adding a layer of scotch tape (0.02mm thick) onto the shaft and the pressure was checked at static condition. With a positive rise in the pressure and also reviewing the literature [1-7], reduction in the radial clearance seemed to be a potential solution for this problem. The result achieved using a one pad foil seal configuration with a radial clearance of 35 microns is shown in the figure 5-6. This was done by changing the outer top foil thickness to 4 mil (0.004inch) from 3 mil (0.003inch). There was considerable reduction in the amount of leakage flow and also a pressure rise inside the seal cavity.

Table 5-3 Leakage flow, One pad foil seal 35 microns

	Start	18000RPM	Stop
Leakage (LPM)	106	94	104

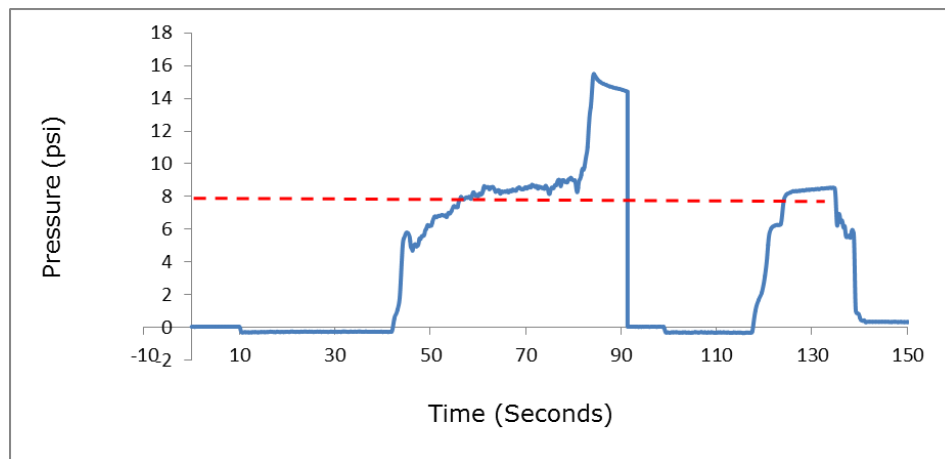

Figure 5-5 Differential pressure plot over time, One pad foil seal 35 microns

The leakage flow was measured up to a speed of 18000rpm, as there was an issue of top foil coming out. The outer layer of top foil, spot welded onto inner layer at a single point, could not withstand higher speed. It showed the same behavior after testing it for several times.

To eliminate this issue, three pad configuration, which is a concept tested & proven better by Kim et al [16, 17] for foil bearings, was adopted for the foil seal. The three pads which formed the outer layer of top foil were spot welded individually. This ensured a rigid support to the outer top foil, which directly faced the journal.

Table 5-4 Leakage flow, Three pad foil seal 35 microns

	Start	18000RPM	Stop
Leakage (LPM)	100	84	100

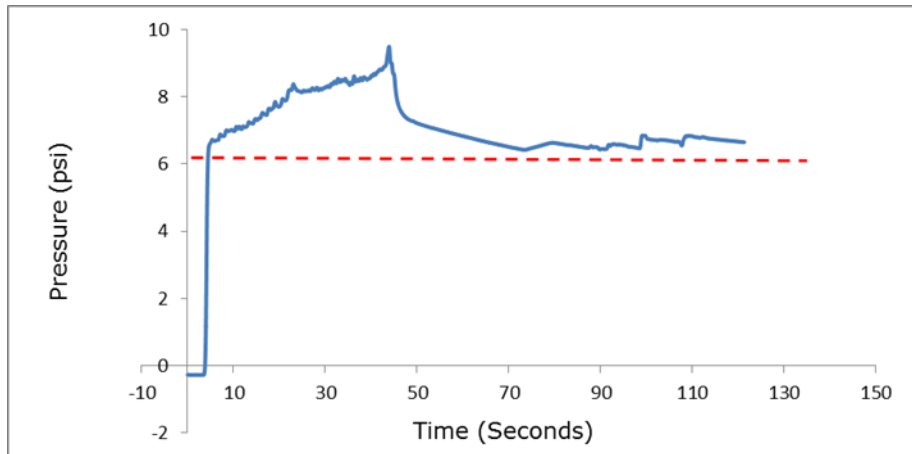

Figure 5-6 Differential pressure plot over time, Three pad foil seal 35 microns

5.3 Result summary

The seal performance determined until 18000rpm is summarized as follows for the one pad and three pad foil seals for the case of radial clearance of 35 microns.

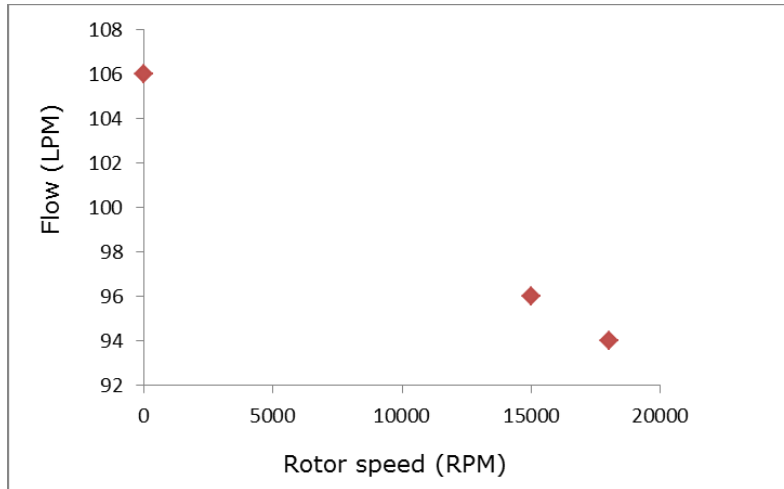

Figure 5-7 Leakage flow vs Rotor speed, One pad foil seal

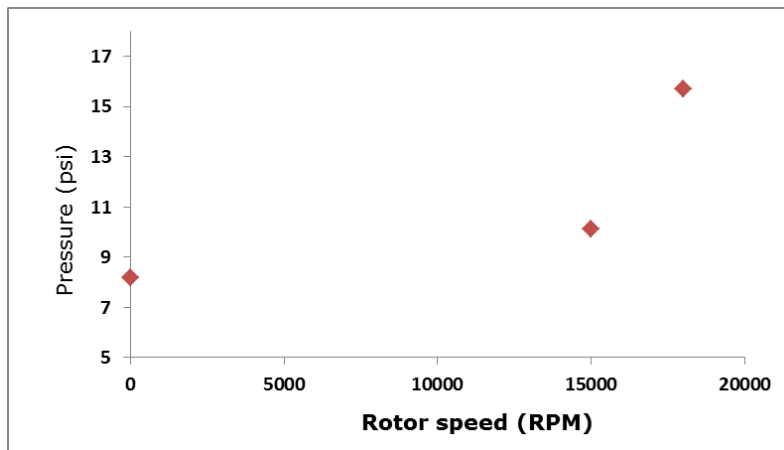

Figure 5-8 Pressure vs Rotor speed, One pad foil seal

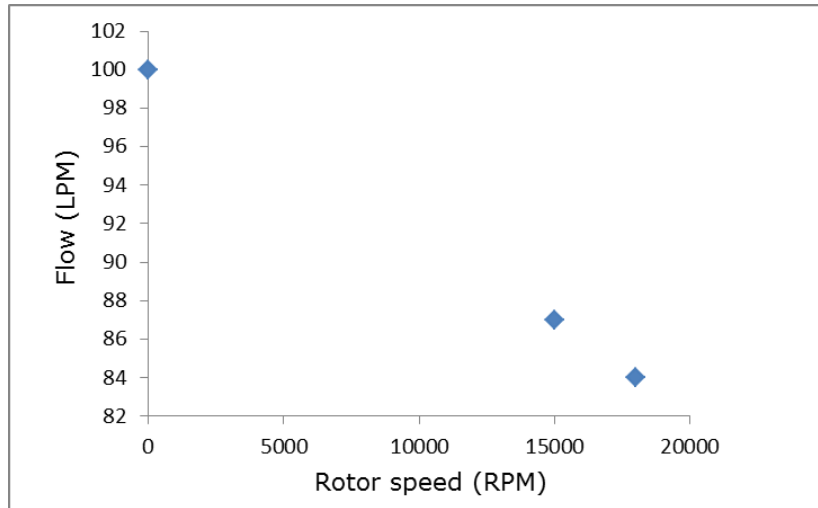

Figure 5-9 Leakage flow vs Rotor speed, Three pad foil seal

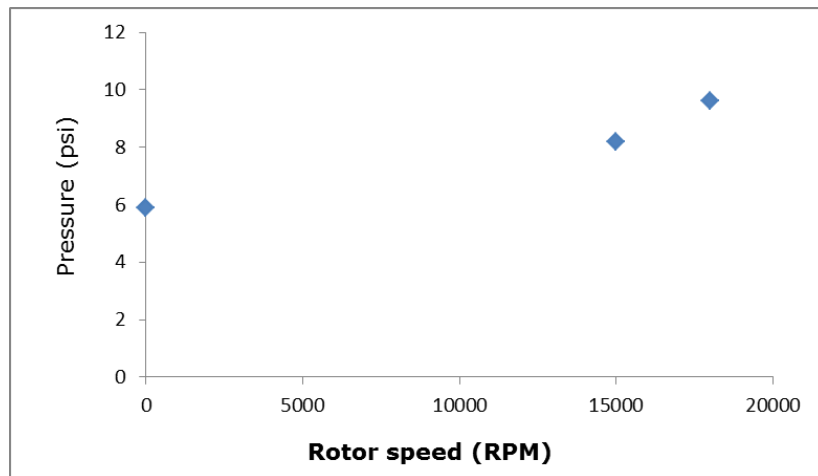

Figure 5-10 Pressure vs Rotor speed, Three pad foil seal

Delgado and Proctor [8, 9] recommended a flow factor ' Ψ ' to compare the leakage characteristics for various seal geometries and operating conditions. Hence the performance of the configurations tested using the following equation,

$$\text{Flow factor, } \Psi = (m \cdot \sqrt{T}) / (P \cdot D) \text{ (kg} \cdot \text{K}^{0.5} / \text{MPa} \cdot \text{m} \cdot \text{s)}$$

Where,

m is the mass flow rate (kg/s)

T is the supply temperature (K)

P is the cavity pressure (MPa)

D is the rotor diameter (m)

Although the one pad foil seal seems to perform better than three pad foil seal at 18000rpm, it does not withstand higher speeds. To validate the actual performance of the three pad foil seal, it has to be tested at higher rotor speeds and differential pressure.

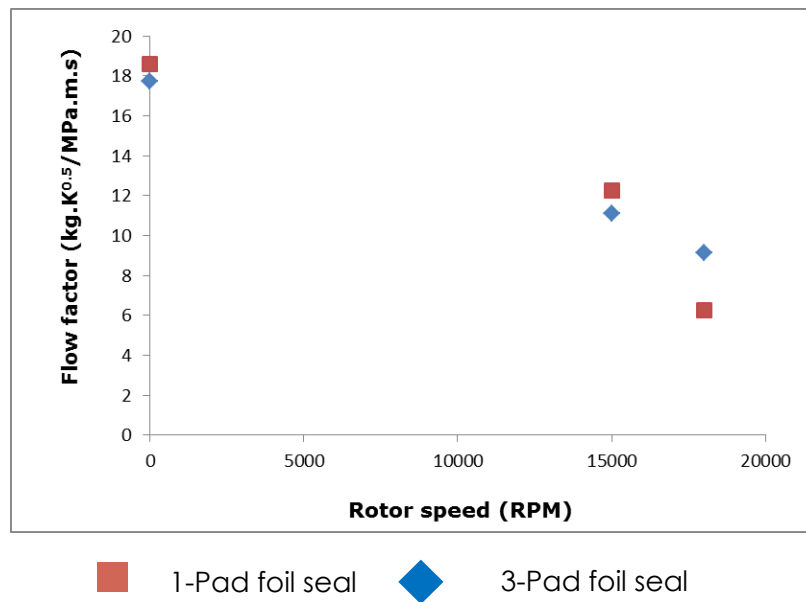

Figure 5-11 Flow factor comparison

Chapter 6

Conclusion and Future scope

Radial clearance turned out to be an important factor in the functioning of foil seal, agreeing to the conclusions made in [4]. The curvature of the slotted extensions in the top foil has to be given more attention, as it leads to frictional issues.

The results show that the one pad and three pad foil seal concepts showed significant sealing effect although higher speeds were not achievable using both the concepts. The CFS tested was up to 18000rpm in both the configurations. One of the sustained issues is near the curvature area of the top foil which is prone to wear & tear, in turn causing damage to the shaft. Three pad foil seal being sturdier in operation, fabrication methods and the precision of the parts (Especially top foils) can be improved to run beyond 18krpm. To further improve the leakage performance of the foil seal, it has to have a continuous operation.

Customized and dedicated tool to form the inner top foil layer might give a better edge than the existing hand press method. Fewer modifications in the design and improvement in the accuracy of current fabrication method can give rise to an extended operating range to study the seal and improve its sealing capacity. Temperature rise during the operation can be monitored and high temperature conditions can also be studied. Before any further testing of the foil seal, it is also necessary to simulate the leakage performance for the current foil seal geometry.

Appendix A

Posttest inspection of foil seal

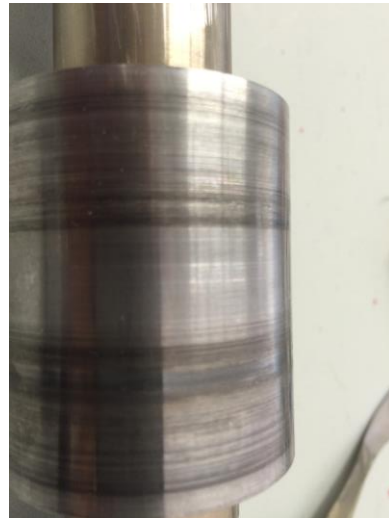
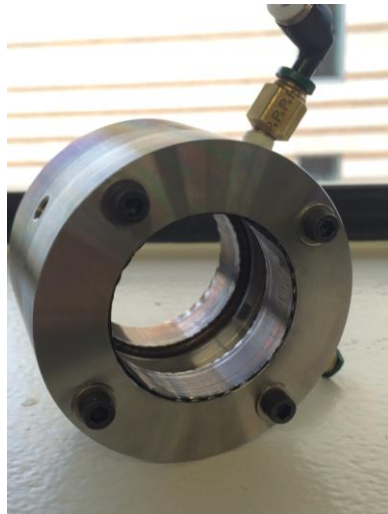
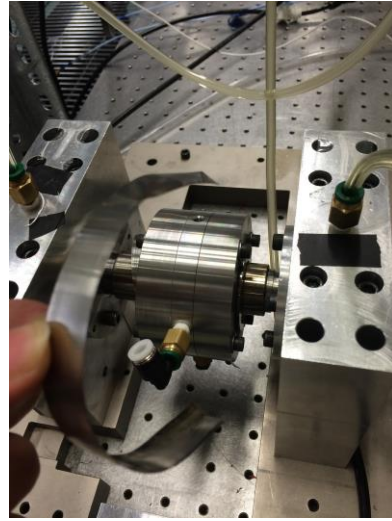
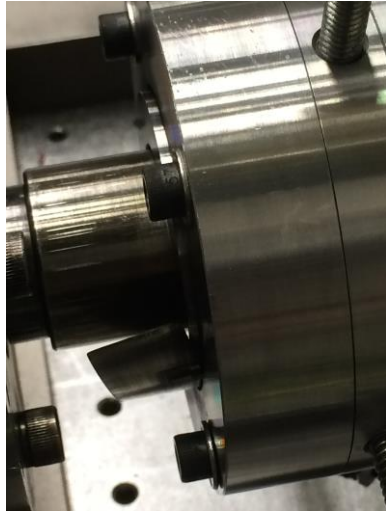

Figure A-1 Pictures showing posttest conditions of foil seal and shaft in one pad and three pad configurations

Bibliography

- [1] Salehi, M., Heshmat, H., Walton, J. F., Cruzen S., 1999, "The Application of Foil Seals to a Gas Turbine Engine", AIAA paper 99-2821, 35th AIAA/ASME/SAE/ASEE joint Propulsion Conference & Exhibit, June 20-24, Los Angeles, CA.
- [2] Salehi, M., Heshmat, H., 2000, "HIGH TEMPERATURE PERFORMANCE EVALUATION OF A COMPLIANT FOIL SEAL", AIAA paper 99-2821, 36th AIAA/ASME/SAE/ASEE Joint Propulsion Conference & Exhibit 17-19 July, 2000, Huntsville, Alabama
- [3] Salehi, M., Heshmat, H., 2001, "ANALYSIS OF A COMPLIANT GAS FOIL SEAL WITH TURBULENCE EFFECTS", AIAA paper 99-2821, 37th AIAA/ASME/SAE/ASEE Joint Propulsion Conference & Exhibit 8-1 July, 2001 Salt Lake City, Utah
- [4] Heshmat, H., Jahanmir, S., Hunsberger, A., Walton, J. F., 2013, "Oil free Bearings and seals for Hydrogen Centrifugal Compressor", Tribology Online, 8, 1 (2013) 44-63.
- [5] Proctor, P. M., Delgado, I., 2003, "Compliant Foil Seal Investigations", 2003 NASA Seal/Secondary Air System Workshop, November 5-6, 2003
- [6] Salehi, M., Heshmat, H., 1999, "Performance of a Compliant Foil Seal in a Small Gas Turbine Engine Simulator Employing a Hybrid Foil/Ball Bearing Support System", Tribology Transactions, Vol 44 (2001), 3, 458-464.
- [7] Salehi, M., Heshmat, H., 2002, "EVALUATION OF LARGE COMPLIANT FOIL SEALS UNDER ENGINE SIMULATED CONDITIONS", AIAA-02-3792, 38th AIAA/ASME/SAE/ASEE Joint Propulsion Conference & Exhibit, 7-10 July 2002, Indianapolis, Indiana.
- [8] Delgado, I. R., Proctor, M. P., 2006, "Continued Investigation of Leakage

and Power Loss Test Results for Competing Turbine Engine Seals,” AIAA Paper No. 2006-4754.

[9] San Andres, L., Anderson, A., 2015, “An All-Metal Compliant Seal Versus a Labyrinth Seal: A Comparison of Gas Leakage at High Temperatures,” ASME Transaction, Vol 137 (2015), 052504, 1-8.

[10] Aksoy, S., Dogu, Y., Faruk, M., 2010, “A SIMPLE FEM MODEL FOR FOIL BEARINGS UNDER DIFFERENTIAL PRESSURE”, IJTC2010, Proceedings of the STLE/ASME 2010 International Joint Tribology Conference, October 17-20, 2010, San Francisco, California, USA

[11] Heshmat, H., 2003, "Compliant Foil Seal" US Patent No. 6,505,837 B1.

[12] EXPERIMENTAL FEASIBILITY STUDY OF RADIAL INJECTION COOLING OF THREE-PAD RADIAL AIR FOIL BEARINGS, SUMAN K SHRESTHA, M.S. Thesis, University of Texas at Arlington, August 2012

[13] Heshmat, H., 2010, “Advanced sealing technology for Hydrogen compressors”, June 7 2010.

[14] Li, J., De Choudhury, P., Kushner, F., 2010, “Gas damper seal test results, theoretical correlation and applications in design of high pressure compressors”, Proceedings of 29th Turbo machinery conference.

[15] Radil, K., Howard, S., and Dykas, B., 2002, "The Role of Radial Clearance on the Performance of Foil Air Bearings”, STLE Tribology Transaction, 45(4), pp. 485-490.

[16] Kim, D., Lee, D., 2010, “Design of Three-Pad Hybrid Air Foil Bearing and Experimental Investigation on Static Performance at Zero Running Speed”, ASME Transaction, Vol 132 (2010), 122504, 1-10.

[17] Kim, D., Lee, D., Sadashiva, R., 2011, “Transient Thermal Behavior of

Preloaded Three-Pad Foil Bearings: Modeling and Experiments”, ASME Transaction, Vol
133 (2011), 021703, 1-11.

Biographical Information

Sashidhar Raghuraman graduated from PSG College of Technology, India in 2011 with Bachelor's degree in Mechanical Engineering. He worked at Maruti Suzuki India Limited as a Project Engineer for two years facilitating new model development for Engine Cylinder heads and blocks. He joined UT Arlington in fall 2013 to pursue Master's degree and then he commenced his research work involving performance evaluation of compliant foil seals.