

LARGE DIAMETER STEEL PIPE FIELD TEST USING CONTROLLED LOW  
STRENGTH MATERIAL AND STAGED CONSTRUCTION MODELING  
USING 3-D NONLINEAR FINITE ELEMENT ANALYSIS

by

FRANCIELE BELLAVER

Presented to the Faculty of the Graduate School of  
The University of Texas at Arlington in Partial Fulfillment  
of the Requirements  
for the Degree of

MASTER OF SCIENCE IN CIVIL ENGINEERING

THE UNIVERSITY OF TEXAS AT ARLINGTON

December 2013

Copyright © by Franciele Bellaver 2013

All Rights Reserved



### Acknowledgements

I would like to express my sincere gratitude to my research adviser Dr. Ali Abolmaali for giving me the opportunity to work in this research topic. I appreciate all the effort, time, and support he gave me during my academic carrier. I would like to thank the other members of my committee, Dr. Shih-Ho Chao and Dr. Sahadat Hossain for the knowledge and advice they have shared throughout my graduate studies.

A special thanks goes to Mojtaba Dezfooli and Mohammad Razavi for their time spent helping me in the development of the finite element models in the Center for Structural Engineering Research. Also, to Dr. Yeonho Park for his hard work and for making the filed test possible with his experimental experience.

I would like to thank Matt Gaughan, Tarrant Regional Water District, and City of Dallas for supporting and funding this research.

Finally, I would like to thank my family that always encouraged and supported my decision in pursuing a degree in the United States.

November 25th, 2013

Abstract

LARGE DIAMETER STEEL PIPE FIELD TEST USING CONTROLLED LOW  
STRENGTH MATERIAL AND STAGED CONSTRUCTION MODELING  
USING 3-D NONLINEAR FINITE ELEMENT ANALYSIS

Franciele Bellaver, M.S.

The University of Texas at Arlington, 2013

Supervising Professor: Ali Abolmaali

Using finite element methods and field tests, an extensive study on selected steel pipes is devised for the Integrated Pipeline Project in Dallas-Fort Worth, Texas. The project integrates Tarrant Regional Water District (TRWD) existing pipelines to the Dallas system along 150 miles.

Field test of buried pipes, monitoring the pipe in different trench conditions is extremely valuable in predicting the displacement of the pipe during construction stages and during its lifetime. The field instrumentation monitors the circular displacements and strains of a buried steel pipe with an outside diameter (O.D.) of 84 in. and 0.375 in. thickness in three different trench profiles using controlled low strength material. For the first case, the trench width is the O.D. plus 36 in., and CLSM is used as embedment up to 30% of the O.D. In the second case, the trench width is the O.D. plus 36 in., and CLSM is used as embedment up to 70% of the O.D. In the third case, the trench width is O.D. plus 18 in., and CSLM is used as embedment up to 70% of the O.D. From the CLSM to the top of the pipe, ordinary local soil is used and compacted to 95% standard proctor density. Approximately 5ft. of backfilling is added for all cases. For pipe structural monitoring, strain gages are attached inside and outside of the pipe to obtain the

circumferential strain, and displacement transducers are installed to record both vertical and horizontal diameter displacement.

The deflections of the steel pipes are effectively measured in each of the construction stages: the CLSM embedment, the soil compaction, and during the load of the 5ft. soil on top of the pipe. In addition, the buried pipes are monitored for long term deflection (around 350 days). The tests provide guidance for the finite element modeling and are an important study in predicting the structural performance of buried steel pipes.

The finite element analysis developed is a three dimensional (3D) nonlinear finite element model of steel pipe coupled with CLSM and compacted soil. The finite element model consists of the pipe and soil interaction during the staged construction of embedment and backfill. The geometry of the model is created based on the pipe's undeformed shape. Due to the effect of the loads during staged construction (i.e. subsequent layers of soil being added as embedment and/or backfill), the geometry of the pipe is distorted for each layer of soil around it. The model also considers the at rest lateral pressure and the lateral effect of soil compaction on the pipe-soil structure. Different trench conditions are modeled by varying the in-situ soil stiffness for the trench wall, and trench width. The finite element model developed simulates the load-deformation results of a buried steel pipe in different trench conditions and was verified by the field test results.

After developing the nonlinear finite element model for steel pipes and verifying the results with field test, the model can be used to predict pipe performance under varying backfill and loading conditions. All parameters that are modified in the models are part of the scope of the pipeline project, and are field situations that might be observed in the construction of the Integrated Pipeline.

## Table of Contents

Acknowledgements .....	iii
Abstract .....	iv
List of Illustrations .....	ix
List of Tables .....	xiii
Chapter 1 Introduction, Literature Review, Goals and Scope.....	1
1.1 Introduction .....	1
1.1.1 Buried Steel Pipe Mechanics – Soil Properties .....	6
1.1.2 Controlled Low Strength Material .....	9
1.1.3 Current Steel Pipe Design .....	11
1.2 Justification of this Research .....	14
1.3 Field Test and Finite Element Modeling Background.....	15
1.4 Goals and Scope .....	17
Chapter 2 Field Test.....	19
2.1 Introduction .....	19
2.2 Field Test Overview .....	20
2.3 Pipe Instrumentation.....	23
2.4 Field Test Installation – Trench Excavation and Pipe Laying.....	27
2.4.1 Trench Geometry and Surveying of the Trench .....	33
2.5 Field Test Installation – Embedment and Staged Construction .....	34
2.5.1 Controlled Low Strength Material Installation.....	36
2.5.2 CLSM Mix Design and Test Specimens.....	39
2.5.3 Soil Embedment and Compaction.....	41
2.6 Field Test Installation - Backfilling .....	42
2.7 Field Test Results .....	44

2.7.1 Deflection and Strains Pipe 1 .....	45
2.7.2 Deflection and Strains Pipe 2 .....	53
2.7.3 Deflection and Strains Pipe 3 .....	60
Chapter 3 Finite Element Analysis .....	67
3.1 Introduction .....	67
3.2 Finite Element Modeling .....	67
3.2.1 Geometry .....	68
3.2.2 Boundary Conditions .....	69
3.2.3 Loads .....	69
3.2.3.1 Vertical Loads .....	70
3.2.3.2 Horizontal Loads: Soil Lateral Loads .....	70
3.2.4 Material Behavior and Material Properties .....	71
3.2.5 Staged Construction .....	73
3.2.6 Contact Modeling .....	74
3.2.7 Mesh Size and Element type .....	75
3.3 Finite Element Results .....	75
3.3.1 Deflections .....	76
3.3.2 Strains .....	79
3.4 Finite Element Model Verifying .....	81
Chapter 4 Summary, Conclusion, and Recommendation .....	83
4.1 Summary .....	83
4.2 Conclusion .....	84
4.3 Recommendation .....	90
Appendix A Unconfined Compressive Strength Test Results for Controlled Low Strength Material .....	91

Appendix B Density Control and Proctor Degree of Compaction .....	110
Appendix C Soil Investigation of the Field Test Location (Rolling Hills Pumping Station).....	117
Appendix D Triaxial Test Results of the Field Test Native Soil.....	119
References .....	121
Biographical Information .....	124



## List of Illustrations

Figure 1- 1 Moments and thrust forces in a rigid concrete pipe.....	4
Figure 1- 2 Stress distribution across the wall of due to internal pressure .....	4
Figure 1- 3 Stress distribution across the wall of due to external pressure .....	5
Figure 1- 4 Stresses at the bottom of a flexible pipe .....	6
Figure 1- 5 Series of Mohr circles at soil slip and the strength envelope .....	7
Figure 1- 6 Comparison of embedment with and without Portland cement from ASCE Buried Flexible Steel Pipe (2009) .....	10
Figure 2 - 1 Trench profile for Pipe1, Pipe2 and Pipe3.....	20
Figure 2 - 2 Field Test set up Overview .....	21
Figure 2 - 3 Pipe 1 - Section1 and Section2 .....	22
Figure 2 - 4 Pipe 2 – Section1 and Section2 .....	22
Figure 2 - 5 Pipe 3 - Section1 and Section2 .....	23
Figure 2 - 6 Instrumentation Section1 and Section 2.....	23
Figure 2 - 7 Position of the strain gauges and displacement transducers.....	24
Figure 2 - 8 Displacement Transducer Sensor .....	24
Figure 2 - 9 Surface chemical cleaning preparation .....	25
Figure 2 - 10 Adhesive and protective coating .....	26
Figure 2 - 11 Strain gauge installed on the steel pipe wall .....	26
Figure 2 - 12 Data acquisition unit .....	27
Figure 2 - 13 Trench excavation .....	28
Figure 2 - 14 Steel trench box.....	29
Figure 2 - 15 Overview of the trench.....	30
Figure 2 - 16 Connection of the pipe and the vault.....	30
Figure 2 - 17 Pipe end closed with plywood .....	31

Figure 2 - 18 Pipe cross section of instrumentation.....	31
Figure 2 - 19 Concrete vault and cables path from the pipe to the DAQ headquarters ...	32
Figure 2 - 20 Data acquisition headquarter.....	32
Figure 2 - 21 Data acquisition scanners connected to the computers.....	32
Figure 2 - 22 Field test geometry overview.....	33
Figure 2 - 23 Schematics of the proposed trench configuration for Case 1 .....	35
Figure 2 - 24 Schematics of the proposed trench configuration for Case 2 .....	35
Figure 2 - 25 Schematics of the proposed trench configuration for Case 3 .....	36
Figure 2 - 26 Soil shredder .....	37
Figure 2 - 27 Traveling batch plant .....	37
Figure 2 - 28 CLSM placing overview .....	38
Figure 2 - 29 Pipe 1 after flotation.....	38
Figure 2 - 30 CLSM leaking inside pipe 1 .....	39
Figure 2 - 31 Nuclear moisture density meter.....	42
Figure 2 - 32 Sheep foot roller compactor .....	43
Figure 2 - 33 Compaction of the first backfilling layer.....	43
Figure 2 - 35 Soil layer surface after compaction .....	44
Figure 2 - 36 Displacement Pipe 1 – Section 1 .....	47
Figure 2 - 37 Displacement Pipe 1 – Section 2 .....	47
Figure 2 - 38 Monitoring Displacement Pipe 1 – Section 1.....	48
Figure 2 - 40 Strain Pipe 1 – Section 1 .....	49
Figure 2 - 41 Strain Pipe 1 – Section 2 .....	49
Figure 2 - 42 Strain Pipe 1 – Section 1 .....	50
Figure 2 - 43 Strain Pipe 1 – Section 2 .....	50
Figure 2 - 44 Strain Pipe 1 – Section 1 .....	51

Figure 2 - 45 Strain Pipe 1 – Section 2 .....	51
Figure 2 - 46 Monitoring Strain Pipe 1 – Section 1 .....	52
Figure 2 - 47 Monitoring Strain Pipe 1 – Section 2 .....	52
Figure 2 - 48 Displacement Pipe 2– Section 1 .....	54
Figure 2 - 49 Displacement Pipe 2– Section 2 .....	54
Figure 2 - 50 Monitoring Displacement Pipe 2– Section 1.....	55
Figure 2 - 51 Monitoring Displacement Pipe 2– Section 2.....	55
Figure 2 - 52 Strain Pipe 2 – Section 1 .....	56
Figure 2 - 53 Strain Pipe 2 – Section 2 .....	56
Figure 2 - 54 Strain Pipe 2 – Section 1 .....	57
Figure 2 - 55 Strain Pipe 2 – Section 2 .....	57
Figure 2 - 56 Strain Pipe 2 – Section 1 .....	58
Figure 2 - 57 Strain Pipe 2 – Section 2 .....	58
Figure 2 - 58 Monitoring Strain Pipe 2 – Section 1 .....	59
Figure 2 - 59 Monitoring Strain Pipe 2 – Section 2 .....	59
Figure 2 - 60 Displacement Pipe 3– Section 1 .....	61
Figure 2 - 61 Displacement Pipe 3– Section 2 .....	61
Figure 2 - 62 Monitoring Displacement Pipe 3– Section 1.....	62
Figure 2 - 63 Monitoring Displacement Pipe 3– Section 2.....	62
Figure 2 - 64 Strain Pipe 3 – Section 1 .....	63
Figure 2 - 65 Strain Pipe 3 – Section 2 .....	63
Figure 2 - 66 Strain Pipe 3 – Section 1 .....	64
Figure 2 - 67 Strain Pipe 3 – Section 2 .....	64
Figure 2 - 68 Strain Pipe 3 – Section 1 .....	65
Figure 2 - 69 Strain Pipe 3 – Section 2 .....	65

Figure 2 - 70 Monitoring Strain Pipe 3 – Section 1 .....	66
Figure 2 - 71 Monitoring Strain Pipe 3 – Section 2 .....	66
Figure 3 - 1 Geometry of the finite element model .....	68
Figure 3 - 2 Finite Element Boundary Conditions .....	69
Figure 3 - 3 Trench soil and installation profile .....	72
Figure 3 - 4 Nodes shared between active and deactivated parts .....	74
Figure 3 - 5 Surface Contact Modeling .....	75
Figure 3 - 6 Pipe 1 Deflection: FEM vs. Field Test .....	76
Figure 3 - 8 Pipe 3 Deflection: FEM vs. Field Test .....	77
Figure 3 - 9 Pipe 1 Deflection: FEM Section 1 vs. FEM Section 2 .....	78
Figure 3 - 10 Pipe 2 Deflection: FEM Section 1 vs. FEM Section 2 .....	78
Figure 3 - 11 Pipe 3 Deflection: FEM Section 1 vs. FEM Section 2 .....	79
Figure 3 - 12 Pipe 1 Strains: FEM vs. Field Test .....	80
Figure 3 - 13 Pipe 2 Strains: FEM vs. Field Test .....	80
Figure 3 - 14 Pipe 3 Strains: FEM vs. Field Test .....	81
Figure 3 - 15 – Vertical displacement for a 108in diameter pipe .....	82
Figure 4 – 1 Pipe 1: Deformed Shape and Wall Stresses .....	86
Figure 4 – 2 Pipe 2: Deformed Shape and Wall Stresses .....	87
Figure 4 – 3 Pipe 3: Deformed Shape and Wall Stresses .....	89

List of Tables

Table 1 Types of pipes and current standards .....	2
Table 2 Values of Modulus of Soil Reaction (E') .....	13
Table 3 Staged construction for Pipe 1, Pipe 2, and Pipe 3 .....	34
Table 4 Construction Test Results .....	40
Table 5 Unconfined Compressive Strength Summary of the CLSM .....	40
Table 6 Steel Properties.....	71
Table 7 CLSM Properties.....	71
Table 8 Native Soil Properties .....	73

## Chapter 1

### Introduction, Literature Review, Goals and Scope

#### 1.1 Introduction

Pipelines are usually installed underground and serve to transport fluids. Large diameter pipes (larger than 24 in.) are widely used to transport water and wastewater, whereas small diameter pipes are used for drainage and transporting oil, gas, etc. The structural performance of pipes in buried pipelines depends on pipe and the properties of the soil surrounding the pipe. Buried pipes have to carry not only the internal pressure of the fluid but also external loads applied due to the soil backfill of the trench.

The structural design of buried pipes traditionally presents the following sequence: resistance to the internal pressure, resistance to transportation and installation, resistance to external loads, and longitudinal stresses and deflections.

The different methods for structural design of pipes depend on the pipe material. Certain types of pipes perform better under different conditions. Some pipe materials are better for internal pressure, other pipe materials perform better for external loads, and others are optimized cost.

Depending on the material selected, different methods for pipe structural design are applied. For design method and installation purposes, a pipe is considered rigid or flexible. According to Howard (1996), stress is created in the rigid pipe wall due to internal pressure, and strength is the capability of a pipe to withstand backfill load, live load, and longitudinal bending. Stiffness is the ability of a flexible pipe to resist deflection (in flexible design the soil provides 95% of the design stiffness required). Performance limits for stress and deflection are defined by standards for all different types of pipes. Table 1 presents typical pipe materials and their design methods, as well as the current standards used in the United States.

Table 1 Types of pipes and current standards

Pipe Material	Design Method	U.S. Standard
Reinforced Concrete	Rigid Wall Design	AWWA C302, ASTM C361, ASTM C655, ASCE 15-98, ASTM C301
Vitrified Clay	Rigid Wall Design	ASTM C700
Prestressed Cylinder	Rigid Wall Design	AWWA C301
Bar-wrapped Concrete Cylinder	Rigid Wall Design	AWWA C303
Steel	Flexible Wall Design	AWWA C200, M11
Ductile Iron	Flexible Wall Design	ANSI C151, AWWA A21.51
Corrugated Steel	Flexible Wall Design	ASTM A798
Polyvinyl Chloride	Flexible Wall Design	AWWA C901, C906
Polyethylene	Flexible Wall Design	ASTM F714, D3035
Fiberglass Reinforced	Flexible Wall Design	ASTM D3754

The design of buried pipes is the analysis of forces and their effects on materials, explains Watkins et al. (1999), and depending on the pipe material and its properties the structural analysis should also change to accommodate different material responses. The effect of force on material is deformation, force per unit area is stress, and the deformation per unit length is strain. The stresses and strains should not exceed the performance limits. For buried pipes, performance limits are usually related to deformations like: buckling, collapsing, cracking, as well as excessive deflection.

As described by Watkins et al. (1999) the two main analyses for buried pipes are longitudinal analysis and ring analysis. For the longitudinal analysis the two main analysis are axial and the longitudinal effect of beam bending. Longitudinally, changes in temperature and pressure can cause the pipe to lengthen or shorten. Non-uniform settlement of the bedding, soil creep or landslide, and hard points in the bedding are

usually the cause of flexural stresses of beam bending. Axial forces usually occur at pipe fittings, like elbows, tees, etc. where there is a change in the flow direction.

Reinforced concrete and prestressed concrete cylinder pipes are considered rigid pipes. On the other hand, steel pipes, ductile iron, polyvinyl chloride (PVC), and high-density polyethylene (HDPE) are flexible pipes. In between, are bar wrapped concrete cylinder pipes which are classified as semi-rigid pipe. The rigid pipes are designed to account for all stresses from both internal and external loads. Flexible pipe design is only designed for internal pressure and handling since, the external load capacity is fully dependent on side fill support. The stiffer the ring, the greater are the pressure concentrations on top and bottom, Watkins, (2009).

For rigid pipes hoop compression is defined as thrust (N). Thrust is a resultant component of moment which acts tangentially to the central perimeter of a curvilinear element, such as a pipe wall. The practical effect of the appearance of thrust in the wall of a rigid circular pipe is to increase the moment capacity for a given wall section as in a beam-column situation. According to the Concrete Pipe Technology Handbook of the American Concrete Pipe Association (2001), the concrete pipe wall must be designed to resist the combined effects of moment and thrust at the sections of maximum flexural stress with tension on the inside of the pipe (at the invert and crown), and at the sections of maximum flexural stress with tension on the outside of the pipe (usually near the spring line). Flexural stresses are produced by the combined effect of moment and thrust. Figure 1-1 shows the moments and forces at spring line and at the crown and invert of a rigid concrete pipe, as well as the cracking propagation of a concrete rigid pipe.



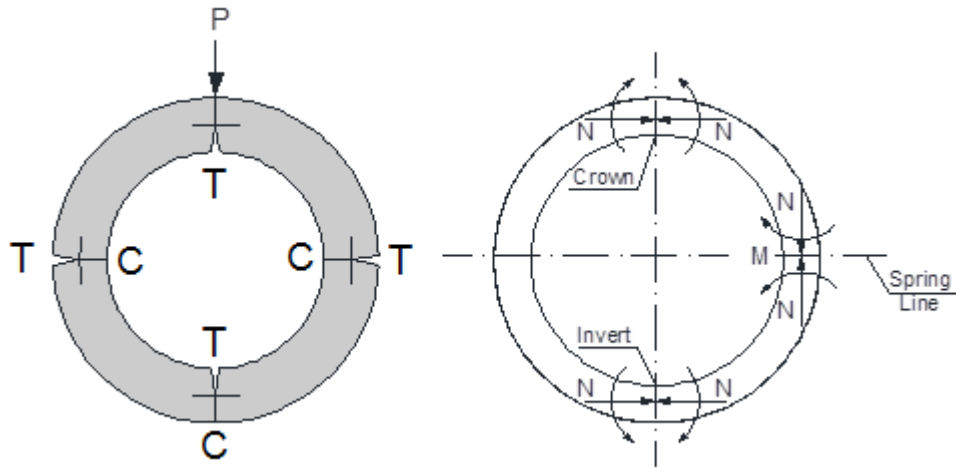

Figure 1- 1 Moments and thrust forces in a rigid concrete pipe

The ring analysis considers stress, strain, and deformation of the cross section. Depending on the pipe material, the ring can be rigid or flexible which presents different behavior and needs to be analyzed separately. The ring analysis stress verifies the performance limits in terms of stress at the point of excessive deformation. When internal or external pressure is applied in the pipe a stress is produced in the wall, as showed in the Figure 1-2 and Figure 1-3.

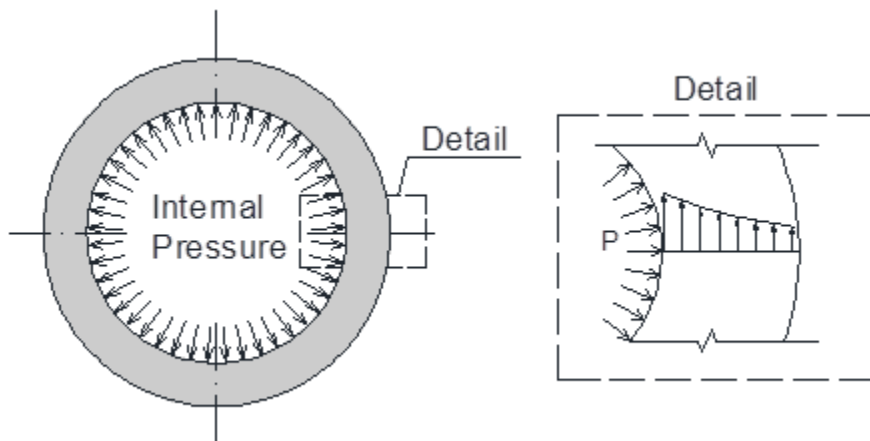

Figure 1- 2 Stress distribution across the wall of due to internal pressure

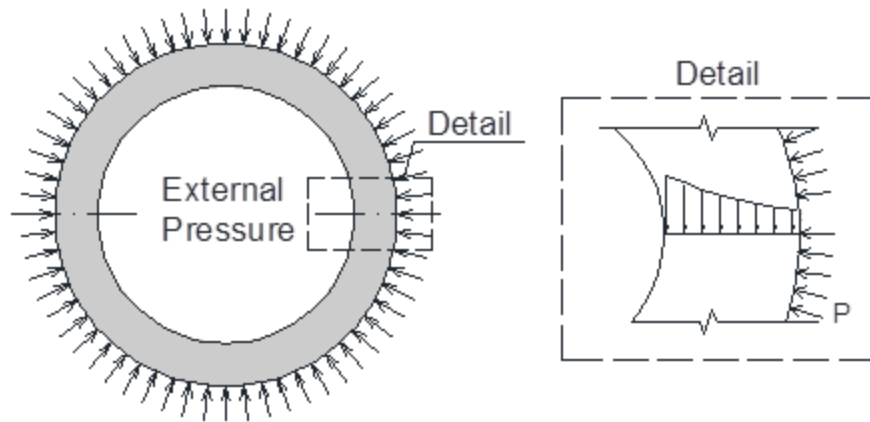

Figure 1- 3 Stress distribution across the wall of due to external pressure

For flexible pipes these stresses are known as hoop stresses. Hoop stresses can be pure tension due to internal pressure or compression due to external loads. As stated in the ASCE Buried Flexible Steel Pipe Design and Structural Analysis (2009) for external loads the performance limit for pipes is wall buckling at yield stress ( $\sigma_y$ ) divided by factor of safety. Although yielding in steel is not necessarily a failure condition, it is a conservative limit for the performance. The stresses in the steel pipe wall are explained in the Figure 1-4. Watkins (2009), states that vertically compressible fills causes concentrations of pressures on the top and bottom of the pipe. For flexible pipes the side fill walls support the loads applied on the pipe. When the pipe deflects vertically downwards, the horizontal diameter increases and triggers lateral soil pressure, consequently the load-carrying capacity increases. The decrease of the vertical diameter relieves the load by arching action over the pipe. The soil provides the resistance to ring deflection; therefore, the ring deflection is controlled by the soil stiffness. For any pipe stiffness, the ring is able to support part of the vertical loads. For flexible pipes the ring deflection is an important performance limit.

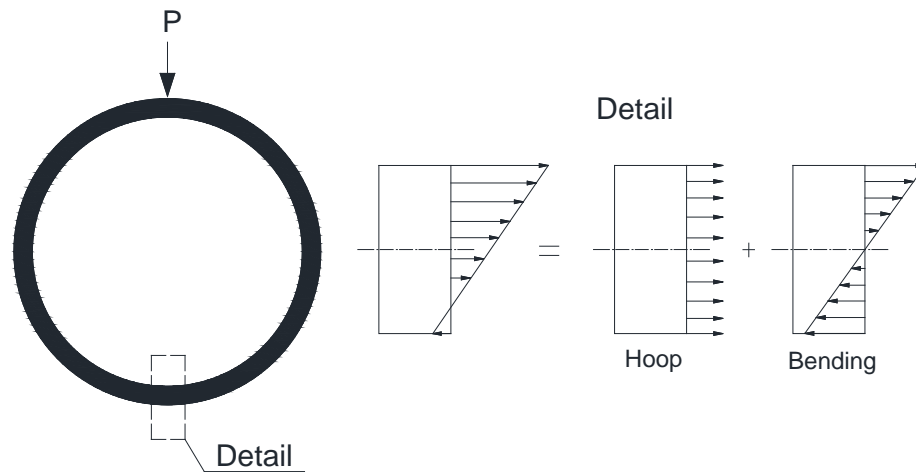

Figure 1- 4 Stresses at the bottom of a flexible pipe

### 1.1.1 Buried Steel Pipe Mechanics – Soil Properties

The deflection of the pipe depends on a combination of pipe stiffness and soil stiffness; however the soil stiffness provides most of the resistance to buried flexible steel pipe deflection. Watkins et al. (1999) explains that if the embedment of a buried pipe is densely compacted, vertical soil pressure at the top of the pipe is reduced by arching action of the soil over the pipe, like a masonry arch, that helps to support the load. The pipe stiffness is important during shipping and handling to keep the circular pipe shape and also during different construction stages.

Failure of buried pipes is generally associated with failure of the soil in which the pipe is buried. Basic principles of soil stresses and soil failure are important for understanding the structural behavior of buried pipes. Soil specifications are based on the mechanical properties and on the performance limits of soil (conditions for failure). Important soil performance limits in the pipe-soil interaction are: excessive compression and soil slip. For soil slip (shearing of soil on a slip plane) the two-dimensional Mohr circle (shear-strength soil model) is useful for analysis.

Tangents to a series of Mohr circles plotted from shear strength data are called strength envelopes. Shear strength circles are plotted from laboratory tests to failure. See Figure 1-5 based on Watkins et al. (1999), for illustration of the shearing stress as a function of normal stress and also the strength envelopes tangent to the Mohr circles.

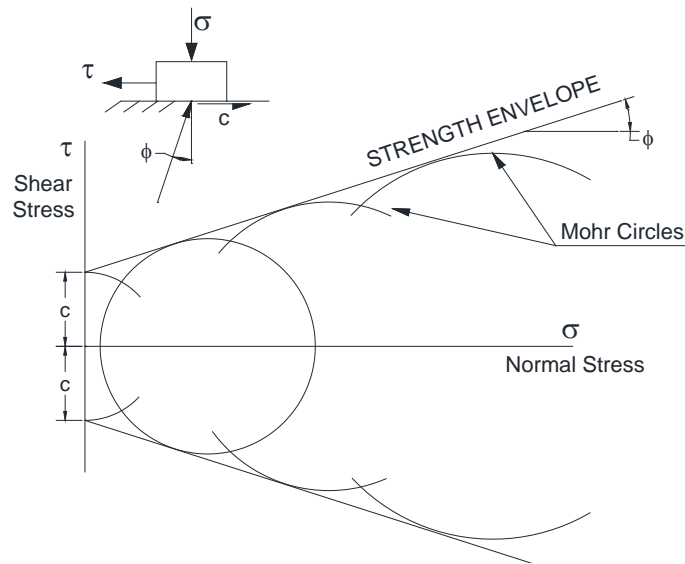

Figure 1- 5 Series of Mohr circles at soil slip and the strength envelope

Watkins et al. (1999) describes that after the soil strength envelopes are drawn with a series of Mohr circles, the stresses at soil slip are analyzed. Illustrated on Figure 1-5 is a soil with cohesion and friction. Analyzing the soil strength envelope, if the normal and shearing stresses applied on the soil plane falls between the strength envelopes soil does not slip on that plane. Cohesion is the shear stress axis intercept,  $c$ . Even at zero normal stress the glue offers resistance to shearing stress. But the shear strength is also related to the frictional resistance, which is  $\sigma \cdot tg\phi$ .

$$\tau = c + \sigma \cdot tg\phi \quad (1.1)$$

Where,

$\tau$  = Shear strength

$c$  = Cohesion

$\varphi$  = Angle of friction

$\sigma$  = Normal stress

The shear strength equation depends on the cohesion and angle of friction of the soil. Cohesion is shear strength, which allows the soil to maintain its shape under load, even if is not confined. Cohesion occurs as a result of very small particle size, which results in extremely low permeability. For example, clays are cohesive while sands and gravels are non-cohesive.

The angle of internal friction ( $\Phi$ ) is small when grains are smooth, coarse or rounded, and high for sticky, sharp, irregular or very fine particles. The friction angle is the angle of the failure plane. The embedment around the pipe is very important for pipe support, and is usually cohesionless soil like sand and gravel, depending specifically on local soil or available material resources for the pipeline project.

The unconfined compression strength is defined as the compressive stress at which an unconfined specimen will fail in a compression test, as described per ASTM D2166 Standard Test Method for UCS of Cohesive Soil.

$$UCS = Cu/2 \quad (1.2)$$

Where,

$UCS$  = unconfined compressive strength

$Cu$  = undrained cohesion

When designing flexible pipes, soil compression is related to soil strain and this length change can cause the pipe to shift and deflect as described by the ASCE Buried Flexible Steel Pipe (2009). The Young's Modulus is commonly used in the assessment of

soil settlement, and defines the basic stiffness modulus of the soil in an elastic model. The modulus of elasticity is well documented for several types of soil and can be determined based on empirical, laboratory test results, and results of field tests (CPT, SPT, etc.).

### *1.1.2 Controlled Low Strength Material*

The ideal and most economical installation is a narrow trench that permits the correct placement of the embedment in the haunch areas and around the pipe. Controlled Low Strength Material (CLSM) is commonly used in narrow trenches as embedment, improving the side support for the pipe without requiring a wide trench excavation, or where compaction of embedment is unsuitable.

Controlled Low Strength Material is a self-compacting, low-strength material used commonly used as embedment and as backfill. It is a mixture of Portland cement, soil and water; also fly ash and other recycled materials can be used. Different material properties can be achieved by changing the proportion of cement, water and soil, Zhan (1997). The CLSM usually is characterized by 50 to 100 psi strength, permitting the material to be excavated for future maintenance of the pipes. According to Nataraja (2008), flowable fills have very high workability, low density and low strength, which allow self-compaction. CLSM offers low settlement and usually has strengths greater than strength of local soils where the pipe is buried. Figure 1-6 is the comparison found on ASCE Buried Flexible Steel Pipe Design and Structural Analysis (2009) and demonstrates the increase in the compressive strength of plain granular soil and the same granular soil adding cement, where  $\sigma_c$  increases from 30 psi to 100 psi.

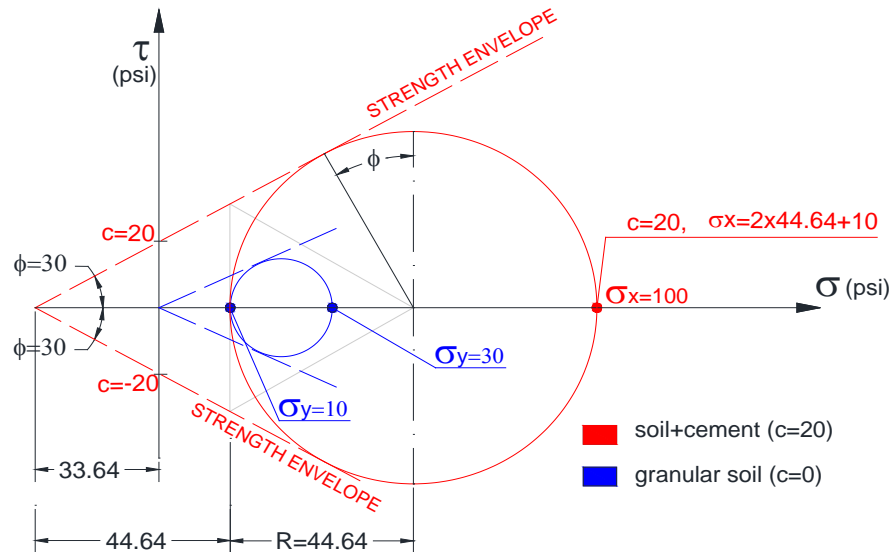

Figure 1- 6 Comparison of embedment with and without Portland cement from ASCE Buried Flexible Steel Pipe (2009)

Several standard test methods described and serve as guidelines for using CLSM. The ability to flow and consolidate with minimal effort is one advantage of CLSM over compacted granular fill. Flowability is one of CLSM most important properties and is related to the proper placement of the material around the pipe. A field test of buried pipes using CLSM as embedment was done by Webb (1998) to study installation practices. The pipes were re-excavated three weeks after the CLSM casting showing that the CLSM provided excellent support underneath the pipe at the haunches.

To test the CLSM flowability, as described by ASTM D 6103, a process similar to the slump test is used. The spread diameter is measured after a 3 by 6 in. tube that is filled with CLSM is lifted off a plan surface. The standard slump cone ASTM C 143 can also be used with CLSM, using the cone inverted. Typical CLSM values for the slump cone are described in ACI 229R-99.

Another important property of the CLSM is the compressive strength. For use of CLSM in pipelines trenches as embedment or backfilling, the compressive strength should be kept below 200 psi for mechanical excavation or below 50 psi for manual excavation. ASTM D 4832 describes the compressive strength test. The compressive strength test uses 3 in. by 6 in. or 6 in. by 12 in. cylinders for molding the specimens and the load is applied at a constant rate. When strain gauges are added to the test specimen, to record the displacement of the cylinder during loading, the stress-strain plot of the material specimen can be determined. The slope of the stress-strain plot is the material modulus of elasticity.

Hardening time is also a critical parameter to determine when the CLSM has hardened for the construction of the trench, such as subsequent soil layers or trench backfill, to proceed. The ASTM C 403 describes the penetration resistance test and ASTM D 6024 the ball drop test.

### *1.1.3 Current Steel Pipe Design*

In flexible steel pipe design, internal and external loads are analyzed independently and follow three basic steps as described by the ASCE Buried Flexible Steel Pipe (2009). The first step in buried pipe design is to determine the wall thickness required for internal pressure; second is to check if the wall thickness is sufficient stiff for shipping and handling; at last the depending on pipe embedment the maximum external loads are determined.

The AWWA Manual M11 (2004) describes the wall thickness design of the steel cylinder ( $t$ ), depending on the internal design pressure, and limiting steel stresses due to internal pressure.

$$t = \frac{pd}{2s} \quad (1.3)$$



Where,

$s$  = stress internal pressure, psi, for  $P_{\text{WORKING}}$  ( $s = 0.5\sigma_y$ ) for  $P_{\text{SURGE}}$  ( $s = 0.75\sigma_y$ )

$p$  = internal design pressure, working pressure ( $P_w$ ) or surge pressure ( $P_s$ ), psi

$d$  = outside diameter, in

$t$  = minimum pipe wall thickness for the specified internal pressure, in

The design of the minimum wall thickness for handling is based on three following equations:

$$\text{For pipe sizes I.D. up to 54in: } t = \frac{D}{288} \quad (1.4)$$

$$\text{For pipe sizes I.D. greater than 54in: } t = \frac{D+20}{400} \quad (1.5)$$

$$\text{For mortar-lined and flexible coated steel pipe: } t = \frac{D}{240} \quad (1.6)$$

For external loads, earth load and live load, it is required to limit the pipe deflection. The pipe deflection ( $Dx$ ) is predicted by the ratio of load to pipe-soil stiffness.

$$\text{Deflection} = \frac{\text{LOAD}}{\text{PIPE STIFFNESS} + \text{SOIL STIFFNESS}} \quad (1.7)$$

$$Dx = Dl \frac{KWr^3}{EI + 0.061Er^3} \quad (1.8)$$

Where,

$Dx$  = horizontal deflection of pipe, in

$Dl$  = deflection leg factor (1-1.5)

$K$  = bedding constant (0.1)

$r$  = radius, in

$E$  = modulus of elasticity (30,000,000 psi for steel)

$I$  = transverse moment of inertia per unit length of individual pipe wall

components  $t^3/12$ ,  $t$  (in)

$E'$  = modulus of soil reaction, psi

The modulus of soil reaction ( $E'$ ) is defined as a value that indicates the stiffness of the embedment soil. It is an empirical value and was introduced in the Modified Iowa Formula. Soil tests to determine the modulus of soil stiffness were performed by the U.S. of Bureau of Reclamation (USBR) for a variety of soils at different compaction levels and the USBR equation for predicting flexible pipe deflection was developed. The Table 2 shows the values of  $E'$  based on the depth of cover based on Hartley (1987), depending on the soil classification and compaction density. It is important to state that the modulus of soil reaction is not a material property and cannot be determined by soil sample tests.

Table 2 Values of Modulus of Soil Reaction ( $E'$ )

SOIL TYPE	AASHTO Relative Compaction 95%				AASHTO Relative Compaction 100%			
	Depth (ft)				Depth (ft)			
	2 to 5	5 to 10	10 to 15	15 to 20	2 to 5	5 to 10	10 to 15	15 to 20
<b>Fined-Grained soils with less than 25% sand content (CL, ML, CL-ML)</b>	1,000 psi	1,400 psi	1,600 psi	1,800 psi	1,500 psi	2,000 psi	2,300 psi	2,600 psi
<b>Coarse-grained soils with fines (SM, SC)</b>	1,200 psi	1,800 psi	2,100 psi	2,400 psi	1,900 psi	2,700 psi	3,200 psi	3,700 psi
<b>Coarse-grained soils with little or no fines (SP, SM, GP, GW)</b>	1,600 psi	2,200 psi	2,400 psi	2,500 psi	2,500 psi	3,300 psi	3,600 psi	3,800 psi

Howard (2006) reevaluates the values of the modulus of soil reaction. The 2006  $E'$  values are based on vertical deflections, instead of horizontal deflections used in the previously studies. The soil classification is also revised. In this study, Howard proposed three increases of  $E'$  values for high degree of compaction >95% in clean sands (GW, GP, SW, and SP), clays and silts (CL, and ML), and sands and gravel (GC, GM, SC, and SM). Also one  $E'$  increase in the dumped sands and gravel and for compacted crushed rock. A decrease for slightly compacted sands and gravels is also proposed.

Another factor not incorporated in the design of flexible pipes is the consideration of soil stiffness of the trench wall. The use of a composite  $E'$  that depends of the trench wall soil was published in the AWWA Fiberglass Pipe Design Manual 45 (1996). This relationship was first addressed by Leonhardt (1978), and acknowledges that a narrow trench with an embedment of stiff soil next to a soft soil trench wall does not provide the same restraint as if was next to a stiff soil trench wall. Also, the composite  $E'$  presents a relation with the trench width and the diameter of the pipe.

Allowable pipe deflection for different steel pipe lining and coating are usually 2% of pipe diameter for Mortar-lined and coated; 3% of pipe diameter for Mortar-lined and flexible coated; and 5% of pipe diameter for Flexible lined and coated pipe.

In addition, live loads also need to be considered. Live load effect for steel pipes is based on ASSHTO HS-20 highway loads or Cooper E-80 railroad loads.

## 1.2 Justification of this Research

As discussed before, the latest American Water Works Association - AWWA M11 and C200 design standards for steel pipes, require the pipe to be designed for internal pressure and handling, then once the wall thickness is determined, the projected external load capacity is estimated based upon predicted deflection and available soil support. By AWWA M11, the available soil support is based on modulus of soil reaction ( $E'$ ), an empirical value that cannot be verified.

In flexible pipe design the performance of the pipe is evaluated by limiting the deflection. The soil provides 95% of the stiffness required for the pipe to resist to this deflection. Thus, an analysis of buried steel pipes, including field tests monitoring the pipe deflection and strain, and a finite element analysis modeling the pipe-soil interaction are extremely valuable to understand the performance of flexible pipes. Finite element

modeling is a powerful tool for predicting the deflection of steel pipes in different soil and trench conditions, such as in narrow trenches where CLSM is commonly used as bedding and embedment.

### 1.3 Field Test and Finite Element Modeling Background

There are several papers and researches published about buried pipes. Testing buried pipes, monitoring the pipe behavior in different trench conditions, is extremely valuable to predict the displacement of the pipe for long term and during construction stages. Many of these studies are complement to verification of finite element modeling.

Webb et al. (2006) research performed an extensive field test and buckling strength analysis of three buried large-diameter steel pipes to evaluate pipe-soil interaction during backfilling and to determine the buckling strength of the pipe. The horizontal and vertical deflections of the pipe shape were measured with a costume built profilometer, and photogrammetry was used to obtain detailed bucking deformations. The details of the testing and procedures are described in details in this study.

McGrath et al. (1999) conducted an extensive instrumentation to monitor buried pipe behavior, soil behavior and pipe-soil interaction during backfilling (including CLSM). Fourteen pipes with different materials and geometry were used (reinforced concrete, corrugated steel and corrugated HDPE) with outside diameter of 35in and 60 in. The test used profilometer to detect pipe deflections and distortions and resistance, and strain gages to detect structural deformations, moments, and axial forces in the pipe wall; other instruments were used to measure the pipe-soil interactions and soil loads. The procedure for placing the strain gages and displacement transducers are described and the equipment achieved the proposed data acquisition for the experiment in several stages of the test.

The research of Kawabata et al. (2006), also managed the use of displacement transducers and strain gages in the field instrumentation of buried pipes. There are two main researches that are pertinent to the topic of this thesis. First, the field test monitoring the behavior of buried flexible pipe under high fills. The pipes are fiberglass reinforced plastic mortar (FRPM) with 35in diameter, and are under 155 ft. of surcharge load. Deflection and strains in the pipe were successfully recorded and a comparison of the experimental results and the modified Spangler's method is also included. Another research guided for Kawabata et al. 2006, is the field test for buried steel pipes with thin wall. In this study, steel pipes with 138 in. diameter and 1 in. thickness are monitored and CLSM is used as embedment (up to 0.5 and 0.25 of the pipe diameter). The deflections and strains of the pipe were highly influenced by the stiffness of the embedment soil, as expected for flexible design. However, the flexible pipe theory proposed by Marston-Spangler bears the external force with the deformation of the whole pipe; this study observed local deformation showing that the Marston-Spangler design theory may not be appropriated.

Finite element modeling has been commonly used in analyses of buried pipes. Dezfooli et al. (2013) performed a three dimensional finite element analysis based on experimental soil box test using steel pipes. The full-scale soil box test reproduced staged construction where two tests were performed; first, the test was performed using pea gravel for bedding and native soil for backfilling; second, the bedding material was lime treated native soil and backfill material was native soil. All the stages of construction are reproduced in the finite element model accounting the different geometry, soil properties, soil contacts, and loads. The loads are self-weight, lateral soil forces at-rest and compaction forces. The model predicted successfully the horizontal and vertical

displacements of the steel pipe during staged construction. The laboratory soil box test is described in the study conducted by Sharma et al. (2011).

Zhan et al. (1997) conducted a finite element analysis to validate the observed response of a shallow PVC and ductile iron pipe subjected to dead and live loads. The trench configurations of the modeling reproduce those at the test site and uses native clay, sand and flowable fill. The two dimensional finite element modeled the soil properties, interactions and loads (including the traffic load). The large difference observed in the comparison of finite element and field data when using the CLSM are mainly due to the two dimensional plane strain analysis, in lieu of the three dimensional problem.

The study carried out by Cho et al. (2004) investigates the behavior of flexible PVC pipe with sand as backfill material and verifies the test results with finite element modeling. The finite element is modeled using the program Plaxis, and investigates the influence of different backfill parameters on the vertical displacement of the pipe.

#### 1.4 Goals and Scope

The objective of this research is to evaluate the performance of steel pipes coupled with Controlled Low Strength Material (CLSM).

The current research is part of an extensive study on selected steel pipes and evaluates the performance of steel pipes using CLSM for the Integrated Pipeline project (IPL). The study includes experimental field test and a finite element analysis modeling the pipe and the trench staged construction.

A nonlinear three dimensional finite element model for steel pipes coupled with CLSM is developed and is capable to simulate the performance of steel pipes under different trench conditions. The model analyzes and reproduces the important pipe-soil stiffness system, modeling contact surfaces and soil properties. Also, it includes the

analysis of the trench wall soil and recognizes that a narrow trench with an embedment of stiff soil adjacent to a soft soil trench wall does not provide the same restraint as if was adjacent to a stiff soil trench wall. The finite element model take into consideration embedment compaction forces that are calibrated based on previously research of buried pipe soil box test conducted at UTA Civil Engineering Laboratory (Dezfooli, 2013).

The field test is performed acquiring the pipe performance during its trench installation in a non-controlled environment, reproducing the field construction of the pipeline. The field test consists to monitor the behavior of 3 buried steel pipes (outside diameter of 84 in.) in different trench soil conditions using CLSM. Installation variables including in situ soil conditions, trench widths, and backfill material and compaction methods are part of the test. The field test is important to verify the finite element model developed, and record data including the adjacent soil of the trench wall. Therefore, the compaction forces on the pipe, previously recorded in the soil box test, can be verified.

Then, finite element model can be used to predict the performance of steel pipes in different trench conditions.

Based on design criteria, steel pipes are required to perform under the allowable stress (respecting yielding limit state), and under vertical and horizontal deflection (usually 2% of the steel pipe diameter). Thus, steel pipes should be design to satisfy these required performance limits. As discussed before, the soil provides the stiffness for flexible pipe design. For this reason, preferable trench conditions, such as, trench geometry, and type of soil used for bedding and embedment can be selected.

## Chapter 2

### Field Test

#### 2.1 Introduction

Field test of buried pipes, monitoring the pipe in different trench conditions, is remarkably valuable in predicting pipe displacement. The field test consists to monitor the performance of three buried steel pipes (outside diameter of 84 in. and 0.375 in. thickness) in different trench soil conditions using CLSM. Installation variables including in situ soil conditions, trench widths, and backfill material and compaction methods are part of the test. The field test is important to verify the finite element model developed, and record the buried pipe performance including the soil stiffness of the adjacent trench wall.

The field test monitors the circular displacements and strains of a buried steel pipe in three different trench profiles using controlled low strength material. For the first case, the trench width is 120 in., and CLSM is used as embedment up to 30% of the O.D. In the second case, the trench width is also 120 in., and CLSM is used as embedment up to 70% of the O.D. In the third case, the trench width is 102 in., and CSLM is used as embedment up to 70% of the O.D. From the CLSM to the top of the pipe, ordinary local soil is used and compacted. Also, five feet of backfilling soil is added for all cases.

For pipe structural monitoring, strain gages are attached inside and outside of the pipe to obtain the circumferential strain, and displacement transducers are installed to record both vertical and horizontal diameter displacement.

The field test installation can be divided in three distinctive phases: trench excavation and pipe and manholes placement, permanently embedment of the pipe, and backfilling of the trench.



The field test is performed acquiring the pipe performance during its trench installation in a non-controlled environment, reproducing the field construction of the pipeline. The pipes are located in Fort Worth, Texas at a property of TRWD. The deflections of the steel pipes are measured in each of the construction stages: the CLSM embedment, the soil compaction, and during the load of the 5 ft. soil on top of the pipe.

## 2.2 Field Test Overview

The field test monitors the circular displacements and strains of a buried steel pipe with an outside diameter (O.D.) of 84 in. and 0.375 in. thickness in three different trench profiles using controlled low strength material. For the first pipe, the trench width is the O.D. plus 36 in., and CLSM is used as embedment up to 30% of the O.D. In the second pipe, the trench width is the O.D. plus 36 in., and CLSM is used as embedment up to 70% of the O.D. In the third pipe, the trench width is O.D. plus 18 in., and CSLM is used as embedment up to 70% of the O.D. From the CLSM to the top of the pipe, ordinary local soil is used and compacted to 95% standard proctor density. Also, an approximately five feet of backfilling is added for all cases. For pipe structural monitoring, strain gages are attached inside and outside of the pipe to obtain the circumferential strain, and displacement transducers are installed to record both vertical and horizontal diameter displacement. Figure 2-1 illustrates the three trench profiles described above.

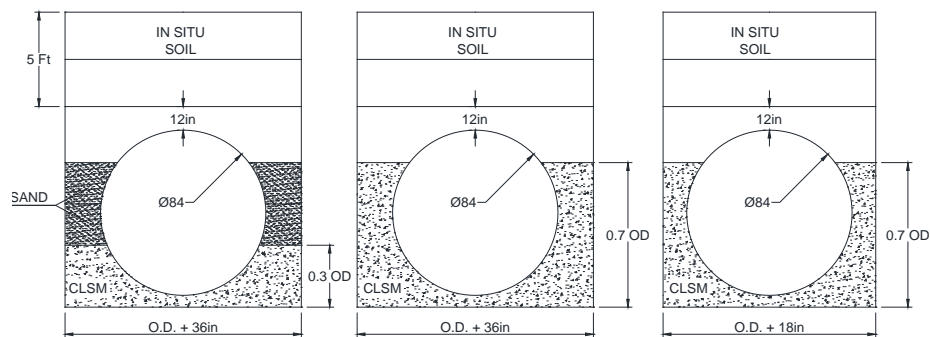

Figure 2 - 1 Trench profile for Pipe1, Pipe2 and Pipe3

The overview of the field test is illustrated in the Figure 2-2. Pipe-1, Pipe-2 and Pipe-3 are instrumented at one thirds of the pipe's total length. The cross sections of the pipes instrumented are called section 1 and 2. Each section has 10 data acquisition channels. Each section of the pipes has eight strain gauges (seven inside of the pipe and one outside). The displacement transducers (DTs) are placed at the spring line for reading the displacements in the horizontal direction, and from the invert to the crown of the pipe for reading the displacement in the vertical direction. Each pipe has 20 channels, and the test has 60 channels total.

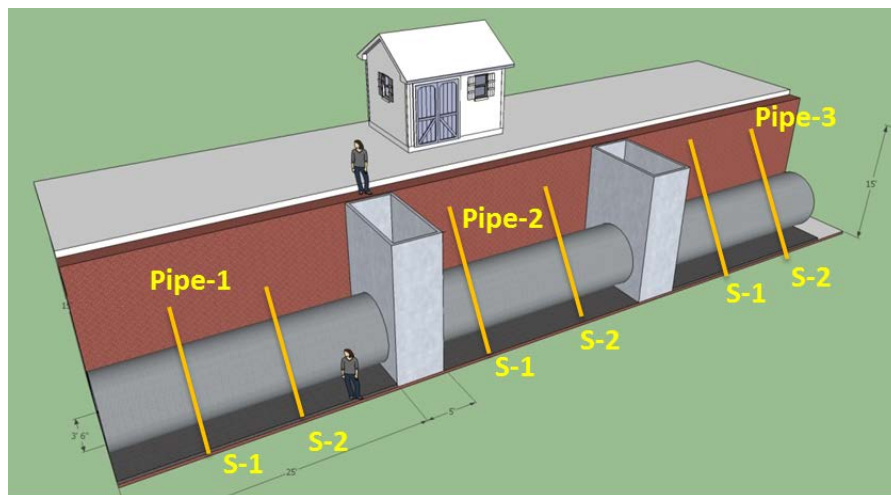

Figure 2 - 2 Field Test set up Overview

The pipes are connected by concrete vaults that permit inspection of the instrumentation during and after the field test. The strain gages and displacement transducers cables were extended around 60 ft., in order to reach the data acquisition shed. Each pipe has its own Vishay scanner and computer.

The channels 1 to 60 are illustrated on Figure 2-3 to Figure 2-5.

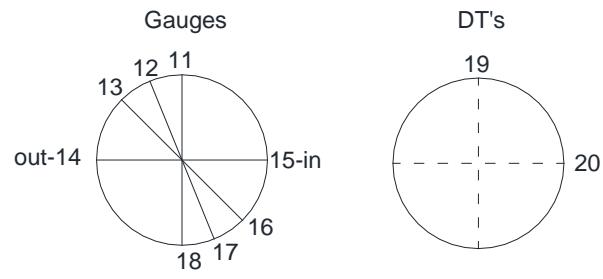
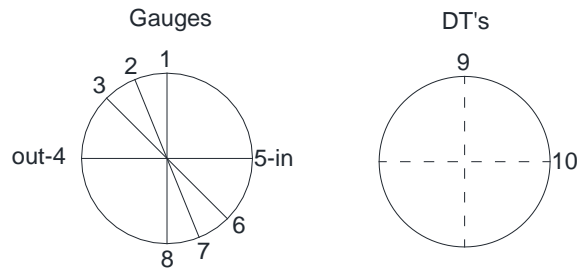

Figure 2 - 3 Pipe 1 - Section1 and Section2

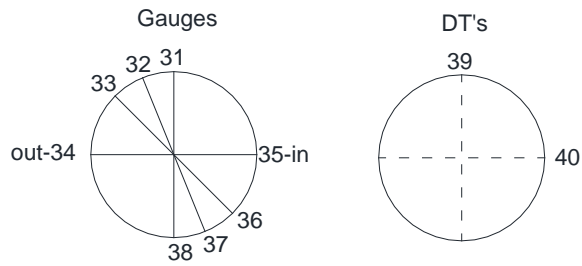
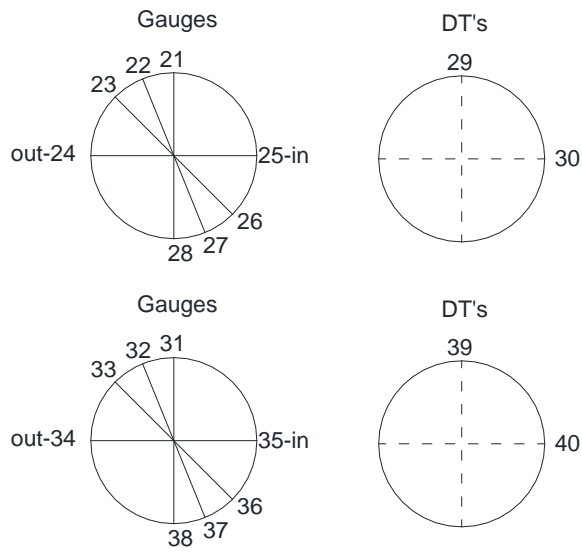

Figure 2 - 4 Pipe 2 – Section1 and Section2

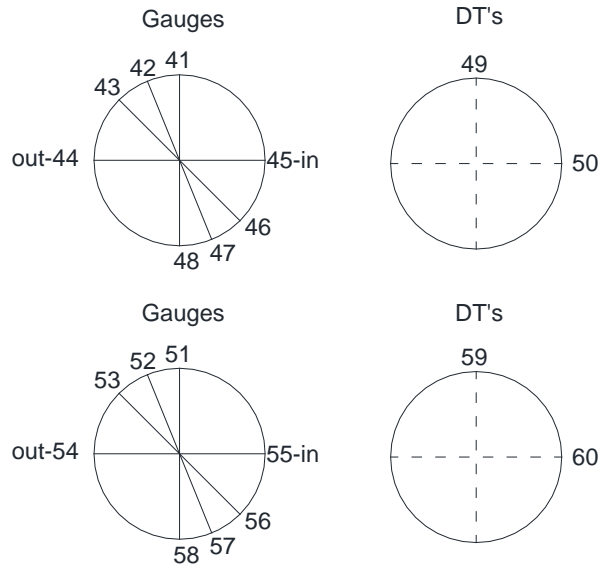

Figure 2 - 5 Pipe 3 - Section1 and Section2

### 2.3 Pipe Instrumentation

The field test consists in monitor the circular displacements and strains of three buried steel pipes. For pipe structural monitoring, strain gages are attached inside and outside of the pipe to obtain the circumferential strain. Displacement transducers are installed to record both vertical and horizontal diameter displacement.

Each pipe is instrumented in two sections at one third of the 25 ft. total length of the pipe. The sections locations are illustrated in the Figure 2-6.

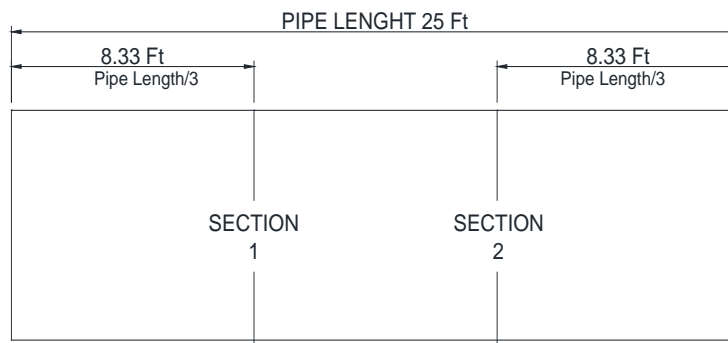

Figure 2 - 6 Instrumentation Section1 and Section 2

The position of the strain gauges and displacement transducers in the pipe cross section is showed in the Figure 2-7.

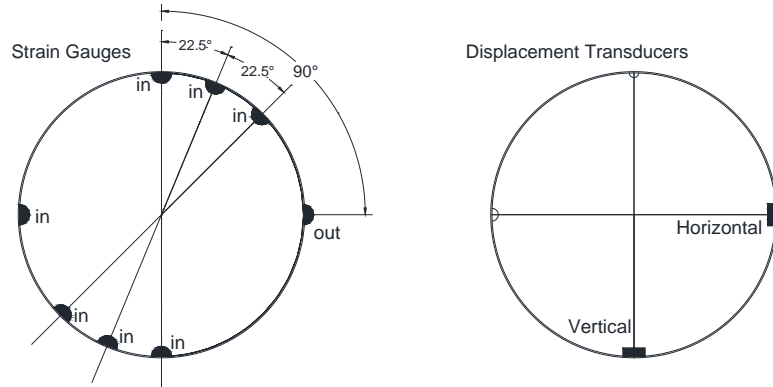

Figure 2 - 7 Position of the strain gauges and displacement transducers

The cable-extension displacement sensors (Figure 2-8) are Vishay Micro-Measurements Model CDS-20, and the sensor base and the end of the cable are glued to the pipe wall. The sensor measures the change in resistance as the steel cable extends and produces a voltage output that is proportional to the displacement. The base of the sensor was attached to the pipe wall and the other end of the cable was attached to the opposite pipe wall surface.

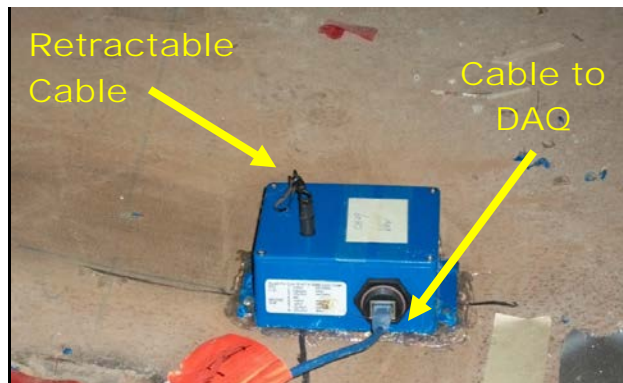

Figure 2 - 8 Displacement Transducer Sensor

For the strain monitoring, high quality precision general purpose strain gages – from Vishay are used. The gages are linear pattern encapsulate constantan with

preattached ready to use cables. The gage code C2A-06-250LW-350 refers to the gage series, S-T-C (self-temperature-compensated) number, gage length (0.250 in), gage pattern, and resistance (ohms).The strain gages are installed on the pipe wall following the manufacture's recommendations and accessories from Vishay Micro-Measurements that are compatible with the gages used.

At first, the surface of the pipe is manually prepared using sand paper to remove rust and imperfections.

For proper bonding of the strain gages, the pipe surface must be chemically clean and free of contaminants before applying the adhesive. The pipe surface is chemically cleaned using CSM-2 solvent degreaser to remove the oily contaminants. After the surface is oil clear, a water based cleaner M-Prep Conditioner-A MCA-1 is applied to accelerate the cleaning process, using cotton swabs. Immediately after the conditioner the surface Neutralizer ammonia-based MN5A-1 is applied to neutralize any chemical reaction introduced by the Conditioner A. Figure 2-9 illustrates the materials used for surface cleaning.



Figure 2 - 9 Surface chemical cleaning preparation

Following the surface preparation, the strain gauges are attached to the pipe wall using M-Bond 200 adhesive. The M-Bond 200 is a general purpose adhesive and is very easy to handle and cures after one minute thumb pressure, followed by a minimum two

minutes delay before tape removal. The criteria used for the proper selection of the adhesive are the gauge selection, test duration and operating temperature range.



Figure 2 - 10 Adhesive and protective coating

After the installation of the gages on the pipe wall, a protective M-Coat A general purpose transparent polyurethane thick coat is applied to reduce the effects of moisture, chemical attacks, or mechanical damage. The M-Coat A dries at room temperature in twenty minutes and is completely dry in two hours. Figure 2-10 shows the adhesive and protective coating product used. Finally, a water proofing tape is applied providing mechanical protection to the gage. Figure 2-11 shows the strain gage installed.

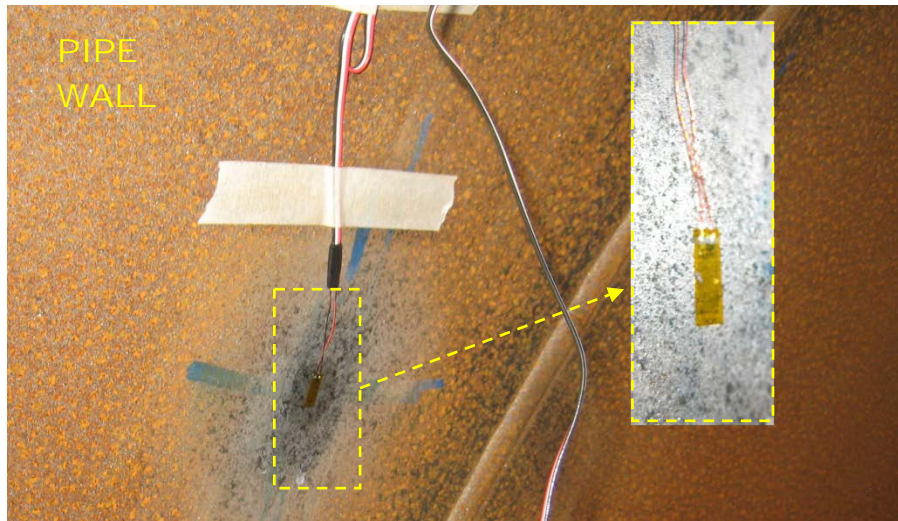

Figure 2 - 11 Strain gauge installed on the steel pipe wall

The strain gauges and displacement transducers are then connected to a signal processing and data acquisition unit (DAQ). The strain gauges and displacement sensors are wired into a wiring adaptor female-male, and these are connected directly to the data acquisition board—which is capable to provide the required excitation voltage. The data acquisition unit is a Vishay System 5000, Model 5100B Scanner (Figure 2-12). This is a high-performance, high-precision computer-based data acquisition system configured with Strain Smart software with the ability to read precision strain measurements. The 5100B version features current output capability, which is employed to power the strain bridges. For the setup of the Smart Strain software, the first step is defining the sensors by type, calibration values, and excitation voltage specific to each sensor. Finally, each channel is assigned to a specific sensor, and after defining the scan session and number of reported data per second, the software set up was complete. In this study, three Data Acquisition Units were used, one for each pipe. The data acquisition unit is shown in the figure 2-12.

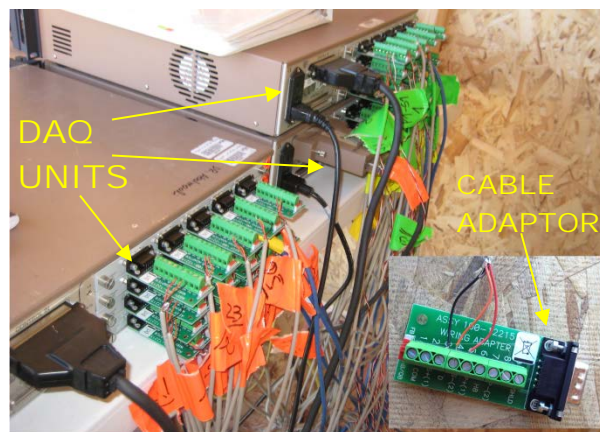

Figure 2 - 12 Data acquisition unit

#### 2.4 Field Test Installation – Trench Excavation and Pipe Laying

The three pipes were transported by truck to the field test on October, 23rd of 2012 when the trench excavation of the designated site started. To avoid excessive



deformations during shipment, internal bracings (also called struts) were installed by the manufacturer. Three struts were placed per section in two sections of each pipe, at approximately one third of the pipe length. The struts are essential to many pipes that have low stiffness like steel pipes, and it is recommended that their removal occur only after the embedment is completed.

The trench excavation width proposed for Pipe1 and Pipe2 is 120 in., and for Pipe3 is 102 in. The proposed trench width was excavated from the bottom of the trench to 1 ft. above the top of the pipe. From the top of the pipe the trench was excavated wider (approximately 18 ft.) for safety and workability reasons. Figure 2-13 illustrate the beginning of the excavation.

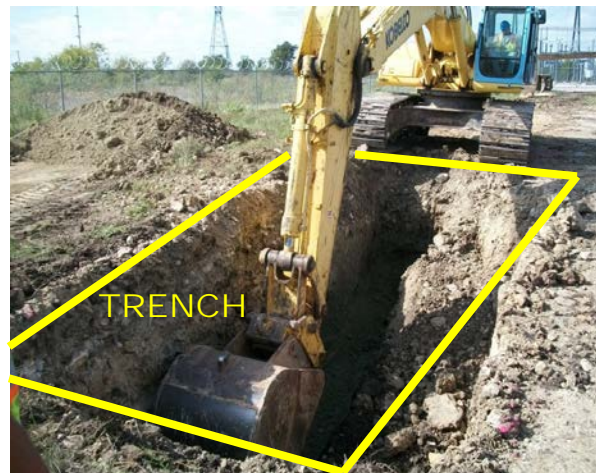

Figure 2 - 13 Trench excavation

Excavation safety is important when opening the trench and having workers in the trench to help installing large pipes. The trench opening requires the excavation of a large soil mass. Soil movement and slope failure depends of the internal properties of the soil that has been excavated. In practice, the vertical trench cut cannot be assumed absolutely safe. The Figure 2-14 shows the steel trench box that is designed to catch soil slips and protect the workers. The workers are required to go inside the trench to place

the sand bags. The sand bags lift the pipe 6 in. from the ground and later permit the CLSM to involve the pipe on haunch areas.

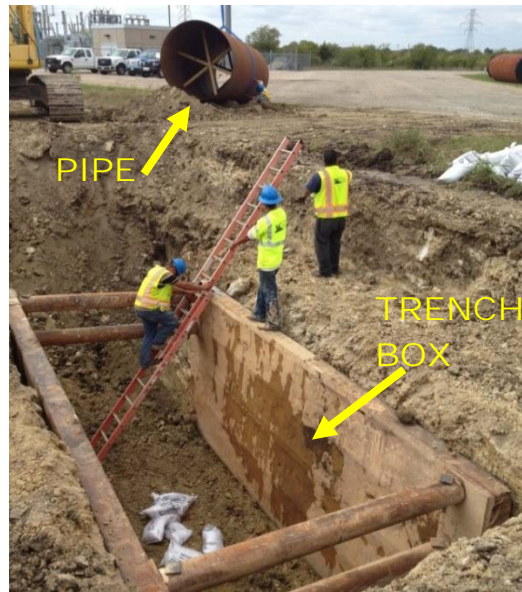

Figure 2 - 14 Steel trench box

The excavation and pipe laying follow the order: trench for Pipe1 and the first vault were excavated and the Pipe1 was placed. After that, the trench for accommodating pipe 2, second vault and Pipe3 were excavated and the Pipe2, second vault and Pipe3 were placed. As the final step of installation the vaults risers were placed. Figure 2-15 shows the pipes, vaults and risers installed.

With the pipes and vaults placed, the gap around the pipe at the connections with the vaults was filled with insulating foam sealant. On top of the sealant foam was applied a fine coat of pipe patch in order to mechanically protect the foam. The pipes ends were closed with plywood to avoid CLSM and soil entering inside the pipe. All the connections with the pipe are flexible and do not present any movement restraint. Figure 2-16 and Figure 2-17 show the pipe connection with the vaults and the closed pipe end.



Figure 2 - 15 Overview of the trench



Figure 2 - 16 Connection of the pipe and the vault



Figure 2 - 17 Pipe end closed with plywood

On October, 29<sup>th</sup> 2012 the final pipe instrumentation started, where all the strain gauges were checked and a few had to be replaced. The displacement transducers were attached to the pipe and the cables were extended to reach the data acquisition equipment. The Figure 2-18 shows the internal section of the pipe after final instrumentation; channels 1 to 8 represent the strain gauges and the channels 9 and 10 are the displacement transducers. Figure 2-18 presents the cables extensions and the path from the pipe to the DAQ system passing through the vaults.

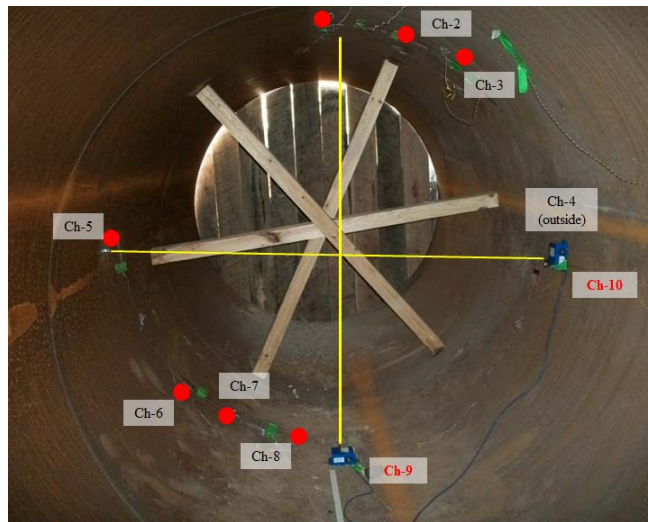

Figure 2 - 18 Pipe cross section of instrumentation



Figure 2 - 19 Concrete vault and cables path from the pipe to the DAQ headquarters

The Data Acquisition headquarter is shown in the Figure 2-20 and Figure 2-21.



Figure 2 - 20 Data acquisition headquarter

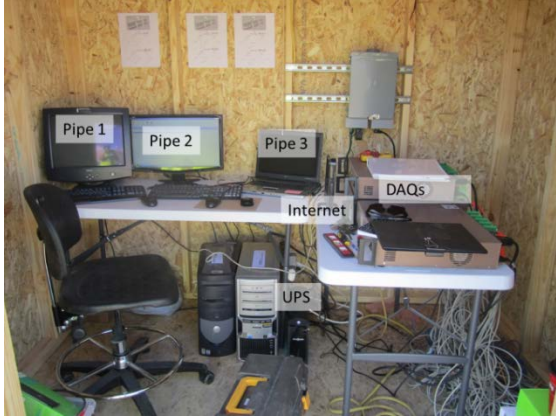

Figure 2 - 21 Data acquisition scanners connected to the computers

#### 2.4.1 Trench Geometry and Surveying of the Trench

To assure that the field test geometry of the trench is reproduced identically in the finite element model, a survey of the actual geometry of the field test was performed before and after the CLSM casting. The total station was used and the measurements were taken approximately at every 5 ft. Figure 2-22 illustrates the survey of the trench.

The proposed trench width for Pipe 1 is 120 in. The actual surveying width measured ranges from 119 in. to 125 in. For the Pipe 2, the trench width proposed is also 120 in. The actual width measured ranges from 123 in. to 211 in. The wider trench is observed closer to the vaults, where the construction contractor excavated the trench more than the trench width proposed in order to install the manholes. The proposed trench width for Pipe 3 is 102 in. The actual surveying width measured ranges from 105 in. to 156 in. closer to the vault.

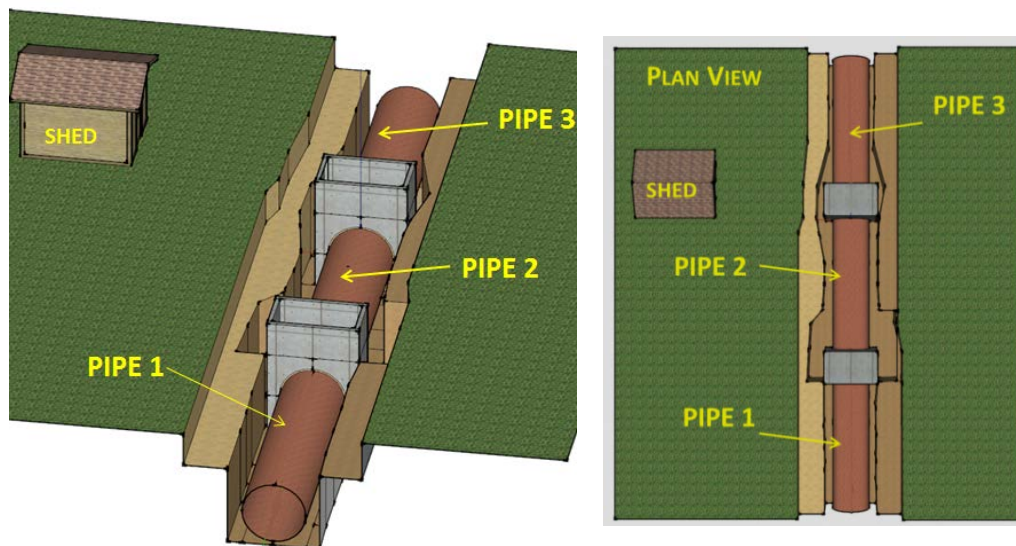

Figure 2 - 22 Field test geometry overview

## 2.5 Field Test Installation – Embedment and Staged Construction

The field test monitors the displacements and circumferential strains of three buried pipes during all the construction stages. The displacements and strains are read at each construction stage and then can be compared with the staged construction finite element modeling. The Table 3 shows the order and depths that the layers of the CLSM and soils that are added to the trench. More details in the geometry of the field test are given as follow.

Table 3 Staged construction for Pipe 1, Pipe 2, and Pipe 3

PIPE 1			PIPE 2			PIPE 3		
TIMELINE	LAYER	DEPTH	TIMELINE	LAYER	DEPTH	TIMELINE	LAYER	DEPTH
DAY1	CLSM 1	30% O.D.	DAY1	CLSM 1	30% O.D.	DAY1	CLSM 1	30% O.D.
DAY3	SAND 1	1 Ft	DAY2	CLSM 2	70% O.D.	DAY2	CLSM 2	70% O.D.
DAY3	SAND 2	1 Ft	DAY4	LOCAL SOIL COMPACTED	1 Ft	DAY3	LOCAL SOIL COMPACTED	1 Ft
DAY4	LOCAL SOIL COMPACTED	1 Ft	DAY4	LOCAL SOIL COMPACTED	1 Ft	DAY4	LOCAL SOIL COMPACTED	1 Ft
DAY4	LOCAL SOIL COMPACTED	1 Ft	DAY5	LOCAL SOIL BACKFILLING	3 Ft	DAY6	LOCAL SOIL BACKFILLING	3 Ft
DAY6	LOCAL SOIL BACKFILLING	3 Ft	DAY6	LOCAL SOIL BACKFILLING	3 Ft	DAY6	LOCAL SOIL BACKFILLING	3 Ft
DAY6	LOCAL SOIL BACKFILLING	3 Ft						

For the first pipe, the trench width is 122in, and CLSM is used as embedment up to 30% of the O.D. which is poured in one lift. Then sand is placed above the CLSM up to 70% O.D. in two lifts of approximately 12 inches each. From the top of the sand to one foot from the pipe's top, ordinary local soil is used and compacted to 95% standard proctor density. The ordinary soil is compacted in two lifts of 12 in. each. Also, two layers of 2.5 ft. each of local soil is added for all cases as backfilling. Figure 2-23 illustrates the trench configuration for Case1.

For the second pipe, the trench width is the 122in, and CLSM is used as embedment up to 70% of the O.D. The CLSM is poured in two lifts; the first lift is up to 30% of O.D. and the second up to 70% of O.D. From the CLSM to one foot from the pipe's top, ordinary local soil is used and compacted to 95% standard proctor density. The ordinary soil was compacted in two lifts of 12 in. each and the local soil was used as backfilling. Figure 2-24 illustrates the trench configuration for Case2.

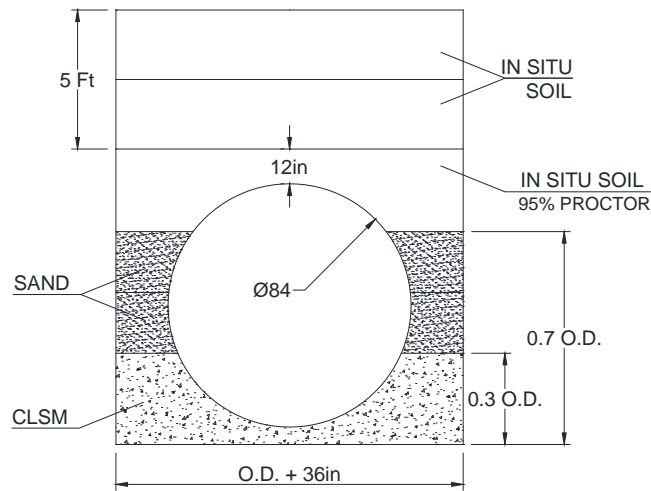

Figure 2 - 23 Schematics of the proposed trench configuration for Case 1

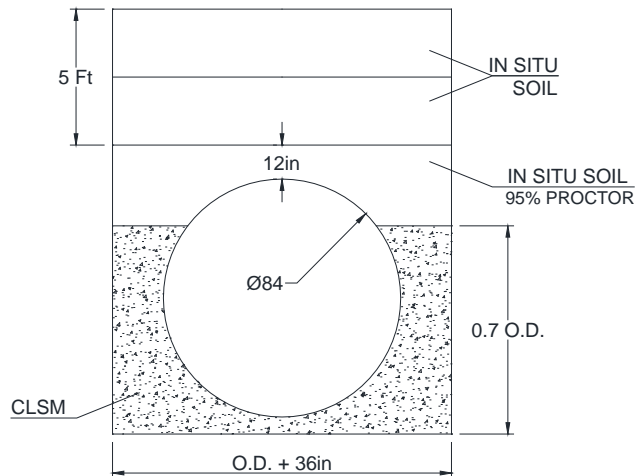

Figure 2 - 24 Schematics of the proposed trench configuration for Case 2



In the third pipe, the trench width is 102in, and CSLM is used as embedment up to 70% of the O.D. The CLSM is poured in two lifts; the first lift is up to 30% of O.D. and the second up to 70% of O.D. From the CLSM to one foot from the pipe's top, ordinary local soil is used and compacted to 95% standard proctor density. The ordinary soil was also compacted in two lifts of 12 in. each and the local soil was used as backfilling. Figure 2-25 illustrates the trench configuration for Case3.

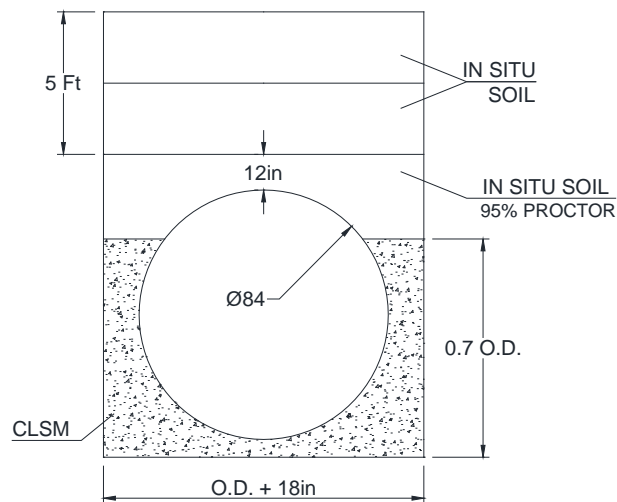

Figure 2 - 25 Schematics of the proposed trench configuration for Case 3

The three proposed trenches including geometry of the pipe and trench width, type of soils, strength and height of CLSM, are in the Integrated Pipeline Project Specifications Manual and simulate the field conditions that can occur in the actual pipeline project.

### 2.5.1 Controlled Low Strength Material Installation

Controlled Low Strength Material is a mixture of soil, cement, and water. The CLSM used in the field test was trench-side mixed. The soil used is the local soil

excavated from the trench. The soil is processed using the backhoe adapted to a soil shredder. The Figure 2-26 shows the backhoe shredder.

A trench-side traveling batch plant fully automated was used to prepare the CLSM and it is showed in the Figure 2-27. The batch mixed the shredded soil, 10% cement, and water and the mixture was inspected before poured into the trench. The CLSM at first appeared to be uniform and with a flowable consistency.



Figure 2 - 26 Soil shredder



Figure 2 - 27 Traveling batch plant

After the inspection, the CLSM was poured into the trench. The pipes were laid on sand bags to the proper grade level and the sand bags were also used in a manner to restrain the pipe from rolling.

The CLSM was poured in two lifts to avoid pipe flotation. The first lift is poured up to 30% pipe O.D. for all three pipes. Figure 2-28 shows the CLSM being casted. The first lift was casted on November, 5<sup>th</sup> 2012. The second lift up 70% O.D. was casted in the next day on Pipe2 and Pipe3, allowing the recommended hardening time.



Figure 2 - 28 CLSM placing overview

Placing the CLSM in two lifts was recommended to avoid flotation, although Pipe1 experienced floating of 1.5 ft. at the free end, consequently the pipe moved 11 in. inside the manhole. Figure 2-29 shows the pipe after flotation where the plywood also moved and allowed the CLSM to enter inside the pipe.



Figure 2 - 29 Pipe 1 after flotation

When casting the CLSM on pipe 1 the plywood also moved allowing a small quantity of CLSM entering the pipe. In both situations, the displacement transducers were

affected and the collected data had to be refined. The Figure 2-30 shows the CLSM inside the Pipe1.



Figure 2 - 30 CLSM leaking inside pipe 1

The CLSM mixture used in the first lift did not present good flowability. The batch presented problems with the cement feed and clogging of the vane feeders resulting in an inconsistent mix during the operation. More details involving the CLSM mixture is given in the next section, including the testing results of the CLSM specimens.

#### *2.5.2 CLSM Mix Design and Test Specimens*

The CLSM specimen testing was conducted by Fugro Consultants, as part of the geotechnical study for the Integrated Pipeline Project of Native Soil Reuse and CLSM.

The tests performed are typical construction control tests for CLSM: flow test, unit weight, air content, and temperature. The ASTM D 6023 presents the procedure to measure the unit weight, and air content of the CLSM. The ASTM D 6103 describes the procedures for the flow test. The results for these tests are shown in Table 4. The CLSM mix poured up to 30% O.D. was not considered representative because of the problems of an ununiformed mixture.

Table 4 Construction Test Results

MIX	FLOW TEST (inXin)	UNIT WEIGHT (Pcf)	AIR CONTENT (%)	TEMPERATURE (C)
CLSM Mix up to 30% O.D.	4x4	107.29	1.4	70
CLSM Mix up to 70% O.D.	-	-	-	-

For finding the compressive strength (UCS) of the CLSM the unconfined compressive test was also performed. The CLSM specimen cylinders for having a low strength require more care when being tested and, as previously discussed, the ASTM D 4832 describes the test procedures. The summary of the results for unconfined compressive strength tests are in the Table 5 and the complete test results are in the Appendix A for all the specimens.

Table 5 Unconfined Compressive Strength Summary of the CLSM

	CLSM Mix up to 30% O.D.			CLSM Mix up to 70% O.D.		
	UCS (psi) MINIMUM	UCS (psi) AVERAGE	UCS (psi) MAXIMUM	UCS (psi) MINIMUM	UCS (psi) AVERAGE	UCS (psi) MAXIMUM
1 DAY	1.7	2.5	3.4	-	-	-
3 DAYS	-	54.8	-	49.4	55.6	61.8
5 DAYS	-	11.1	-	66.6	67.5	61.8
7 DAYS	5.8	20.7	35.6	68	76.8	92.8
28 DAYS	-	6.2	-	82.2	86.7	93.7

Again, the compressive strength of the CLSM mix poured up to 30% O.D. was not considered representative because of the problems of a not uniformed mixture. At 28 days, the compressive strength of all specimens did not pass 100 psi, keeping the low strength characteristic of the CLSM of being able to be excavated after hardened, in case of pipe repairs.

### *2.5.3 Soil Embedment and Compaction*

For Pipe1 embedment, the CLSM is poured up to 30% of the O.D.; then sand is placed above the CLSM up to 70% O.D. in two lifts of approximately 12 in. each. All the soil was compacted with an impact device called a jumping jack compactor. The sand was compacted to 90% standard proctor density. From the top of the sand to one foot above the pipe's top, ordinary local soil is used and compacted to 95% standard proctor density in two lifts of 12 in. each, also using the jumping jack compactor.

For Pipe2 and Pipe3 embedment, the CLSM is used up to 70% of the O.D. and is poured in two lifts. From the CLSM to one foot above the pipe's top, ordinary local soil is compacted to 95% standard proctor density in two lifts of 12 in. each.

The degree of compaction is measured in percent standard Proctor, where the in-place dry density is compared to the laboratory maximum dry density. The laboratory maximum density compaction curve is determined following the procedure described in ASTM D 698, where same soil specimens at various moisture contents are compacted into cylinders and their respective resulting densities (unit dry weight) are measured and plotted. The peak of the curve is the maximum dry density. A standard compaction energy input is used provided by a rammer, dropping a set number of times on the soil.

The in-place density was measured using the nuclear moisture density meter and followed the test procedure described in ASTM D 6938. The soil surface is prepared by using the scraper plate to smooth the surface, fill voids, and make a template for the gauge. A rod is used to drill a hole where the gauge source rod will be inserted. The gauge is placed and measures the soil density by attenuation of gamma radiation. Figure 2-31 shows the nuclear density meter used to measure the in-place moisture density for all soil layers, including backfilling.



Figure 2 - 31 Nuclear moisture density meter

The Appendix B contains the results for the proctor compaction curves - the laboratory maximum dry density for the two types of soils used in the field test, the sand (Poorly Graded Sand with Silt) and local soil (Lean Clay with Sand). Also, it contains the results for the in-place moisture density test, performed twice in each soil layer compacted around the pipes, and the degree of compaction (% Proctor).

### 2.6 Field Test Installation - Backfilling

Before the backfilling of the trench started, the struts were removed. The struts are essential to keep the circular shape of steel pipes during transportation, and their removal occurred after the embedment was completed. Each pipe had 3 struts per section at approximately one third of the pipe length. The struts were cut manually and removed from the pipe through the manholes.

Approximately 5 ft. of local soil was backfilled in two lifts of 2.5 ft. for the three pipes. The soil was placed using the backhoe soil shredder and was poured until it reached the desired layer height.

After the soil was placed, the first compaction was provided by the backhoe adapted with a sheepfoot roller. As described by Howard (1996), the sheepfoot or padfoot rollers feet penetrate the soil surface, and a mixing or blending action results in breaking the soil clods. Because the feet are separated, multiple passes are required and compaction occurs at the bottom of the layer, resulting in a very disturbed surface appearance. Figure 2-32 shows the sheepfoot roller and Figure 2-33 shows the first backfill layer soil being compacted.



Figure 2 - 32 Sheep foot roller compactor



Figure 2 - 33 Compaction of the first backfilling layer



To achieve 95% proctor with a sheepfoot roller, the soil lifts should not exceed 9 in., however, the trench backfilling layer had a thickness of 2.5 ft. For this reason, the backfilling layers surface were compacted using impact hammers (jumping jacks). The Figure 2-34 shows the surface of the first backfilling layer after being compacted. The Appendix B shows the proctor density results for all the backfilling layers.

The process was repeated for the second soil layer (5 ft. backfilling total) and the field test was then completed. Figure 2 - 34 shows the trench completely filled with backfilling soil.



Figure 2 - 35 Soil layer surface after compaction

## 2.7 Field Test Results

The field test consists to monitor the performance of three buried steel pipes in three different trench soil conditions using CLSM. As showed before, Figure 2-1 illustrates the trench profiles for all cases.

The field test acquired the circular displacements and strains of three buried steel pipes: Pipe1, Pipe2, and Pipe3. Recapping, for the Pipe1 the trench width is 120in, and

CLSM is used as embedment up to 30% of the O.D. For Pipe2, the trench width is also 120in, and CLSM is used as embedment up to 70% of the O.D. For Pipe3, the trench width is 102in, and CSLM is used as embedment up to 70% of the O.D. From the CLSM to the top of the pipe, ordinary local soil is used and compacted. Also, five feet of backfilling soil is added for all trenches.

The displacement transducers are installed to record both vertical and horizontal diameter displacement. The strain gages are attached inside and outside of the pipe to obtain the circumferential strain. The buried pipes are monitored during the construction and up to 350 days. The results for pipe structural monitoring are shown and described as follow.

#### *2.7.1 Deflection and Strains Pipe 1*

The Figure 2-36 and Figure 2-37 show the horizontal and vertical displacement of Pipe1 during construction.

The pipe 1 CLSM casting presented problems and the displacement results for section 1 and section 2 present discrepancies due to pipe floating and CLSM influx inside of the pipe. During the CLSM casting the vertical displacement transducers were disturbed and their recording data cannot be taken into consideration. After inspection and calibration the displacement transducers for section1 and section2 were able to record the displacements. The CLSM casting and its problems are described in the section Controlled Low Strength Material Installation. The results for section 1 should not be considered.

The Pipe1 displacements for the placement and compaction of Sand layer1 are positive indicating that the compaction force of a soil layer below the spring line applies

forces that generate upward vertical displacements. This upward effect is presented on both Section1 and Section2.

The compaction of Sand layer2 above the spring line and the subsequent soil layers, 1<sup>st</sup> Native, 2<sup>nd</sup> Native, Backfilling 1, and Backfilling 2 present the expected downward displacements.

It is important to emphasize that the Pipe1 had struts until the 2<sup>nd</sup> Native soil was placed, reproducing the construction of the pipelines common practice of leaving the struts until the pipe is surrounded by the embedment. The struts were removed and no significant difference in displacement was recorded.

Pipe1 section 1 and section 2 present different deflection results. Due to pipe floating, the CLSM presented different depths along the pipe which is embedded differently at section 1 and section 2. At section1 the pipe presents 20 in. CLSM bedding but smaller depth of CLSM. At section 2 the CLSM bedding is 12 in. and its depth is bigger. These values are approximations since it is difficult to measure after the CLSM is placed. Also, the first batch of CLSM used in the Pipe1 presented values of extremely low compressive strength, which was suitable to CLSM containing too much soil and water.

Figure 2-38 and Figure 2-39 show the horizontal and vertical displacements of the Pipe1 for both sections during the complete test duration. After the trench construction was finished, the displacements were recorded for approximately 25 days and show a small increase in the deflection with time. The disturbances showed are related to rain that drained into the pipe. The pipe test was interrupted after 25 days of recording due to torrential rain that flooded the pipe with water. At 155 days the test was restarted after the water was drained and the displacement transducers were repaired. The displacements present an increase with time but the final deflections are under the

2% O.D. limit. The vertical displacement for Pipe1 recorded based on Section 2 is approximately 0.5 in. The horizontal displacement for Pipe1 is approximately 0.25 in.

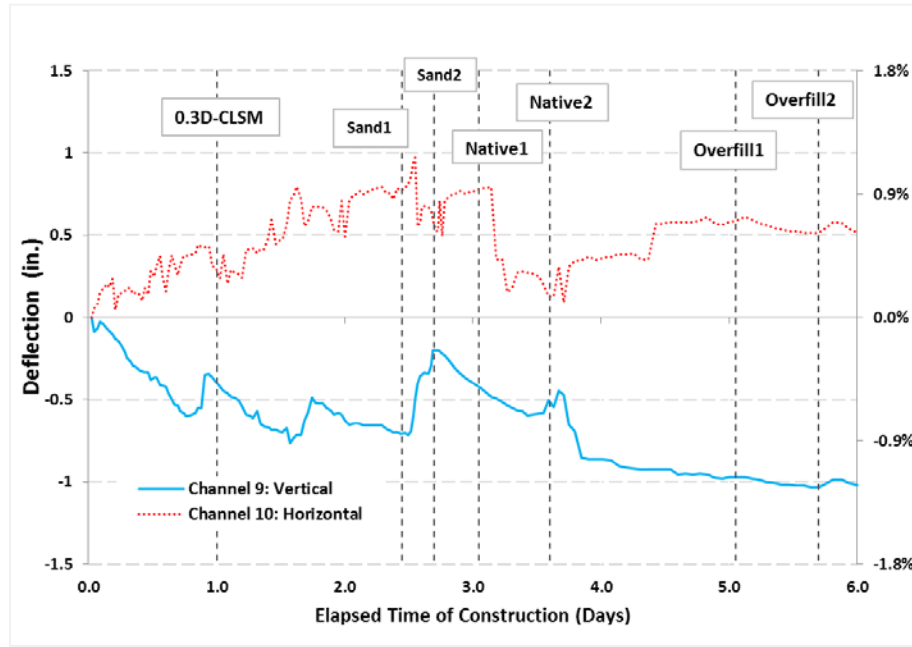

Figure 2 - 36 Displacement Pipe 1 – Section 1

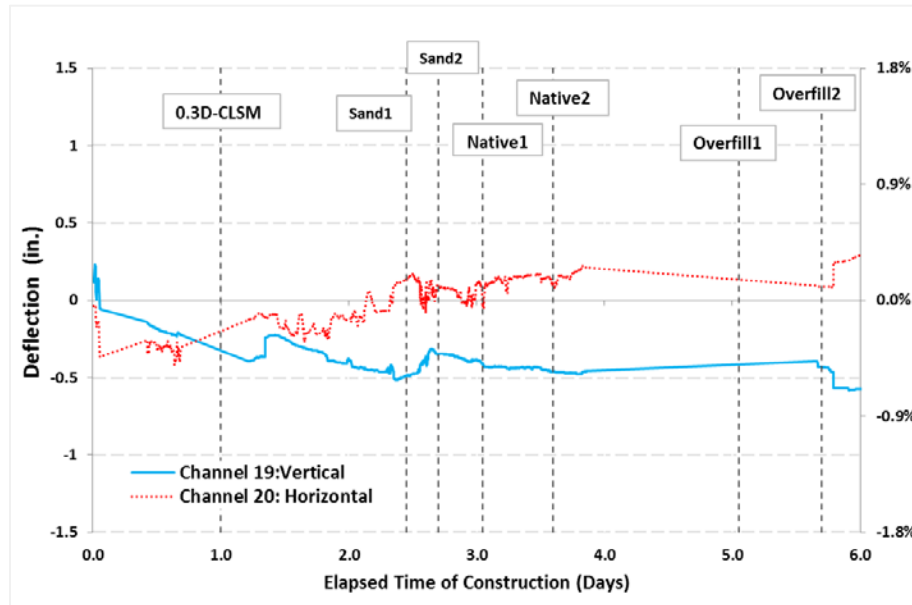

Figure 2 - 37 Displacement Pipe 1 – Section 2

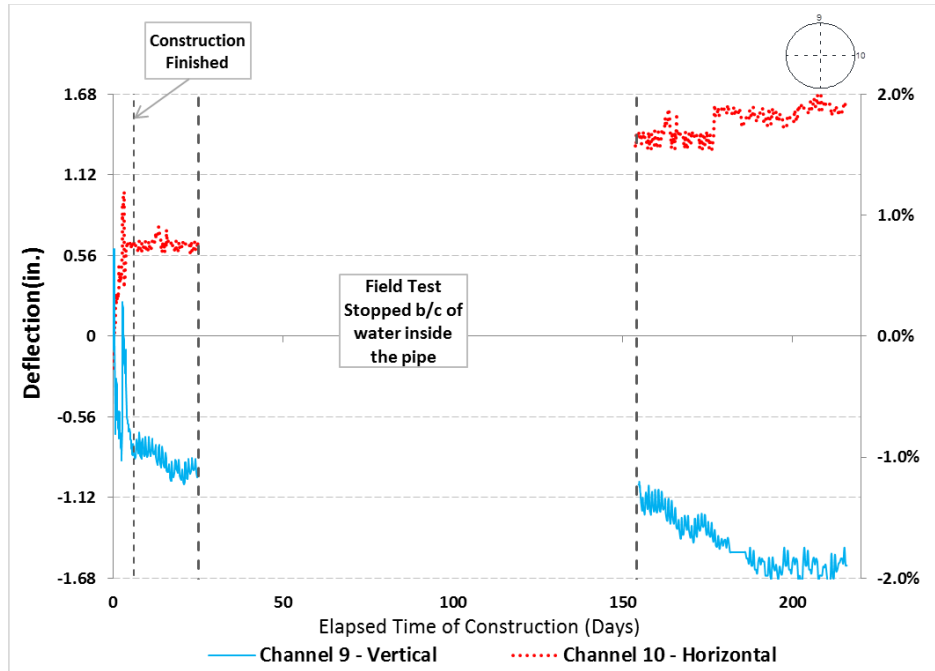

Figure 2 - 38 Monitoring Displacement Pipe 1 – Section 1

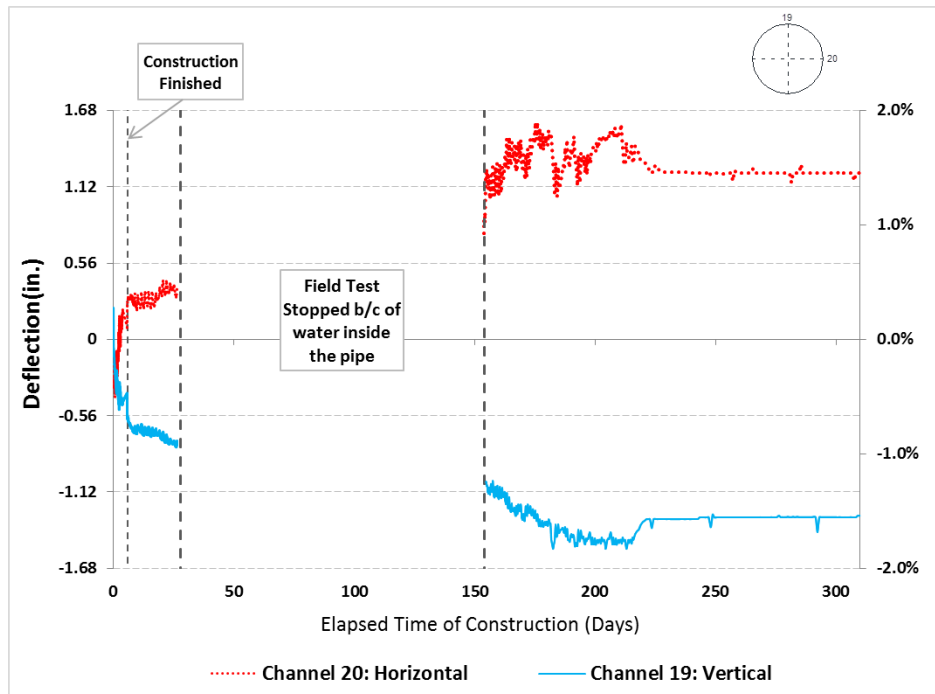

Figure 2 - 39 Monitoring Displacement Pipe 1 – Section 2

The Figure 2-40 to Figure 2-47 shows the strain of Pipe1 during construction.

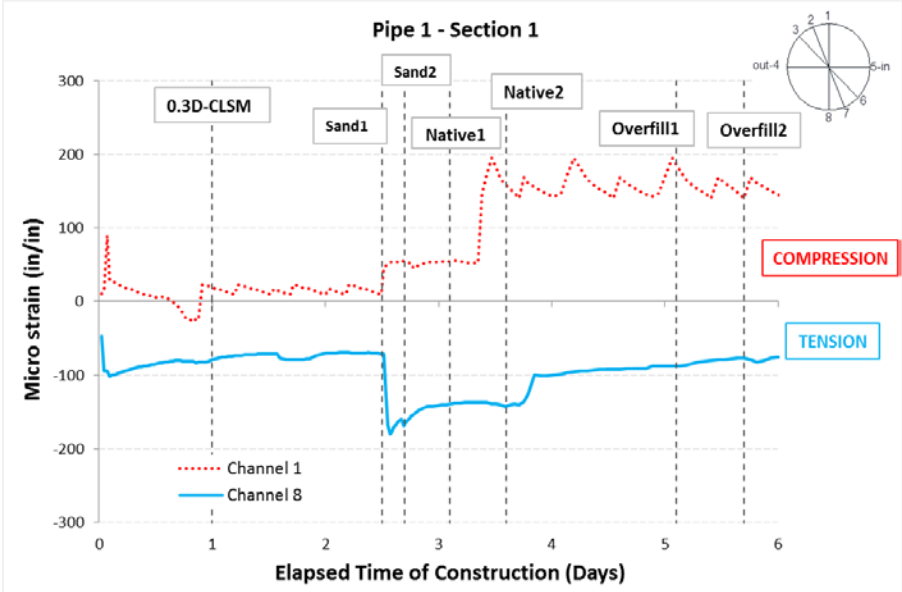

Figure 2 - 40 Strain Pipe 1 – Section 1

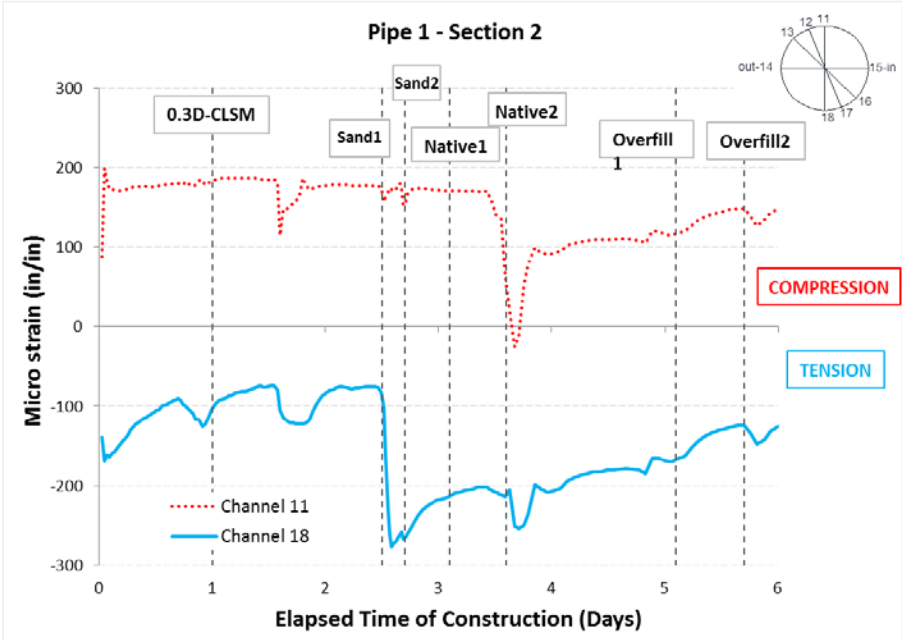

Figure 2 - 41 Strain Pipe 1 – Section 2

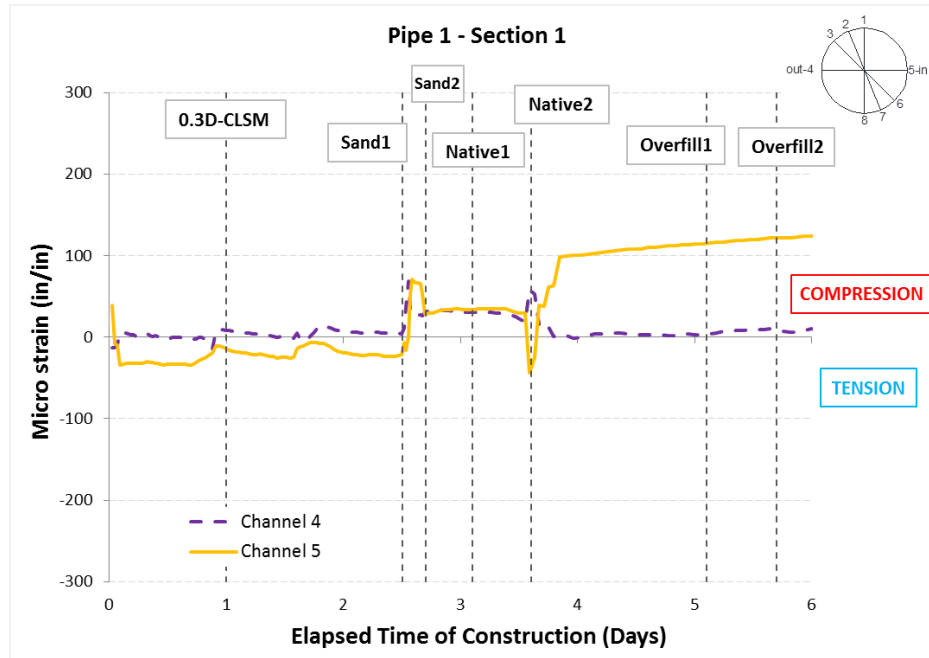

Figure 2 - 42 Strain Pipe 1 – Section 1

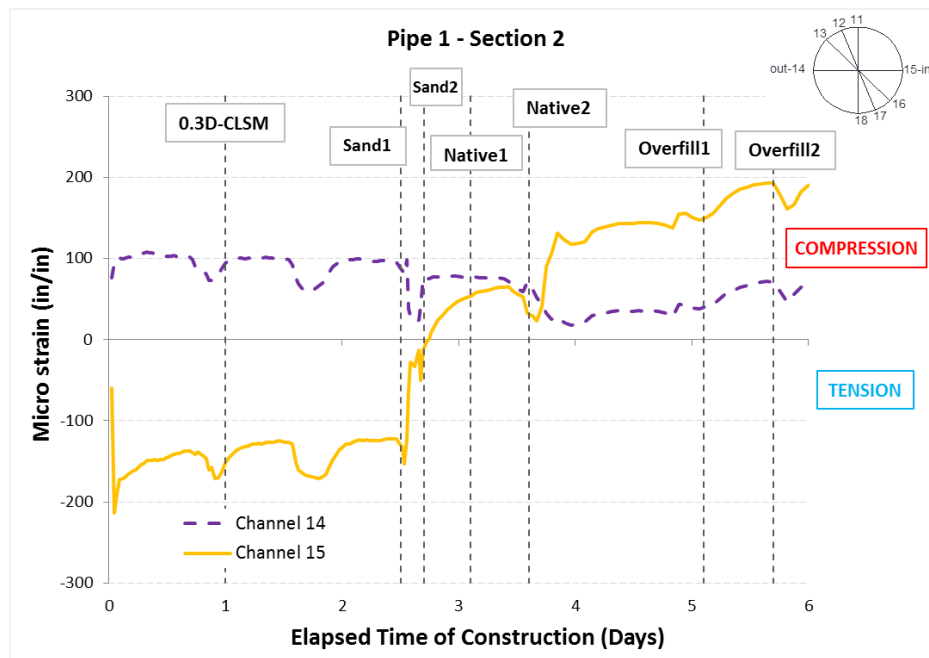

Figure 2 - 43 Strain Pipe 1 – Section 2

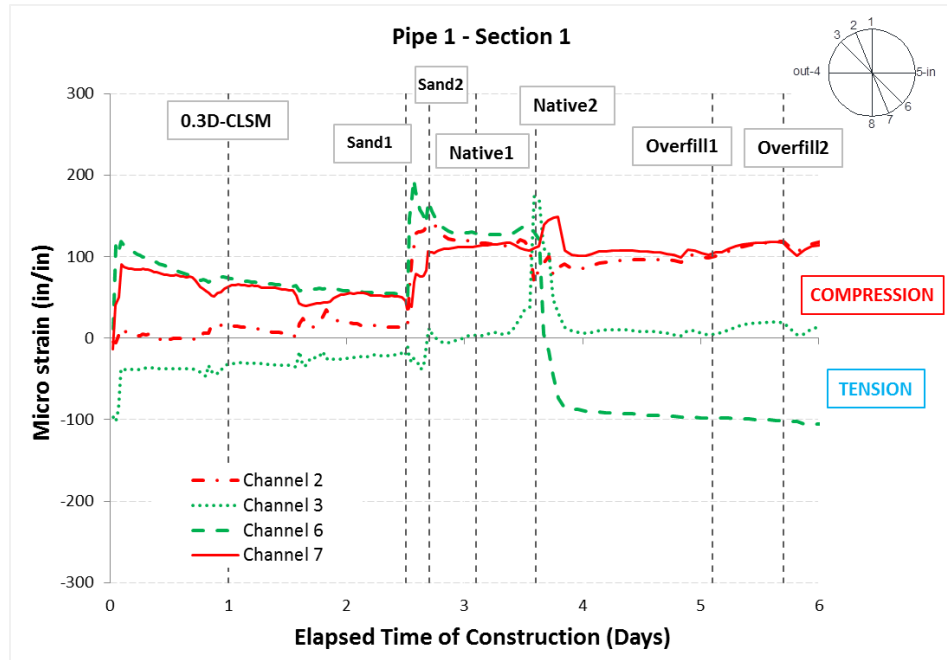

Figure 2 - 44 Strain Pipe 1 – Section 1

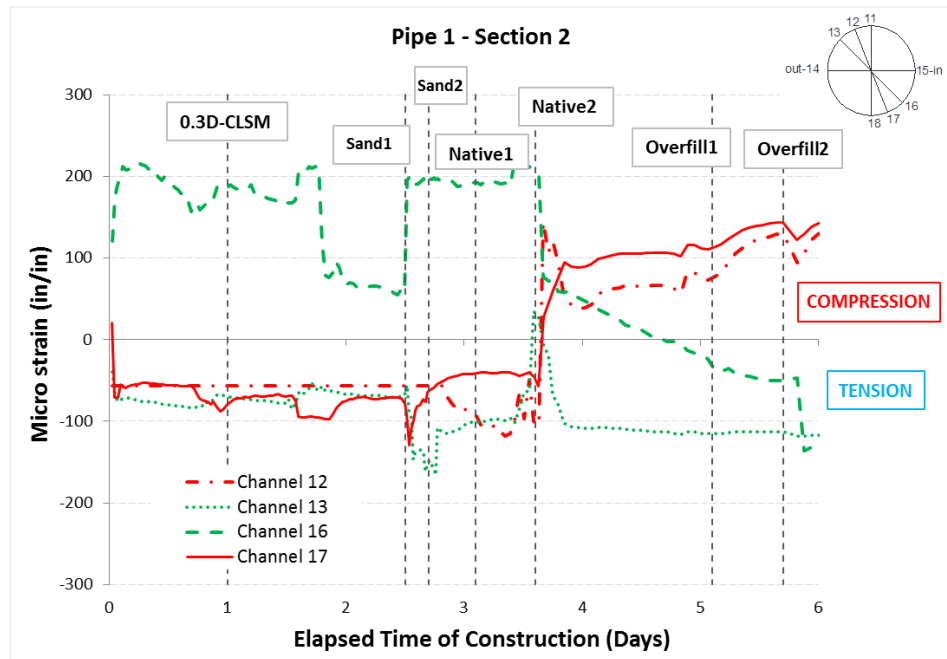

Figure 2 - 45 Strain Pipe 1 – Section 2



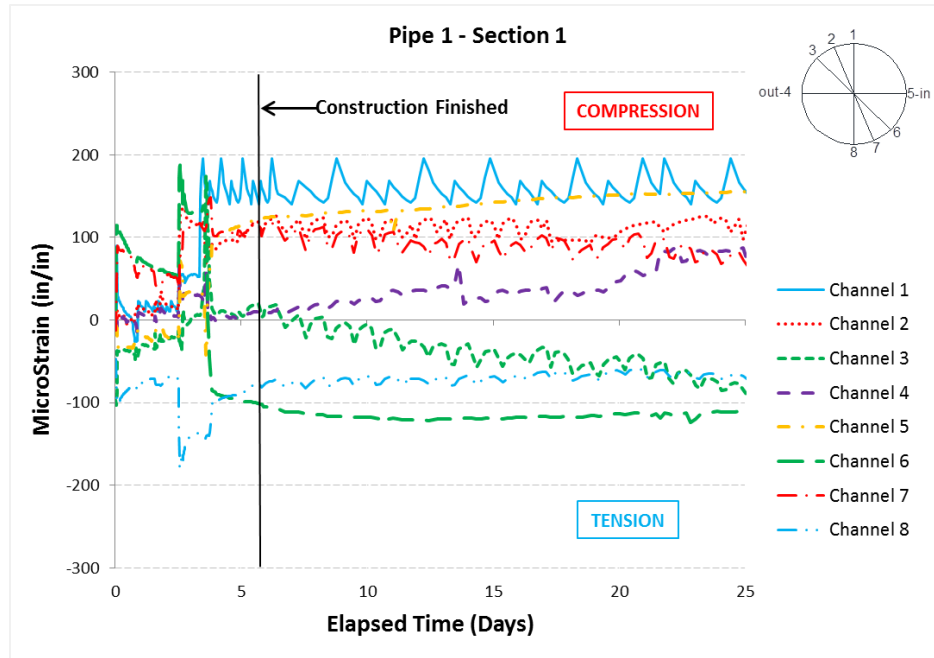

Figure 2 - 46 Monitoring Strain Pipe 1 – Section 1

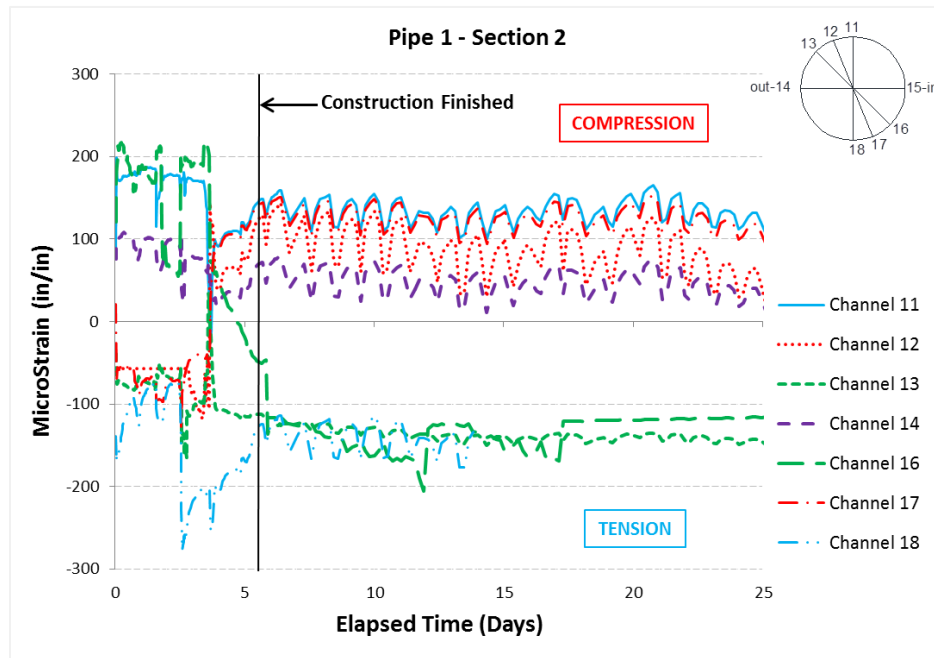

Figure 2 - 47 Monitoring Strain Pipe 1 – Section 2

### *2.7.2 Deflection and Strains Pipe 2*

The Figure 2-48 and Figure 2-49 show the horizontal and vertical displacement of Pipe2 during construction.

The Pipe2 CLSM casting was performed in two days to reduce pipe floating. The CLSM was placed to 0.3 O.D. at day one and from 0.3 to 0.7 O.D. at day two. The displacement results for section 1 and section 2 present minor discrepancies due to differences in the trench profile (common geometry differences due to trench excavation). The placement of the CLSM produced disturbances in the displacement reading, which is normal since the CLSM is poured on top of the pipe. After CLSM casting, by inspection, the displacement transducers for section1 and section2 were not affected by any CLSM leaking and were able to record the displacements.

The compaction of Sand layer2 above the spring line and the subsequent soil layers, 1<sup>st</sup> Native, 2<sup>nd</sup> Native, Backfilling 1, and Backfilling 2 present the expected downward displacements. The Pipe2 also had struts until the second native soil was placed, reproducing the construction of the pipelines common practice of leaving the struts until the pipe is surrounded by the embedment. The struts were removed and, as well for Pipe1, no significant difference in displacement was recorded.

Pipe2 section 1 and section 2 present similar deflection results. The first batch of CLSM used in the Pipe2 also presented values low compressive strength.

Figure 2-50 and Figure 2-51 show the horizontal and vertical displacements of the Pipe2 for both sections during the complete test duration. After the trench construction was finished, the displacements were recorded for approximately 25 days and show a small increase. The disturbances showed are related to rain that drained into the pipe. The pipe test was interrupted after 25 days of recording due to torrential rain that flooded the pipe with water. At 155 days the test was restarted after the water was

drained and the displacement transducers were repaired. The displacements present an increase with time but the final deflections are under the 2% O.D. limit. The vertical displacement for Pipe2 recorded is on average 0.6 in. The horizontal displacement for Pipe2 recorded is on average 0.35 in.

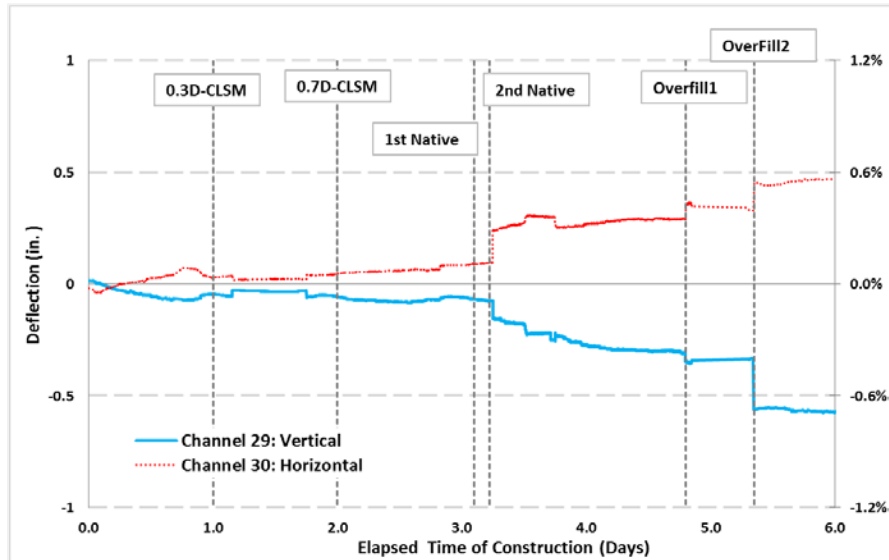

Figure 2 - 48 Displacement Pipe 2– Section 1

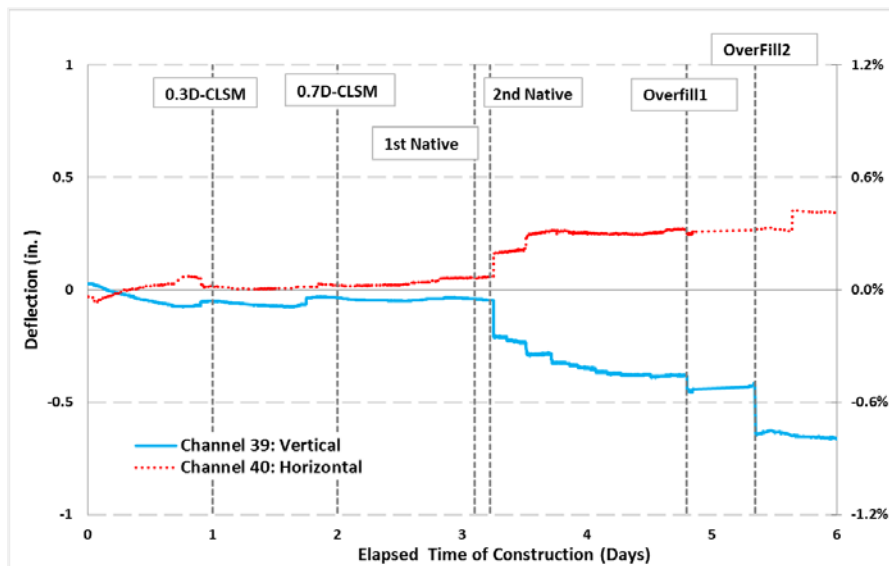

Figure 2 - 49 Displacement Pipe 2– Section 2

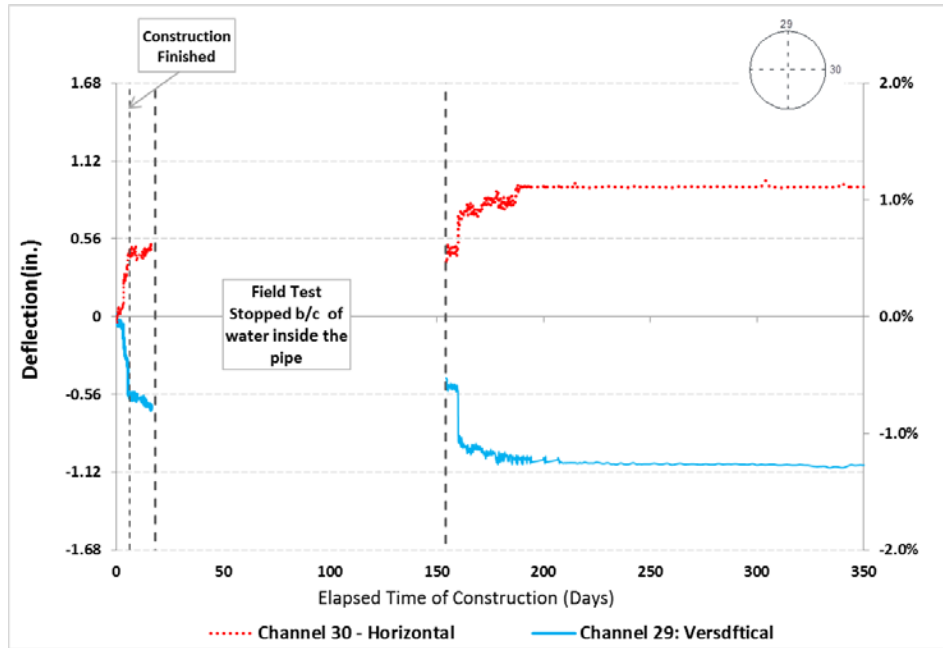

Figure 2 - 50 Monitoring Displacement Pipe 2– Section 1

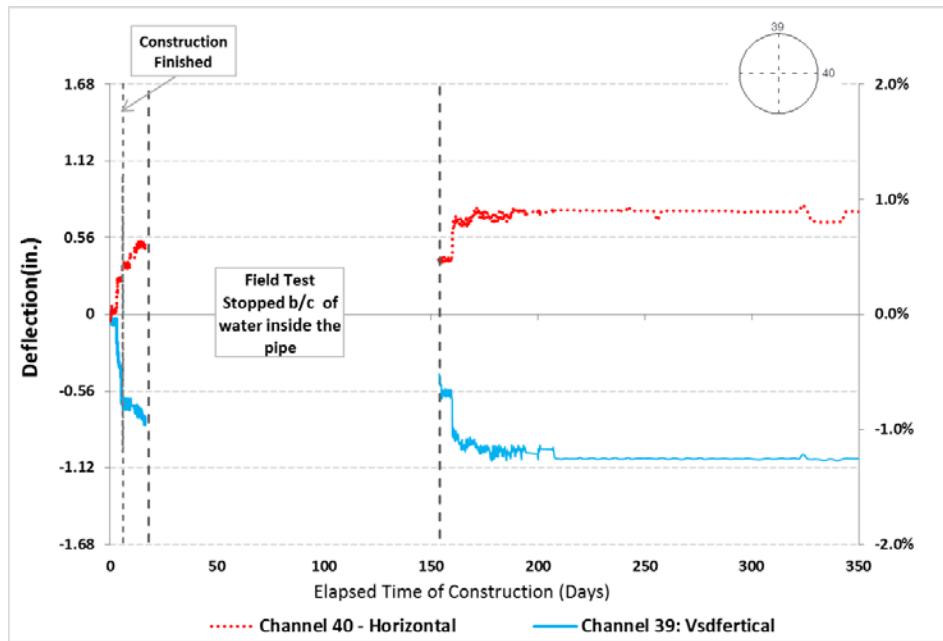

Figure 2 - 51 Monitoring Displacement Pipe 2– Section 2

The Figure 2-52 to Figure 2-59 shows the strain of Pipe2 during construction.

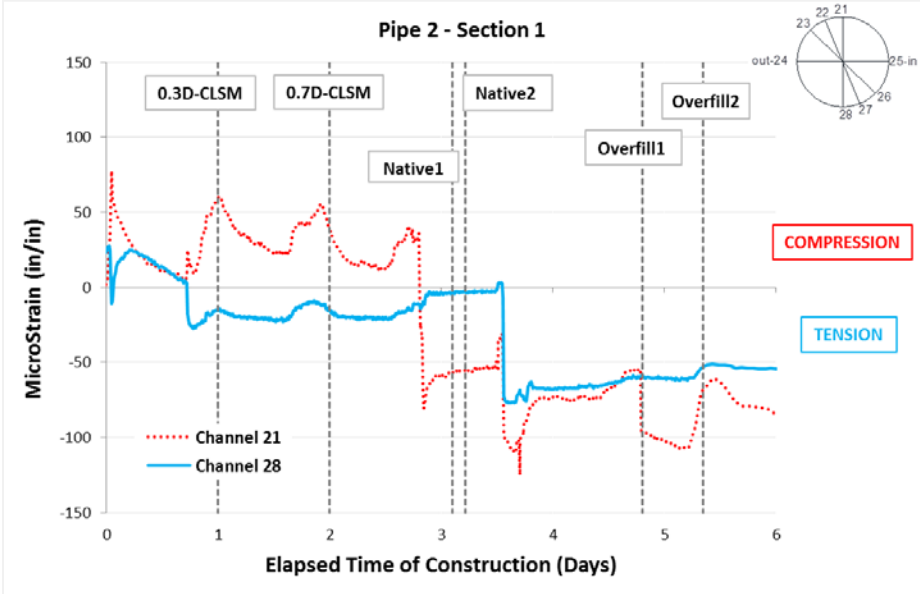

Figure 2 - 52 Strain Pipe 2 – Section 1

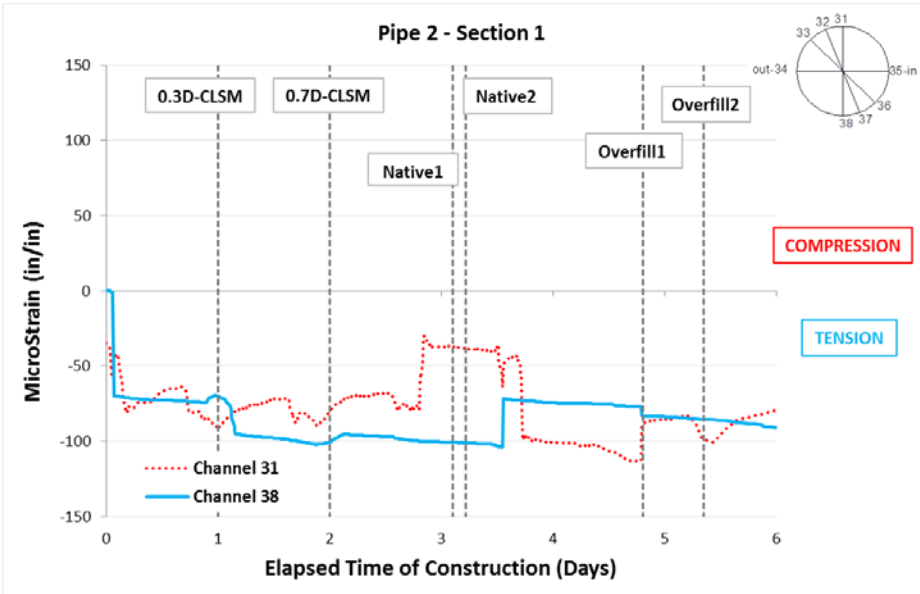

Figure 2 - 53 Strain Pipe 2 – Section 2

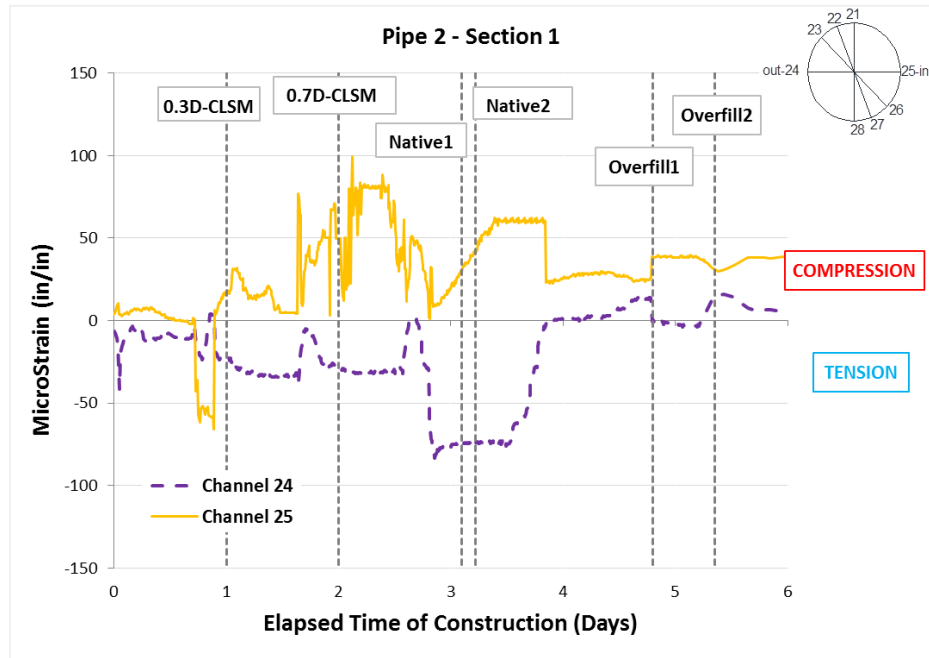

Figure 2 - 54 Strain Pipe 2 – Section 1

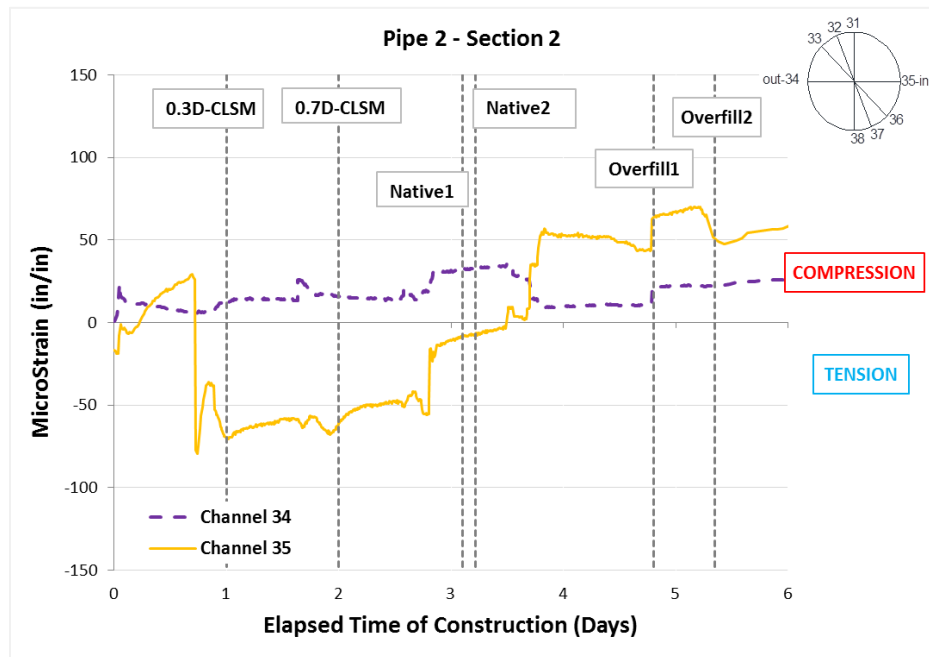

Figure 2 - 55 Strain Pipe 2 – Section 2

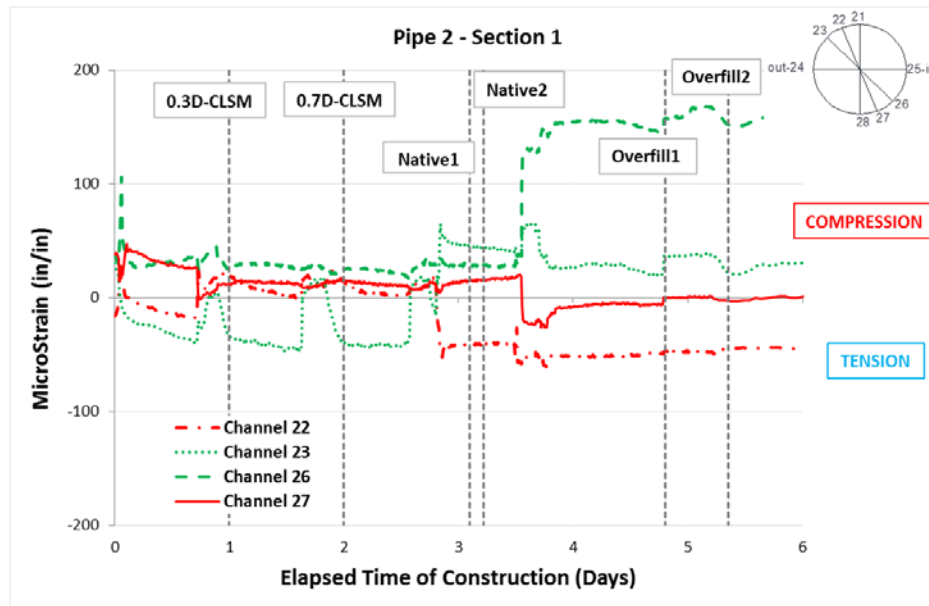

Figure 2 - 56 Strain Pipe 2 – Section 1

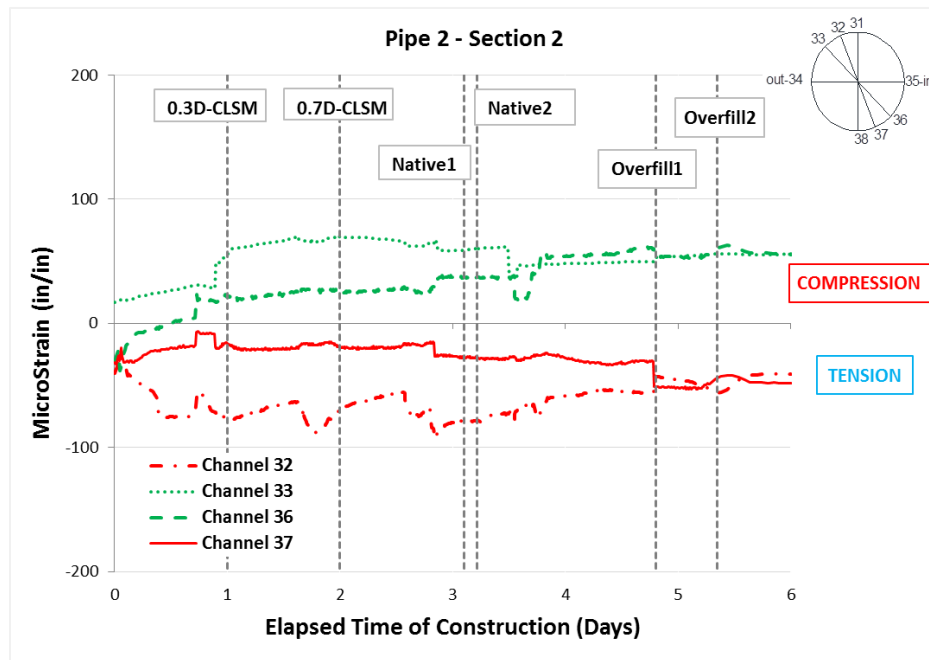

Figure 2 - 57 Strain Pipe 2 – Section 2

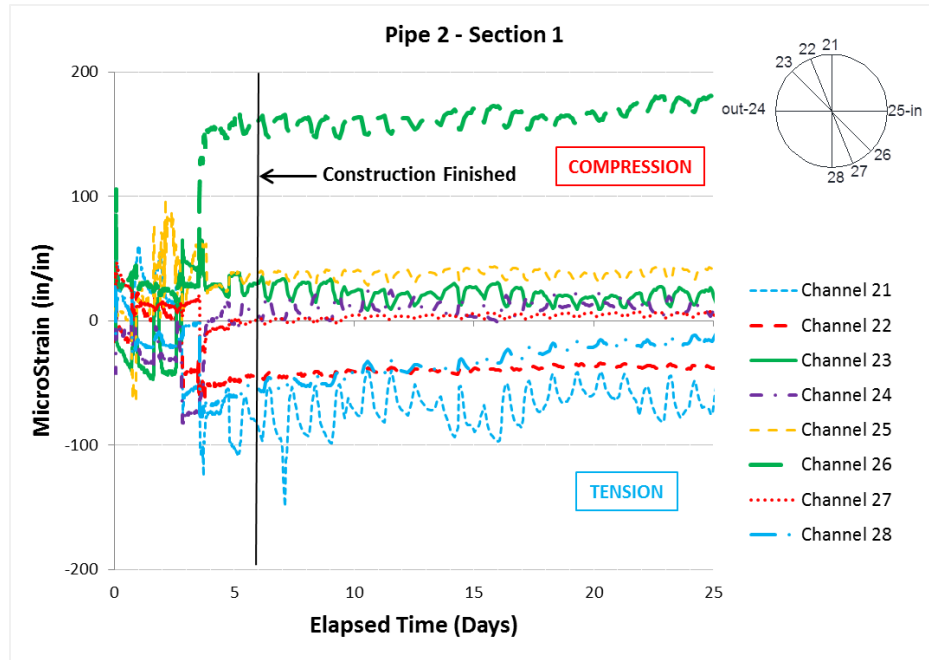

Figure 2 - 58 Monitoring Strain Pipe 2 – Section 1

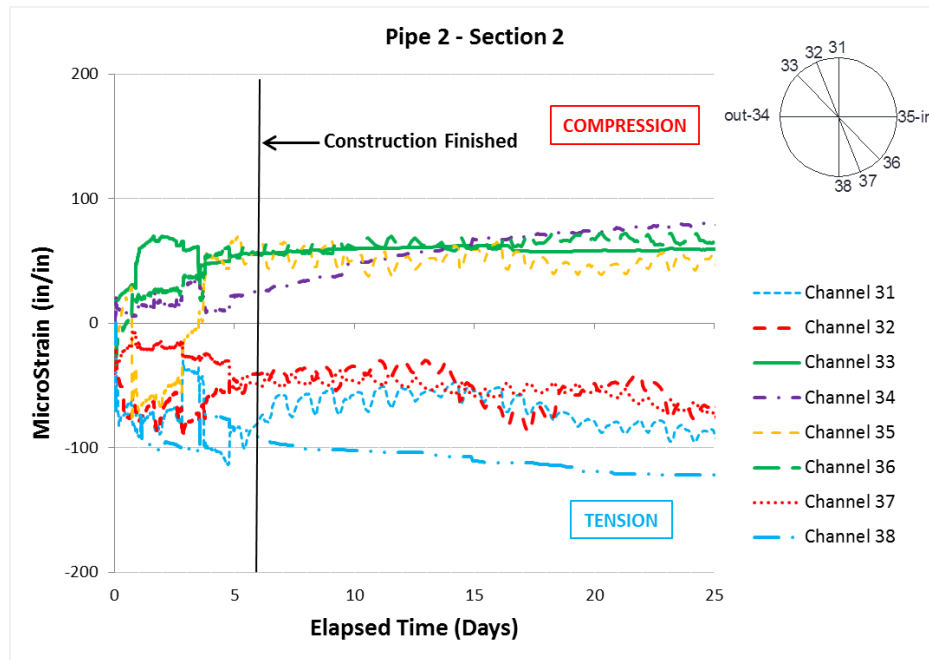

Figure 2 - 59 Monitoring Strain Pipe 2 – Section 2



### *2.7.3 Deflection and Strains Pipe 3*

The Figure 2-60 and Figure 2-61 show the horizontal and vertical displacement of Pipe3 during construction.

The Pipe3 CLSM casting was performed in two days to reduce pipe floating. The CLSM was placed to 0.3 O.D. at day one and from 0.3 to 0.7 O.D. at day two. The displacement results for section 1 and section 2 present minor discrepancies due to differences in the trench profile (common geometry differences due to trench excavation). The placement of the CLSM produced disturbances in the displacement reading, which is normal since the CLSM is poured on top of the pipe. After CLSM casting, by inspection, the displacement transducers for section1 and section2 were not affected by any CLSM leaking and were able to record the displacements.

The compaction of Sand layer2 above the spring line and the subsequent soil layers, 1<sup>st</sup> Native, 2<sup>nd</sup> Native, Backfilling 1, and Backfilling 2 present the expected downward displacements. The Pipe3 also had struts until the 2<sup>nd</sup> Native soil was placed, reproducing the construction of the pipelines common practice of leaving the struts until the pipe is surrounded by the embedment. The struts were removed and, as well for Pipe1 and Pipe 2, no significant difference in displacement was recorded.

Pipe3 presents similar deflection results for Section 1 and Section 2.

Figure 2-62 and Figure 2-63 show the horizontal and vertical displacements of the Pipe3 for both sections during the complete test duration. After the trench construction was finished, the displacements were recorded for approximately 25 days and show to be relatively constant. The disturbances showed are related to rain that drained into the pipe. . The pipe test was interrupted after 25 days of recording due to torrential rain that flooded the pipe with water. At 155 days the test was restarted after the water was drained and the displacement transducers were repaired. The displacements

present an increase with time but the final deflections are under the 2% O.D. limit. The pipe test was interrupted after 25 days of recording due to torrential rain and snow that flooded the pipe with water. The vertical displacement for Pipe3 recorded is on average 0.7 in. The horizontal displacement for Pipe3 recorded is on average 0.5 in.

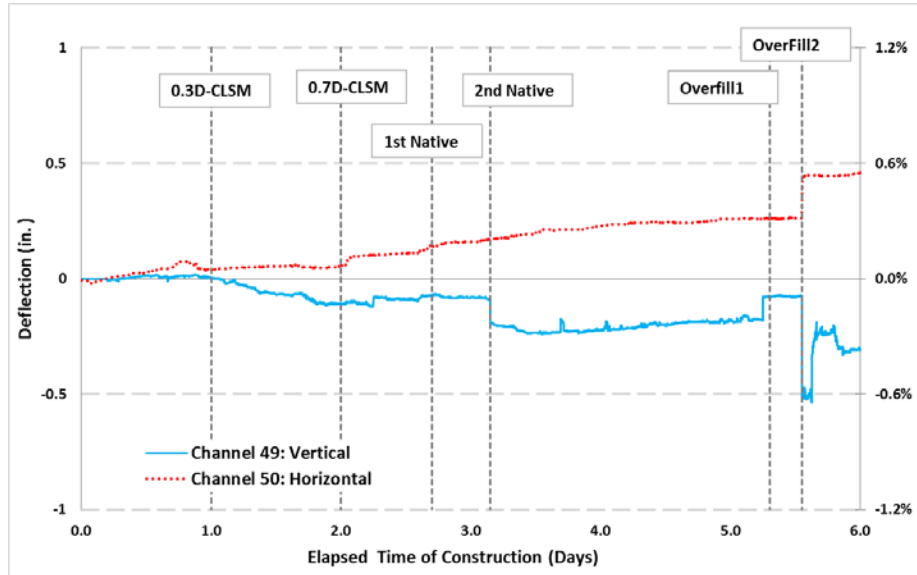

Figure 2 - 60 Displacement Pipe 3– Section 1

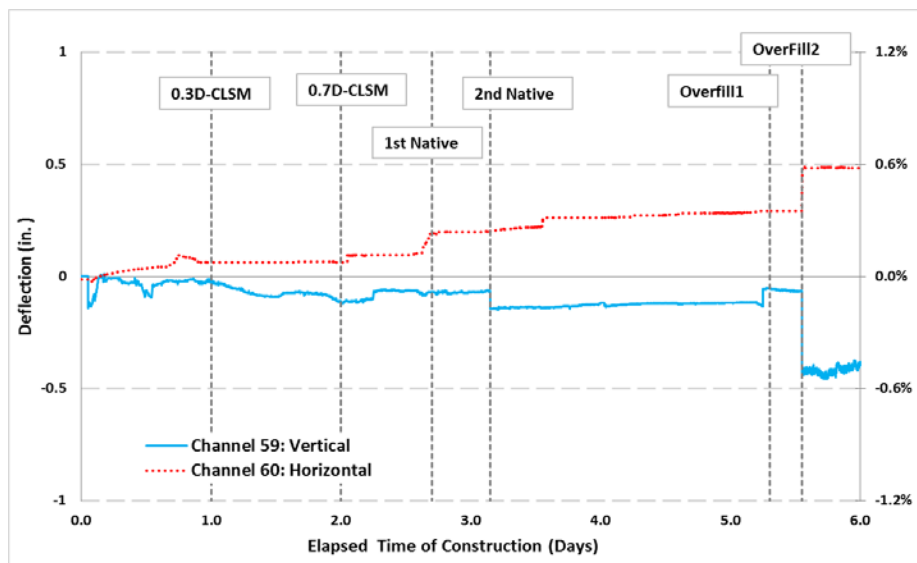

Figure 2 - 61 Displacement Pipe 3– Section 2

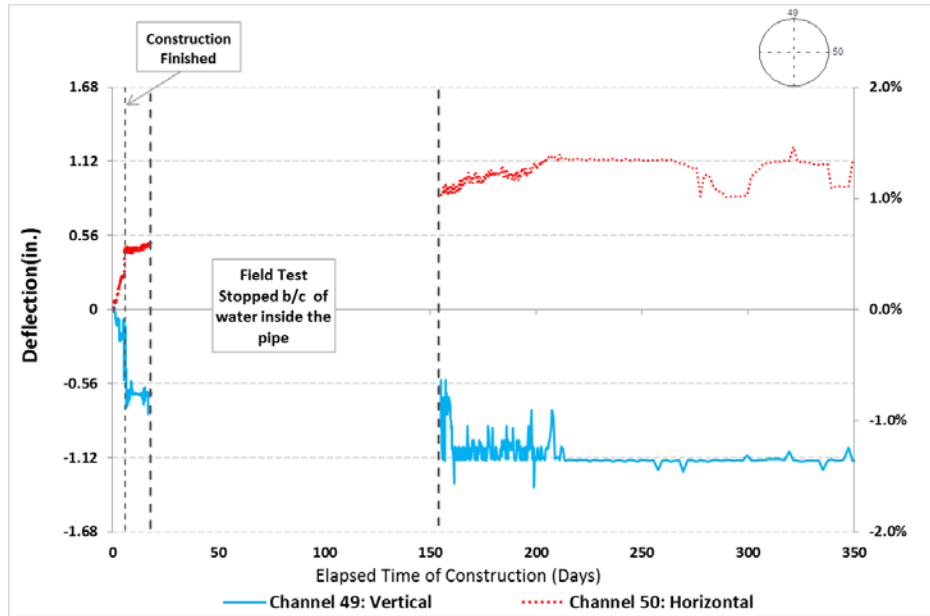

Figure 2 - 62 Monitoring Displacement Pipe 3– Section 1

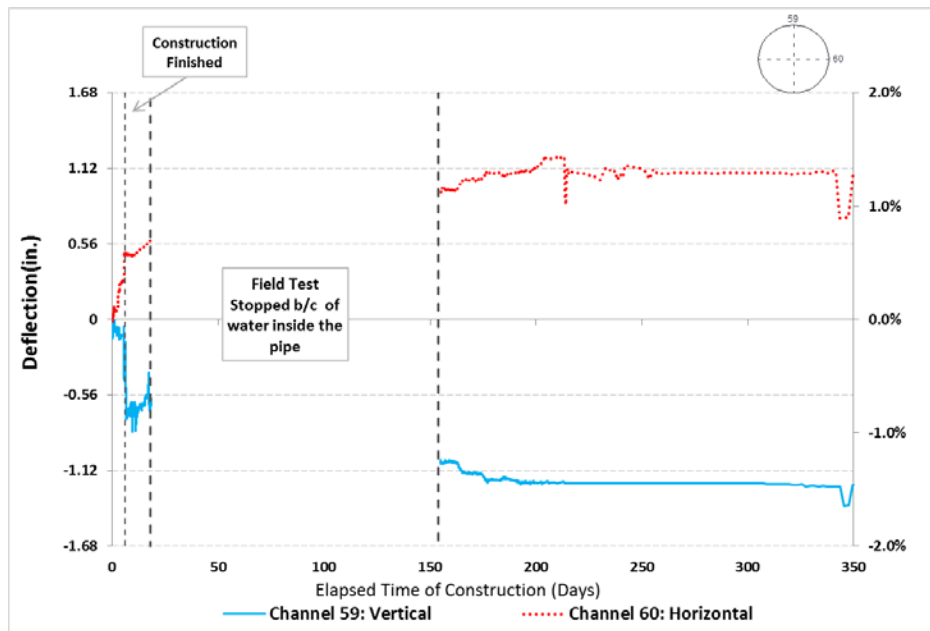

Figure 2 - 63 Monitoring Displacement Pipe 3– Section 2

The Figure 2-64 to Figure 2-70 shows the strain of Pipe1 during construction.

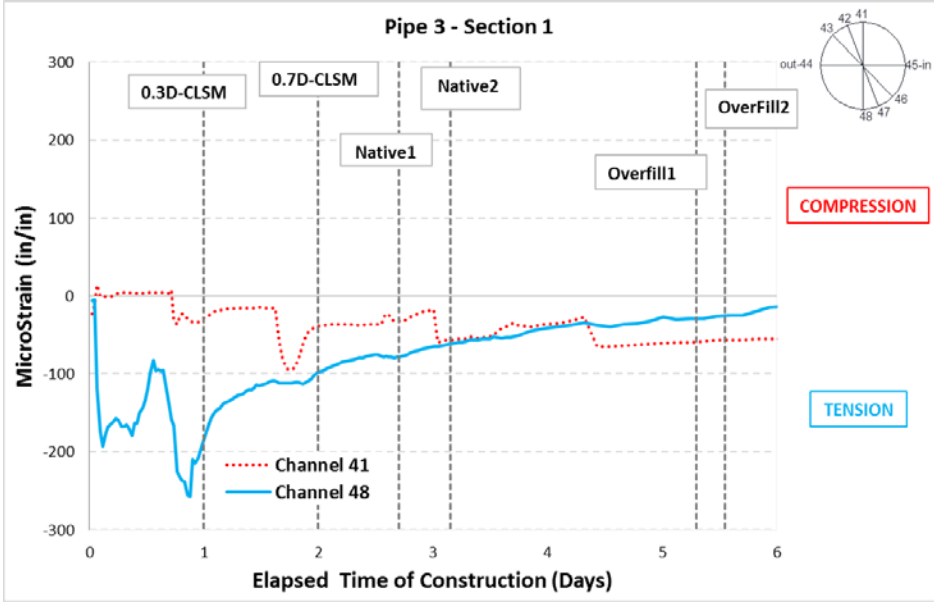

Figure 2 - 64 Strain Pipe 3 – Section 1

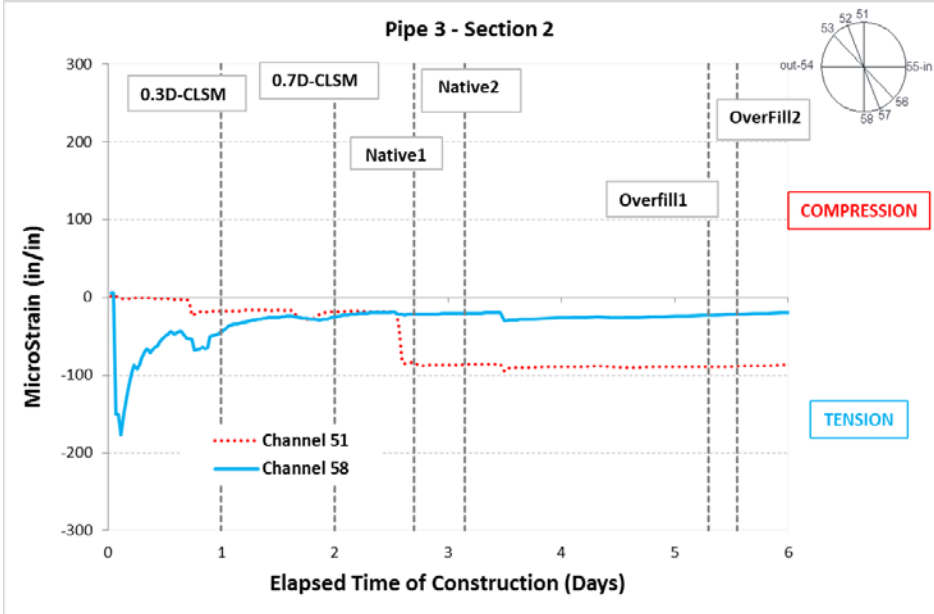

Figure 2 - 65 Strain Pipe 3 – Section 2

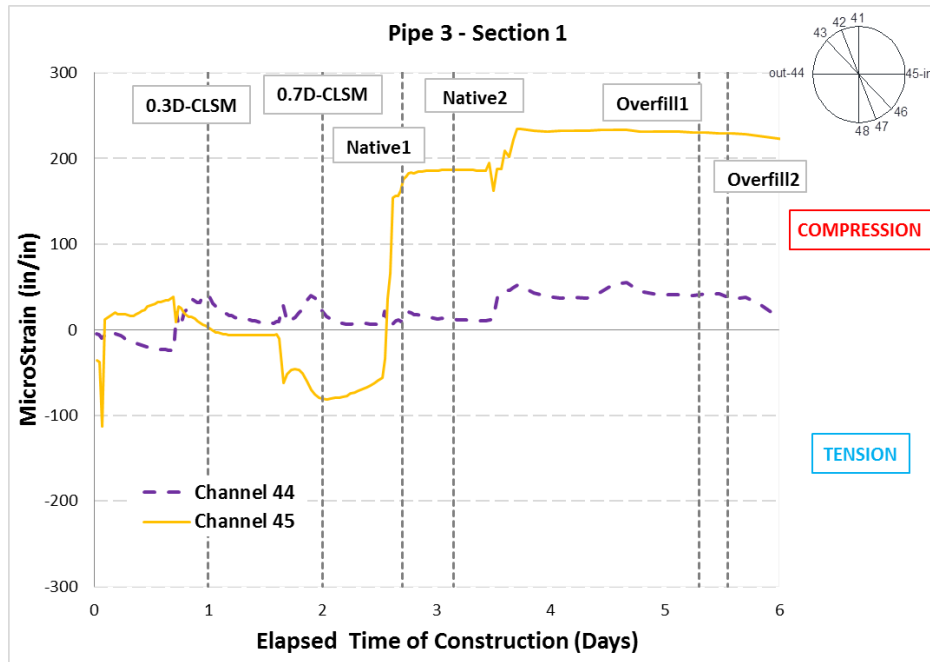

Figure 2 - 66 Strain Pipe 3 – Section 1

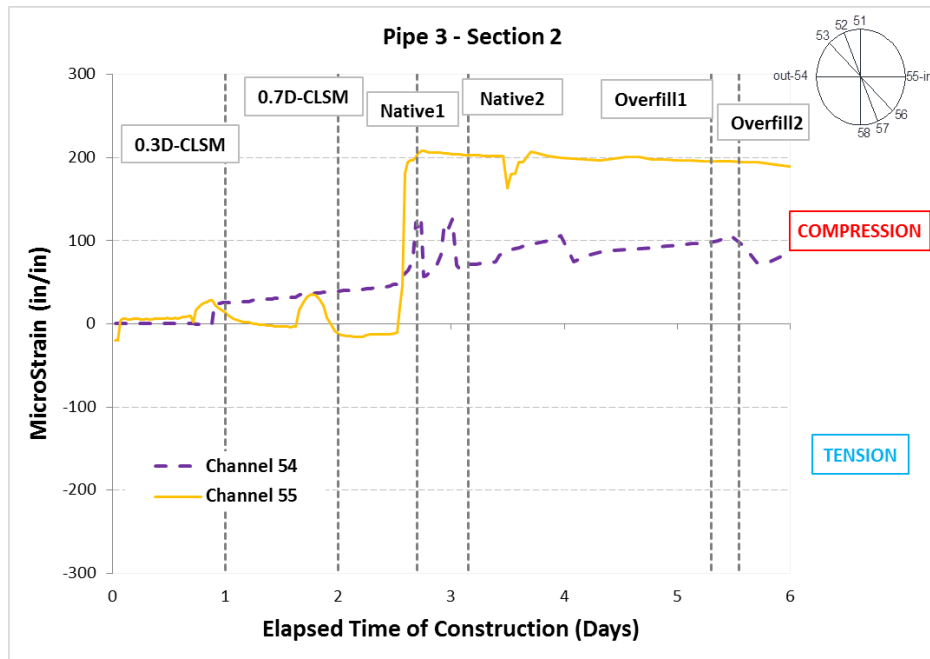

Figure 2 - 67 Strain Pipe 3 – Section 2

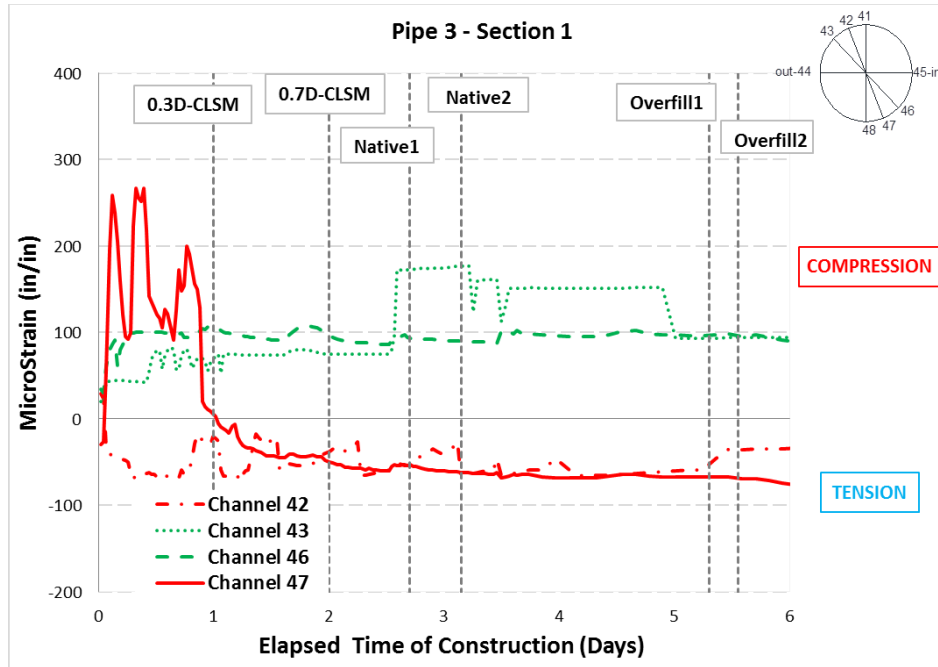

Figure 2 - 68 Strain Pipe 3 – Section 1

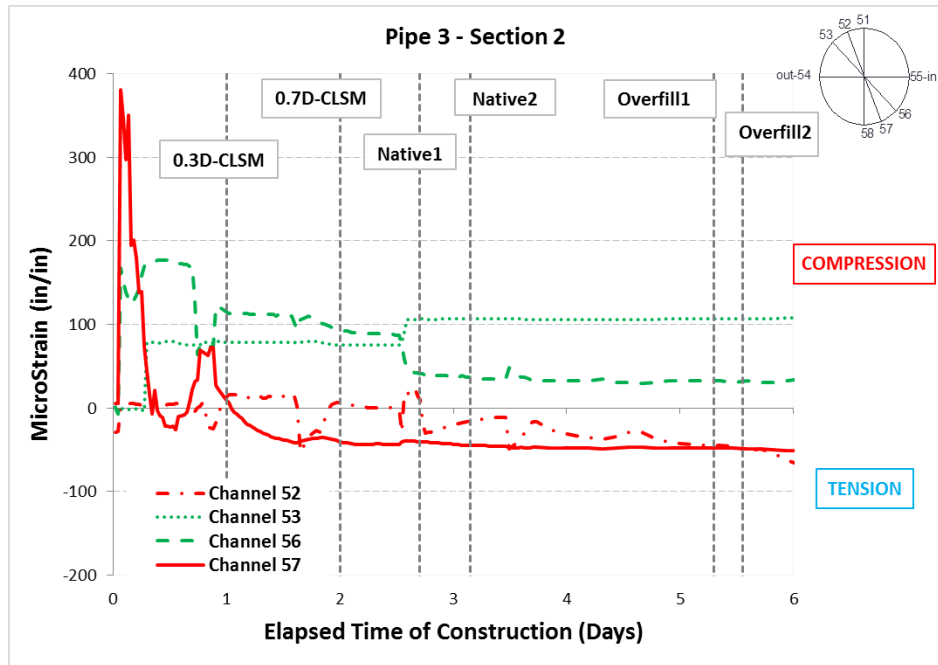

Figure 2 - 69 Strain Pipe 3 – Section 2

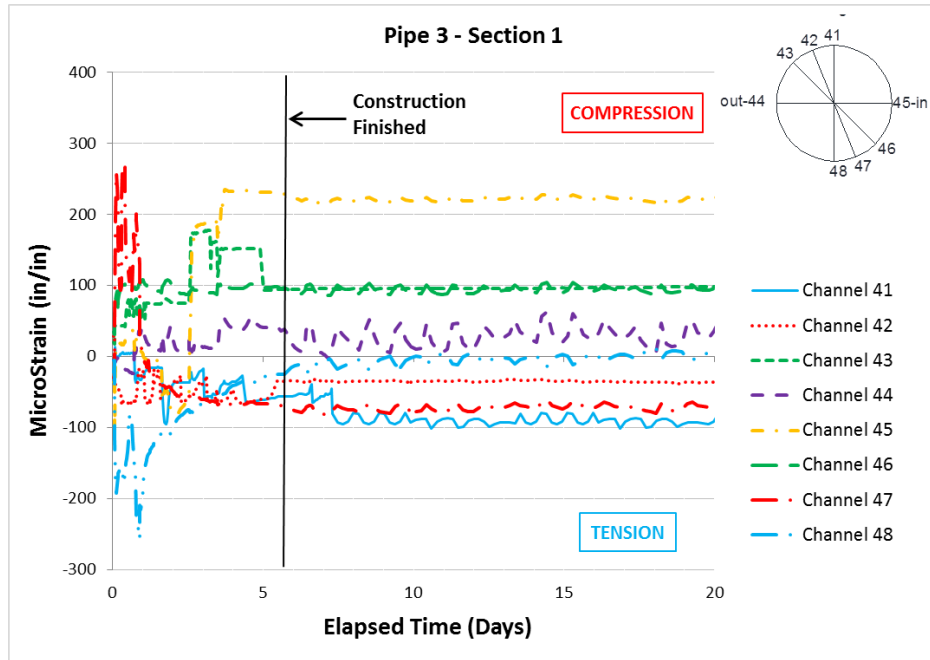

Figure 2 - 70 Monitoring Strain Pipe 3 – Section 1

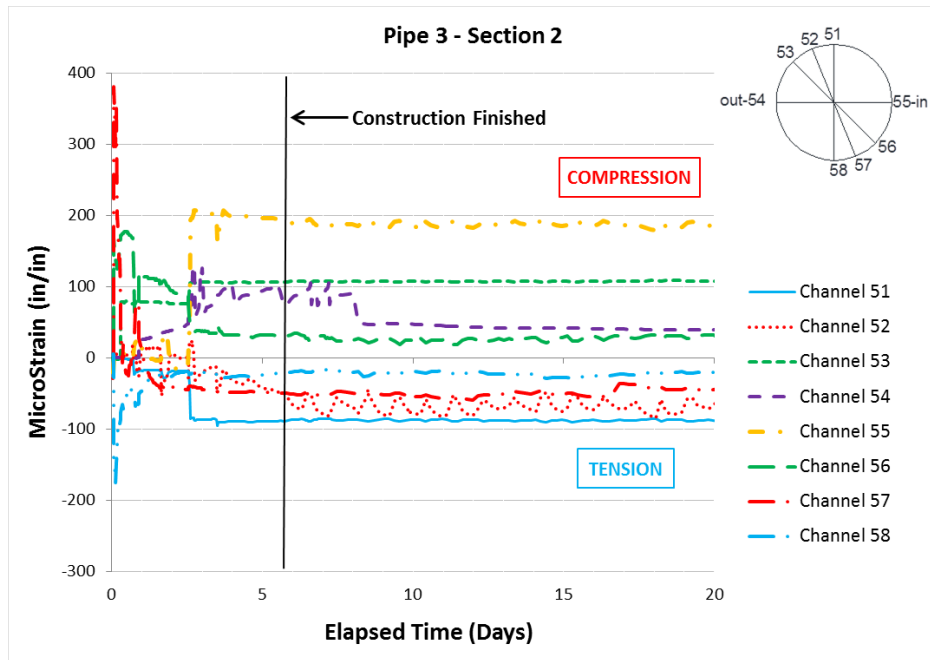

Figure 2 - 71 Monitoring Strain Pipe 3 – Section 2

## Chapter 3

### Finite Element Analysis

#### 3.1 Introduction

A nonlinear three dimensional finite element model (FEM) for steel pipes coupled with CLSM is developed and is capable to simulate the performance of steel pipes under different trench conditions. The model analyzes and reproduces the pipe-soil stiffness system, modeling contact surfaces and soil properties. Also, it includes the trench wall soil and recognizes that a narrow trench with an embedment of stiff soil adjacent to a soft soil trench wall does not provide the same restraint as if was adjacent to a stiff soil trench wall. The finite element model takes into consideration embedment compaction forces that are calibrated based on previously research of buried pipe soil box test conducted at UTA Civil Engineering Laboratory (Dezfooli, 2013).

Once the model is built and verified with field test many different trench conditions can be analyzed. The finite element model can be used to predict the performance of steel pipes in different trench conditions.

The following section describes the development of the finite element models of the three pipes and trench configurations of the field test. The displacement results of the finite element models are then compared with the field test displacement results.

#### 3.2 Finite Element Modeling

The three-dimensional finite element models are developed using the computer program Abaqus Version 6.12-2. The modeling consists in assembling the trench geometry, defining material properties, assembling the trench staged construction, establishing boundary conditions, applying loads, defining contact surfaces, and finally provide appropriate mesh size and element type.



### 3.2.1 Geometry

The geometry of the trench is defined introducing model parts that are created for each of the individual component of the model. The model is composed of several different parts: steel pipe, CLSM, embedment soil, and trench wall. An overview of the model parts is shown in the Figure 3-1.

As described in the field test, the steel pipes have an outside diameter of 84 in. and thickness equals to 0.375 in. The CLSM is used as embedment up to 30% and 70% of the outside diameter (O.D.). From the CLSM to 1 ft. on top of the pipe, compacted soil is placed in two lifts. The trench is backfilled with two native soil layers of 2.5 ft. each.

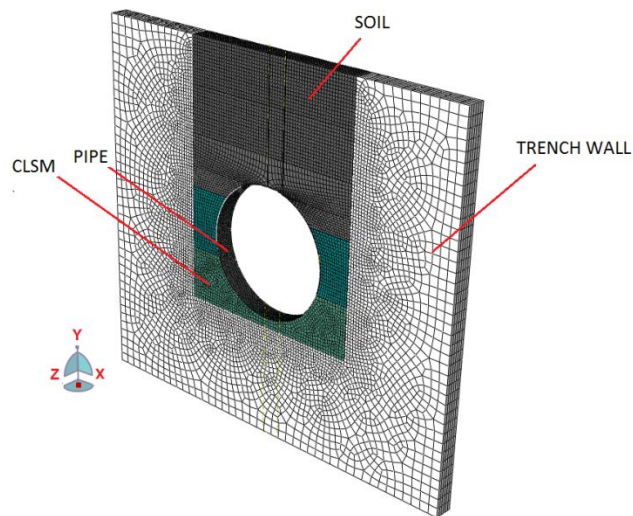

Figure 3 -1 Geometry of the finite element model

The model parts are based on the trench configuration of the field test, reproducing the trench at the instrumented sections (at one third of the total pipe length). The field surveying of the trench determined accurately the profile of the trench for the CLSM bedding, embedment, soil layers, and trench width. Six different models are

created for the reproduction of the field test for Pipe 1, Pipe 2, and Pipe 3 (Sections 1 and Sections 2).

The model of the sections has an optimum 1 ft. thickness in the z direction. Using this thickness the processing time was reduced significantly.

### 3.2.2 Boundary Conditions

The boundary conditions applied in the model are highlighted in the Figure 3-2. In the X axis the translation is restrained on the outside plane of the trench wall. The bottom of the trench wall is also restrained against translation in the X, Y and Z directions.

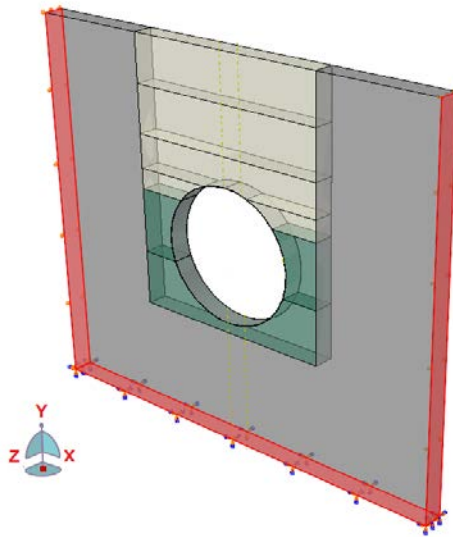

Figure 3 - 2 Finite Element Boundary Conditions

### 3.2.3 Loads

The loads acting on the model are the pipe self-weight, the soil self-weight, CLSM self-weight, soil horizontal load due to compaction and due to lateral at rest pressure, and self-weight backfilling of the trench soil. The loads are introduced after

introducing the part to the model. These loads are vertical (gravity loads) and horizontal loads (soil at rest and compaction forces).

#### 3.2.3.1 Vertical Loads

The vertical loads consist in the self-weight of each part. By applying the gradually increasing gravitational constant from zero to  $386.22 \text{ in/s}^2$  the self-weight of all the part are introduced to the model.

#### 3.2.3.2 Horizontal Loads: Soil Lateral Loads

For the induced lateral pressure due to compaction a horizontal load is applied to the soil layers. According to Dezfooli (2013), the finite element model should consider the effect of embedment compaction isolated or coupled with the at-rest lateral soil. To apply the horizontal load, the stresses due to the at-rest lateral soil pressure and the soil compaction are calculated. Then, the calculated stresses are applied to each soil layer using the equivalent temperature loading. Also, Dezfooli (2013) studies, based on the soil box test, showed that for each soil layer the coefficient of thermal expansion ( $\alpha$ ) is equally defined to be 0.001 for all layers in x-direction and “zero” for the other two directions (y and z). The “ $\alpha$ ” is a virtual value and is not the real thermal expansion of the material.

Compaction and at-rest lateral soil pressure is applied in term of uniform temperature distribution. The  $\alpha\Delta T$  calculated temperature for each soil layer is applied upon activation of that layer.

The equation developed by Dezfooli (2013) for lateral soil pressure due to compaction, using mechanics of material formulation for series of springs and the results from soil box test, is described as follow:

$$\alpha\Delta T = \sigma_s \left( -\frac{A}{LK_{\text{pipe}}} - \frac{A}{LK_{\text{wall}}} - \frac{1}{E_{\text{soil}}} \right) \quad (3.1)$$

Where,

$\sigma_s$  = lateral soil stress (proportional to the compacted undrained shear strength of the clay and is a function of its plastic index – for higher and lower soil plastic indices 0.8Cu and 0.2Cu is recommended for simulation of lateral pressure, respectively)

A = Transverse area of the soil layer

L = Length of the soil layer

$K_{\text{pipe}}$  = Pipe Young's Modulus x pipe thickness

$K_{\text{wall}}$  = Wall soil Young's Modulus x wall soil length

$E_{\text{soil}}$  = Young's Modulus of the soil

#### 3.2.4 Material Behavior and Material Properties

The steel pipe is modeled using isotropic plasticity model. The trench embedment and backfilling soil are modeled using Mohr-Coulomb plasticity model.

The CLSM is modeled with Concrete Damaged Plasticity model using compression strength of 86.7 psi and a Modulus of Elasticity of 18,860 psi and unit weight of 108pcf. These values are test results presented on Appendix A.

The material properties for steel and CLSM are summarized in the Table 6 and 7.

Table 6 Steel Properties

<b>Density</b>	490 pcf
<b>Yield Stress</b>	36 ksi
<b>Modulus of Elasticity</b>	29,000 ksi
<b>Poisson's ratio</b>	0.3

Table 7 CLSM Properties

<b>Density</b>	108 pcf
<b>Compressive Strength</b>	86.7 psi
<b>Modulus of Elasticity</b>	18,860 psi
<b>Poisson's ratio</b>	0.2

A soil investigation was performed at the field test location. The boring log results can be found in the Appendix C. Analyzing the boring, the native soil for the trench wall is composed of a thin layer of fill, an approximately 8 ft. layer of sandy lean clay, 4ft. layer of limestone, and a final layer of lean clay where the investigation stopped at depth of 15ft. The general trench wall profile is illustrated in the Figure 3-3.

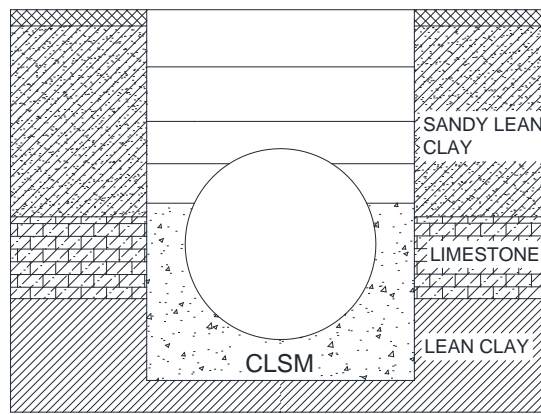

Figure 3 - 3 Trench soil and installation profile

Defining the trench wall soil is important for the finite element analysis of narrow trenches, since the stiffness of the adjacent wall influence the soil-pipe stiffness system that resists to the deflection due to external loads. The finite element model is capable of considering the effect of the trench wall.

For the field test the native soil is also used as embedment and backfilling material of the trench. Thus, the soil properties entered for the trench wall and embedment soil are the same. The soil properties for sandy lean clay are summarized in the Table 8. The soil was modeled using the Mohr Coulomb Model and the triaxial test results are in the Appendix D.

Table 8 Native Soil Properties

<b>Density</b>	120 pcf
<b>Modulus of Elasticity</b>	700 psi
<b>Poisson's ratio</b>	0.3
<b>Friction Angle</b>	23.6
<b>Cohesion</b>	514.5 pcf
<b>Dilantacy Angle</b>	6.4

### 3.2.5 Staged Construction

The finite element model considers the staged construction reproducing the trench installation. The first analysis step is pipe placement in the CLSM in which the pipe and the CLSM weight are the loads acting on the model. Next, the layers of soil are added to the system in separate analysis steps (the soil layer height of approximately 1ft. followed the construction lift). For the layers of soil, gravity and compaction load are also applied. As a fifth and sixth analysis step, the backfilling soil layers are applied to the pipe.

For modeling the staged construction the procedure described by Dezfooli (2013) was followed and the algorithm of activation and de-activation of the layer was used. Figure 3-4 illustrates CLSM and three layers in contact with pipe in the step that only pipe and CLSM are activated in the model. The shared nodes allow the part to capture and track the modified geometry according to the deformed shape of the neighbor part, and the shared nodes with pipe will deform and track the modified geometry.

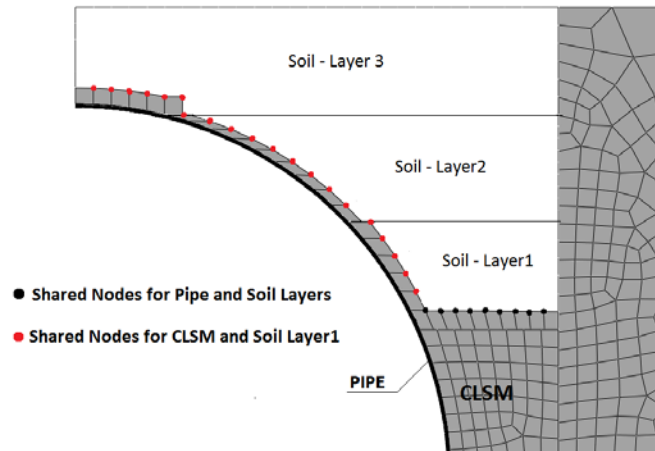

Figure 3 - 4 Nodes shared between active and deactivated parts

### 3.2.6 Contact Modeling

In the analysis of buried pipes, it is important to allow movement (slip) between the layer of soil, and between the soil and the pipe. Reproducing the considerations made by Dezfooli (2013) models, the contact surfaces are illustrated in the Figure 3-5, where for pipe-soil, soil-soil (embedment and trench wall), and CLSM-soil, are the contact properties defined in the tangential and normal directions. The tangential behavior is defined by a friction coefficient which is selected according to literatures. Referring to El-Chazli et. al. (2006), the coefficient should be considered between 0.2 and 0.5. The normal contact is assumed to be a “Hard contact” that dictates that two contacting parts cannot penetrate into each other.

The interaction pipe-CLSM is considered to be tie constraint, where the displacement degrees of freedom are tied.

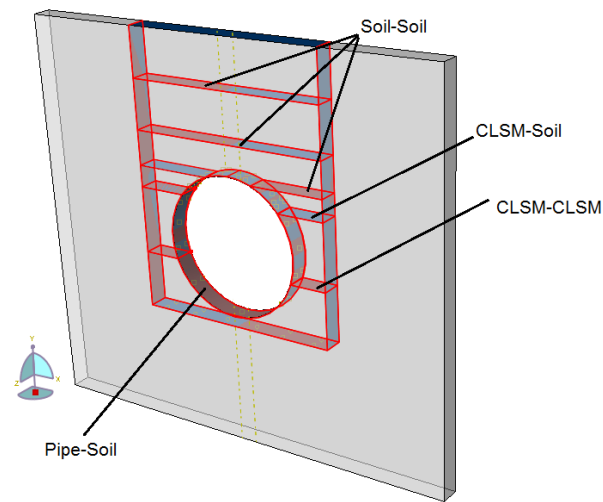

Figure 3 - 5 Surface Contact Modeling

### 3.2.7 Mesh Size and Element type

After assembling the finite element model, applying loads and boundary conditions, the model is seeded creating a mesh. Proper elements should be assigned to the parts and in this study the 8-nodded linear brick element with reduced integration is used for the soil and pipe elements.

### 3.3 Finite Element Results

For each of the field test pipes, a model is made and verified with the test results. The initial deflection of pipe due to its self-weight was not reported in the field test data, thus in the graphs for the finite element models, the initial deflection due to pipe self-weight is reduced from the data.

For each of the pipe, two cross sections in the pipes were instrumented for vertical and horizontal deflection. The analysis results of the finite element models are compared with the horizontal and vertical deflections obtained from the field test data, in each stage of construction.



Also, each pipe in the field test is instrumented with strain gauges to record strain variances during the construction. The finite element analysis results of the models are compared with the strain obtained from the field test data for the final stage of construction.

### 3.3.1 Deflections

The deflection results are illustrated in the Figure 3-6 to 3-8.

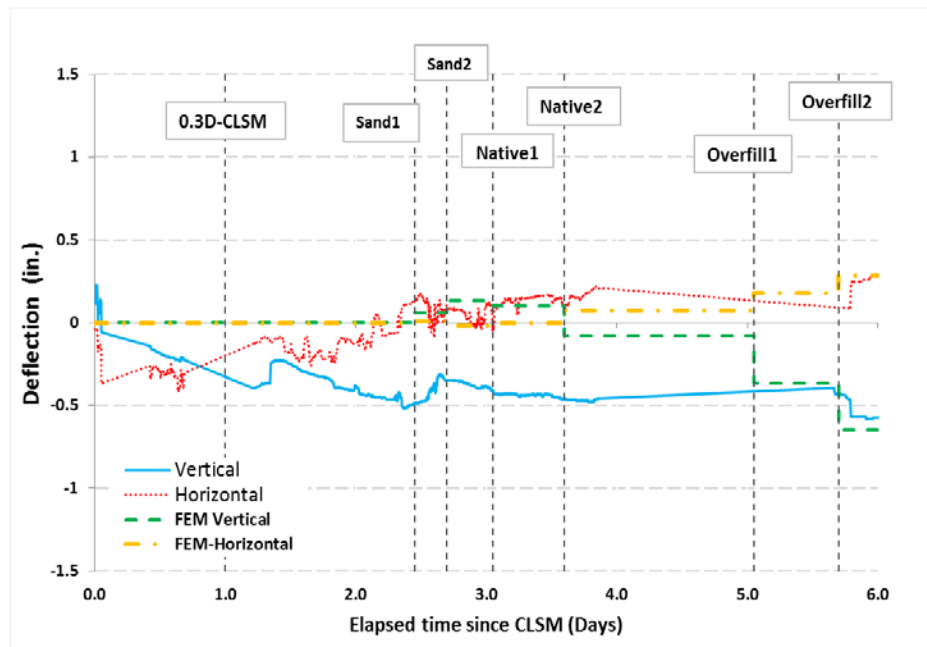

Figure 3 - 6 Pipe 1 Deflection: FEM vs. Field Test

The difference observed in the deflection for the finite element deflection and field test during the staged construction is related due to pipe flotation (described in the section 2.5.1). The finite element models present similar final deflections when compared to the field test.

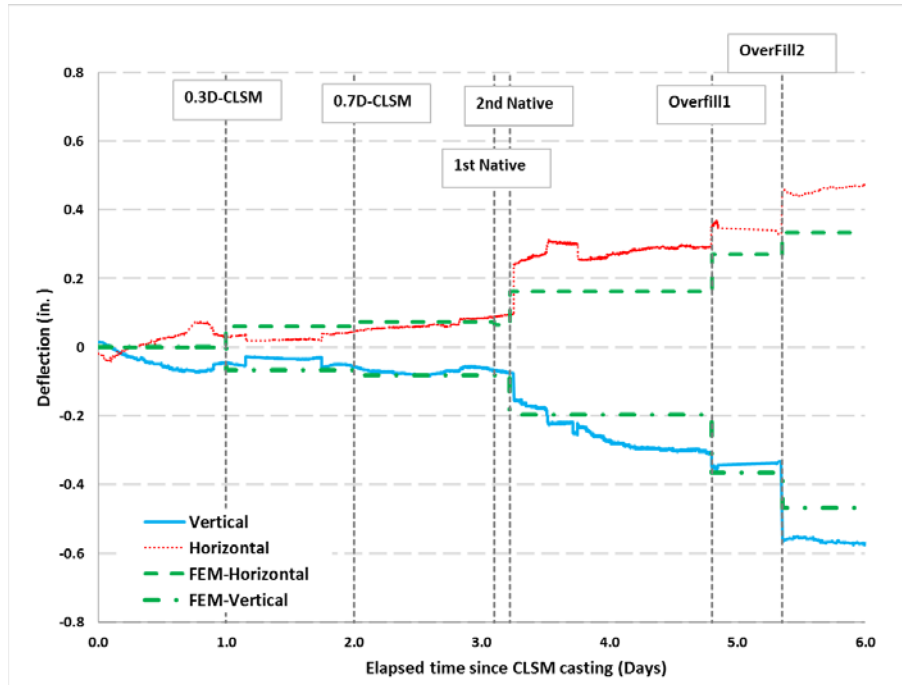

Figure 3 - 7 Pipe 2 Deflection: FEM vs. Field Test

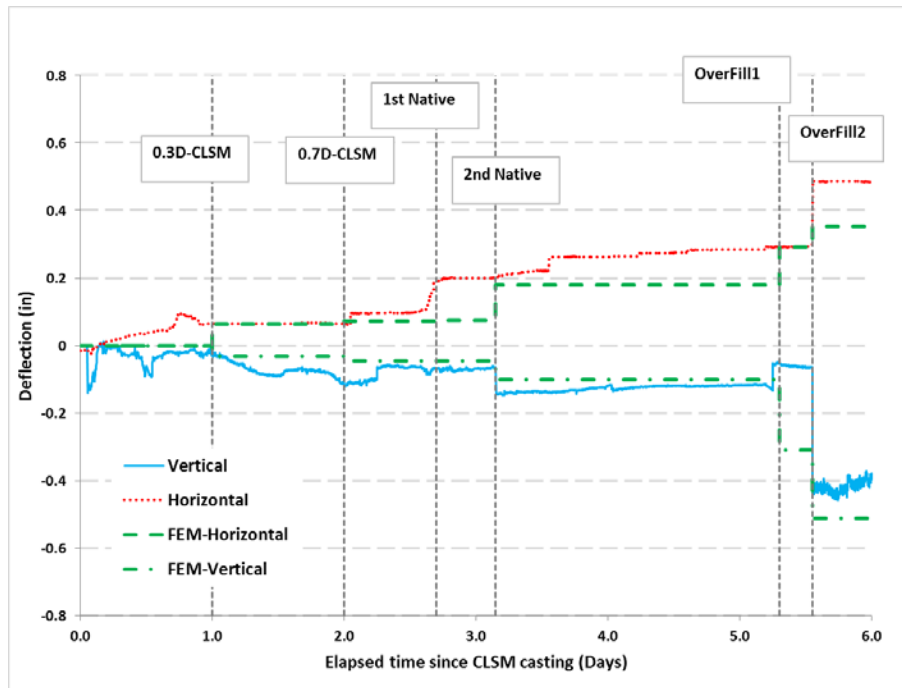

Figure 3 - 8 Pipe 3 Deflection: FEM vs. Field Test

Figure 3-7 to 3-9 illustrate the finite element models results for the different trench geometry configuration at the section 1 and section 2 for each pipe.

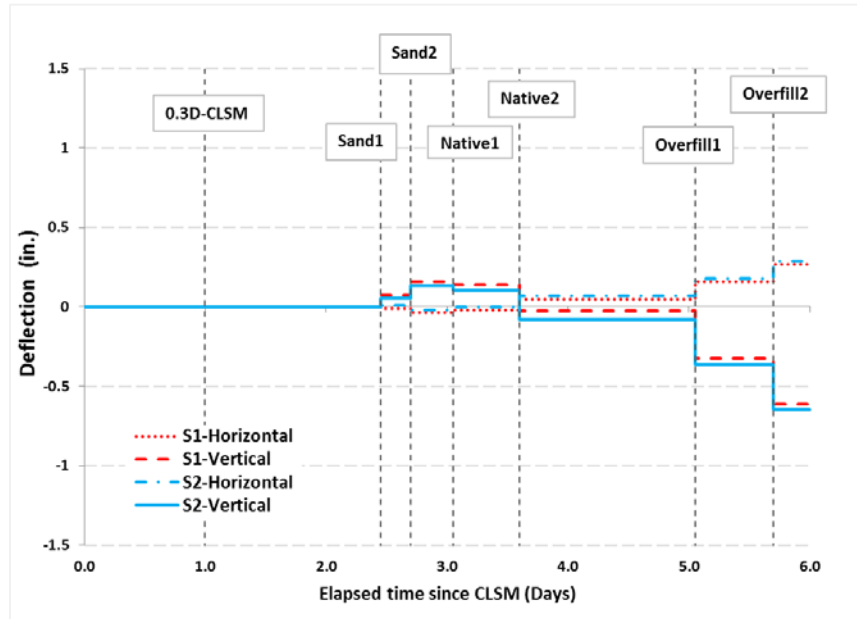

Figure 3 - 9 Pipe 1 Deflection: FEM Section 1 vs. FEM Section 2

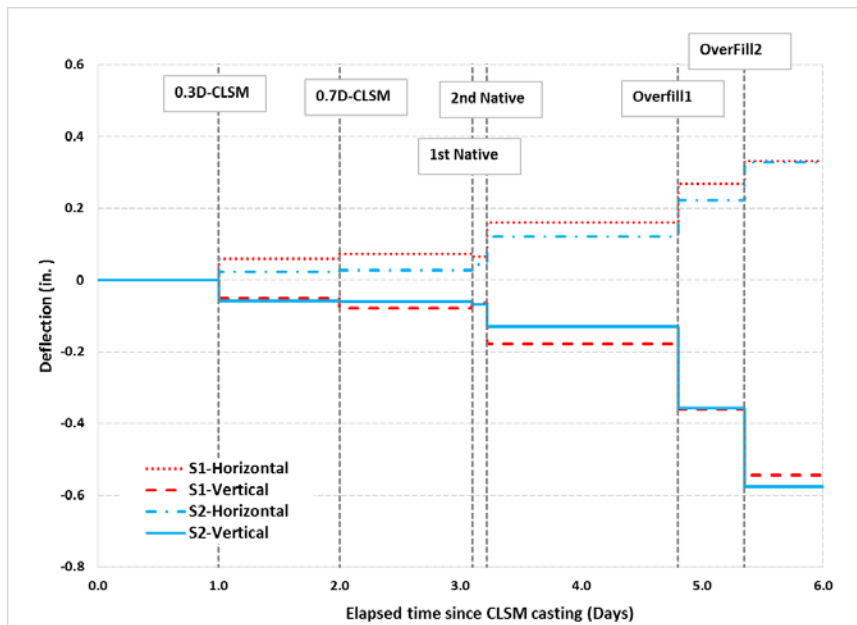

Figure 3 - 10 Pipe 2 Deflection: FEM Section 1 vs. FEM Section 2

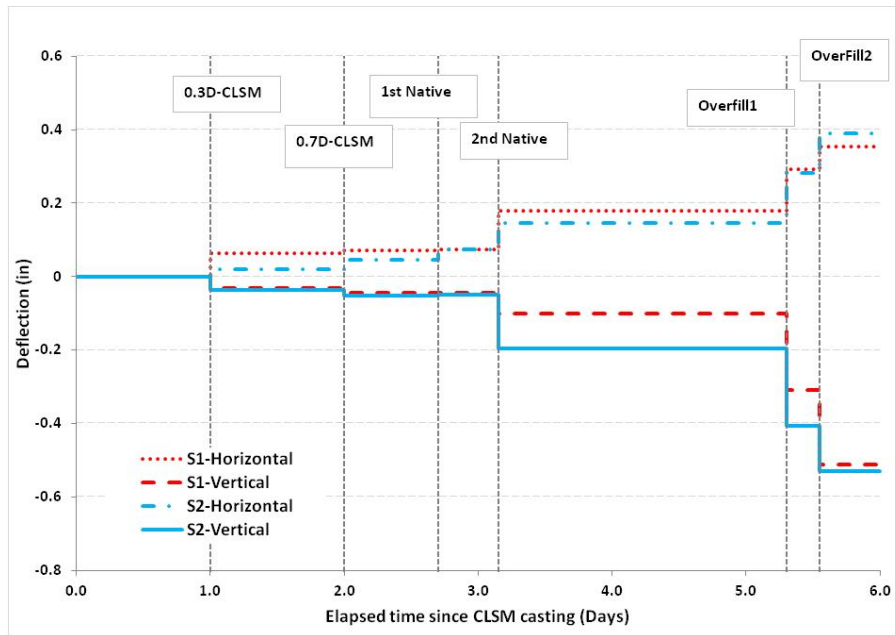

Figure 3 - 11 Pipe 3 Deflection: FEM Section 1 vs. FEM Section 2

### 3.3.2 Strains

The finite element analysis results of the models are compared with the strain obtained from the field test data for the final stage of construction. The field test results for strains compared with the finite element models were taken at approximate 20 days of the test duration. At 20 days the data seems to be stable and not affected by humidity and water that was accumulated inside the pipe after torrential rain in the region. The finite element strains are calculated using Hook's Law, based on the stresses in the pipe that remain in the elastic stage.

Figure 3-8 to 3-10 illustrate the strain results. The finite element data are shown for the locations: crown, invert, spring line (in), and spring line (out) at the last stage of the construction for the three pipes. Positive values indicate tension and negative indicate compression on the steel pipe wall.

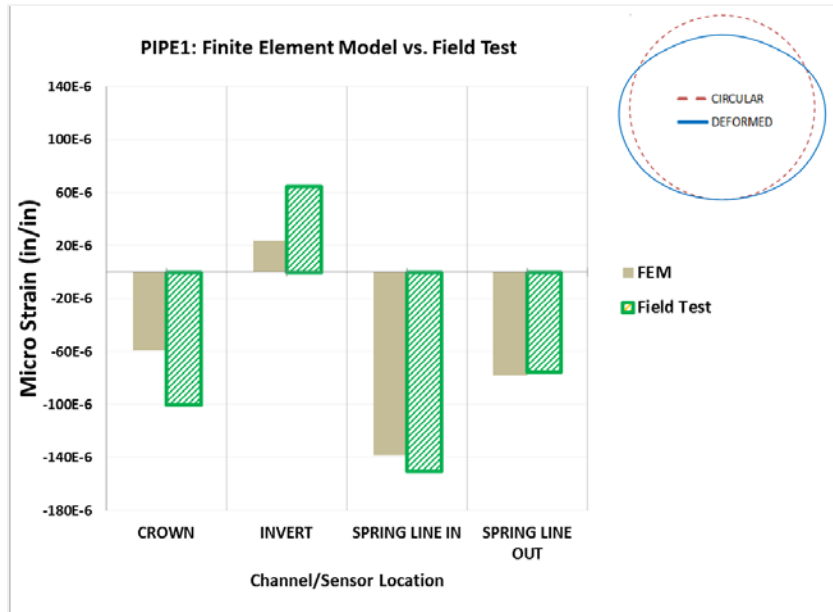

Figure 3 - 12 Pipe 1 Strains: FEM vs. Field Test

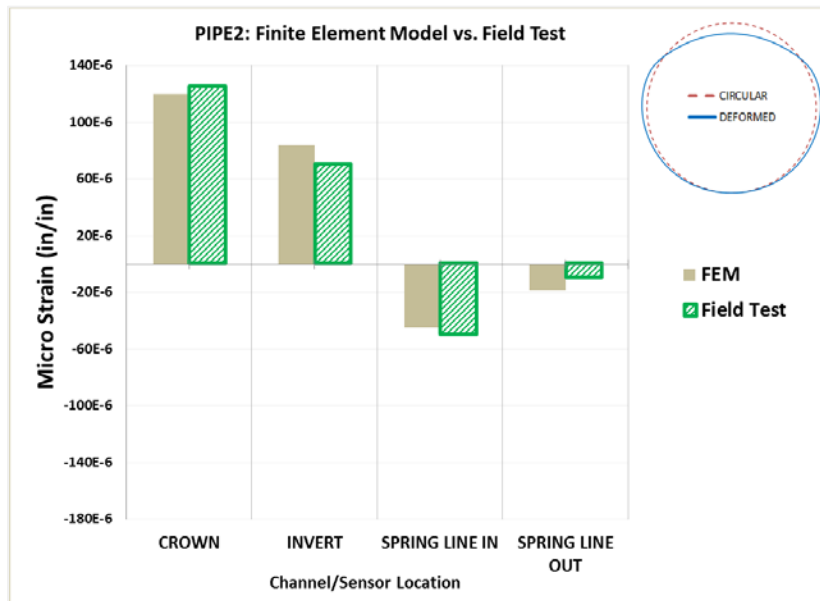

Figure 3 - 13 Pipe 2 Strains: FEM vs. Field Test

The finite element results are compatible with the field test and present difference in the result of Pipe 3, Figure 3-14. These discrepancies may be cause by the CLSM

leaking inside the pipe, affecting the invert recording, or by the mal function of the strain gauges (Spring Line-in).

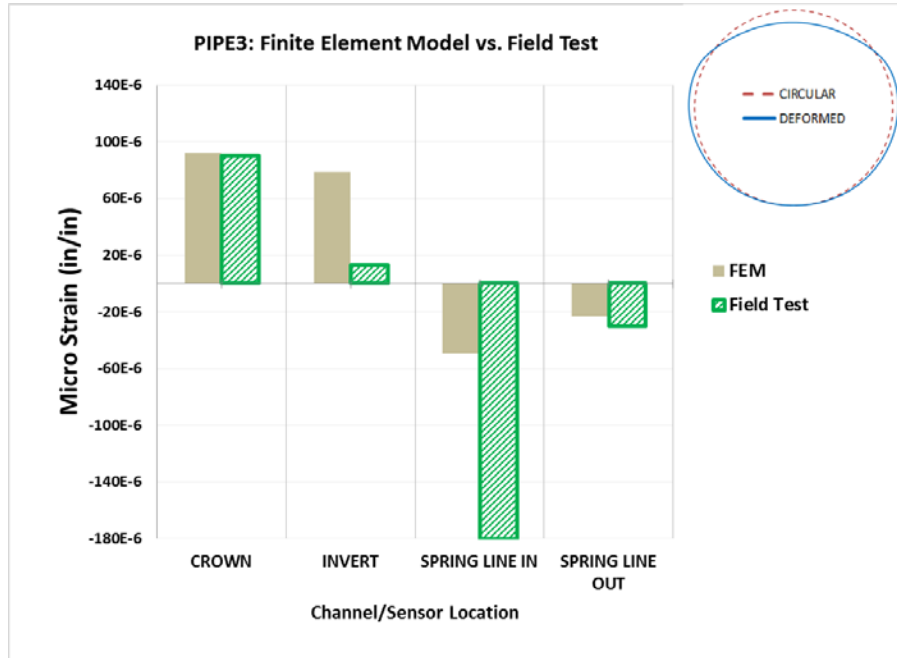

Figure 3 - 14 Pipe 3 Strains: FEM vs. Field Test

### 3.4 Finite Element Model Verifying

After the finite element model results are compared with the field test of the three pipes, a set of different models are created to verify the finite element model for different trench conditions. Similarly to the field test the deflection of a 108 in. outside diameter pipe with thickness of 0.470 in. is modeled under different trench geometry and materials conditions.

The models present CLSM to the depth of 0.3, 0.5 and 0.7 O.D. and the trench width varies from O.D. plus 24 in. to O.D. plus 216 in. For the trench wall, different soil stiffness is considered and three different soil Young's Modulus are analyzed: soft (300 psi), moderate (1500 psi) and stiff (5000 psi).

Figure 3-15 show the results for the vertical displacements at the last construction stage for a backfilling height of approximate 12 ft. The sixty three models created represent a small parametric study to verify the finite element model.

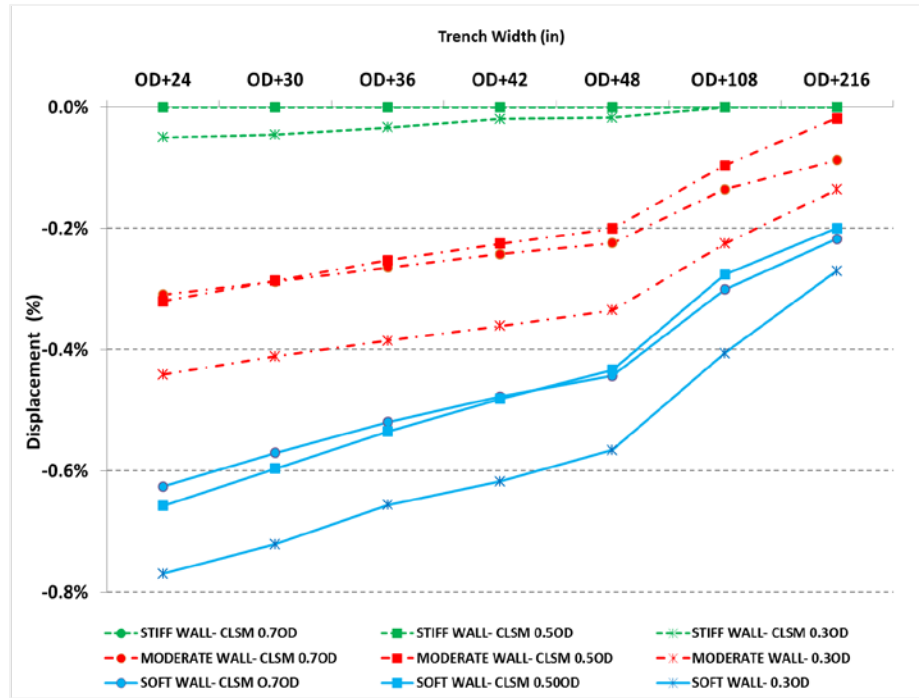

Figure 3 - 15 Vertical displacement for a 108 in. diameter pipe

Analyzing the results above, the finite element model predicts that a narrow trench provides less restraint than a wider trench. Also, it recognizes that a trench adjacent to a soft soil trench wall provides less restraint as if was adjacent to a stiff trench wall.

Analyzing the CLSM depths, the finite element model also reproduces that the pipes present more deflection in a trench with CLSM of 0.3 O.D. depths than in a trench with CLSM depth of 0.5 O.D. The same occurs when comparing the pipes with CLSM 0.5 O.D. to CLSM 0.7 O.D., the pipes present more deflection with a lower depth than with a larger depth.

## Chapter 4

### Summary, Conclusion, and Recommendation

#### 4.1 Summary

This study is aimed to evaluate the structural performance of selected steel pipes coupled with Controlled Low Strength Material (CLSM) for the Integrated Pipeline Project (IPL). A nonlinear three dimensional finite element model for steel pipes coupled with CLSM was developed and is capable to simulate the performance of buried steel pipes. To verify the finite element model, the field test was performed recording the pipe performance during trench construction. Also, the field test monitored the long-term pipe behavior recording up to 350 days, the pipe deflection.

The field instrumentation monitors the displacements and circumferential strains of three buried steel pipes with an outside diameter (O.D.) of 84 in. and 0.375 in. thickness in three different trenches using controlled low strength material (CLSM). For the first case, the trench width is 120 in. (O.D. plus 36 in.), and CLSM is used as embedment up to 30% of the O.D. In the second case, the trench width is 120 in. (O.D. plus 36 in.), and CLSM is used as embedment up to 70% of the O.D. In the third case, the trench width is 102 in. (O.D. plus 18 in.), and CSLM is used as embedment up to 70% of the O.D. From the CLSM to the top of the pipe, local soil (Lean Clay) is used and compacted to 95% standard proctor density. Also, 5ft.of backfilling is added for all cases. For pipe structural monitoring two sections for each pipe (at 1/3 of the pipe length), with seven strain gages are attached inside and one outside of the pipe to obtain the circumferential strain, and displacement transducers are installed to record vertical and horizontal diameter displacement. The deflections of the steel pipes are measured in each of the construction stages: the CLSM embedment, the soil compaction, and during



the load of the 5ft soil on top of the pipe. Furthermore, the buried pipes are monitored for 350 days to record the long term vertical and horizontal deflection of the pipes.

A three dimensional (3D) nonlinear finite element model of steel pipe coupled with CLSM and compacted soil was developed. The finite element model consists of the pipe and soil interaction during the staged construction of embedment and backfill. The model loads contain the self-weight of the backfilling soil, the at rest lateral pressure and the lateral effect of soil compaction. The material properties of the local soil, steel pipe, and CLSM were modeled based on unconfined compressive strength test for CLSM, and boring logs soil investigation for the local soil. The finite element model developed simulates the deformation of the buried steel pipes and was verified by the field test results.

#### 4.2 Conclusion

Throughout this study, experimental field test and finite element analysis were performed to evaluate the performance of selected steel pipes coupled with CLSM.

The field test successfully acquired vertical and horizontal pipe diameter displacement and circumferential strains. The displacements and strains are important to verify the finite element model developed. The recorded data includes the influence of the soil stiffness of the adjacent trench wall and compaction forces on the pipe.

The field test for Pipe 1 with trench width of 120 in., and CLSM as embedment up to 30% of the O.D., present results for vertical displacements at last construction stage of approximately 0.62 in. The horizontal displacement is approximately 0.35 in. These results are based on section 2, since the monitoring during construction of section 1 was affected by CLSM leaking inside the pipe. The deflection during staged construction did not present significant difference when the struts were removed after the placement of the second native soil layer, confirming that CLSM and compacted soil provided the

required stiffness to support the pipe. After the trench installation was finished, the displacements were recorded for approximately 25 days and show small increase with time. The results present disturbances that are related to rain that drained into the pipe during the long term monitoring. The field test was interrupted after 25 days of recording due to torrential rain that flooded water into the pipe. After several attempts of keeping the water out the pipe, approximately 5 months after the field test was interrupted, the water was pumped out the pipe and concrete vaults, and the displacement transducers were repaired and reinstalled. The field test recording restarted after 150 days of elapsed time of construction, and pipe vertical and horizontal displacements present an increase with time; however the deflections are under 2% O.D deflection limit. This deflection increment is due to soil saturation increasing the soil self-weight, consequently increasing the load on the pipe. Also, further CLSM investigation is recommended since the water may influence its strength, affecting pipe support.

For Pipe 1, the three-dimensional finite element model predicts the displacement (vertical and horizontal) of the steel pipe, modeling staged construction. The finite element model developed, reproduced deflection and strains results simulating the trench staged construction and in-situ trench conditions. The finite element models for section 1 and 2 present similar results, since the models were based on the surveying geometry. The deflection results are concurrent with the field test results.

The strain gauges presented recordings of compression and tension forces on the pipe wall. Figure 4-1 illustrates the deflected pipe shape of the finite element model (factored 25 times) and the stresses on the pipe wall. All the strains in the finite element model are elastic, thus Hook's Law is applied to find the strains to be compared with field test results. The field test strain results are concurrent with the finite element results.

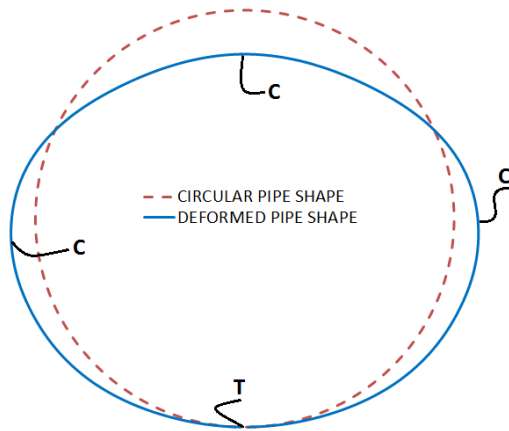

Figure 4 – 1 Pipe 1: Deformed Shape and Wall Stresses

For Pipe 1 the finite element model successfully predicted the deflections and circumferential strains of field test based on section 2.

The field test for Pipe 2 with trench width of 120 in., and CLSM as embedment up to 70% of the O.D., present results for vertical displacements at last construction stage of on average 0.48 in. The horizontal displacement is approximately 0.35 in. These results are average of section 1 and section 2. The deflection during staged construction, also did not present significant difference when the struts were removed after the placement of the second native soil layer, confirming that CLSM and compacted soil provided the required stiffness to support the pipe. After the trench installation was finished, the displacements were recorded for approximately 25 days and show small increase with time. The results present disturbances that are related to rain that drained into the pipe during the long term monitoring. The field test was interrupted after 25 days of recording due to torrential rain that flooded water into the pipe. After several attempts of keeping the water out the pipe, approximately 5 months after the field test was interrupted, the water was pumped out the pipe and concrete vaults, and the displacement transducers were repaired and reinstalled. The field test recording restarted after 150 days of elapsed

time of construction, and pipe vertical and horizontal displacements present an increase with time; however the deflections are under 2% O.D deflection limit. The same conclusions described for Pipe 1 for the deflection increment due to soil saturation is applied for Pipe 2.

For Pipe 3, the three-dimensional finite element model predicts the displacement (vertical and horizontal) of the steel pipe, modeling staged construction. The finite element model developed, reproduced deflection and strains results simulating the trench staged construction and in-situ trench conditions. The finite element models for section 1 and 2 present similar results, since the models were based on the surveying geometry and present different geometry. The deflection results are concurrent with the field test results; comparing Pipe1 with Pipe 2 deflections, the trench with CLSM up to 70% O.D. provides more restraint, consequently less pipe deflection.

The strain gauges presented recordings of compression and tension forces on the pipe wall. Figure 4-2 illustrates the deflected pipe shape of the finite element model (factored 25 times) and the stresses on the pipe wall. All the strains in the finite element model are elastic. The field test strain results are similar to the finite element results.

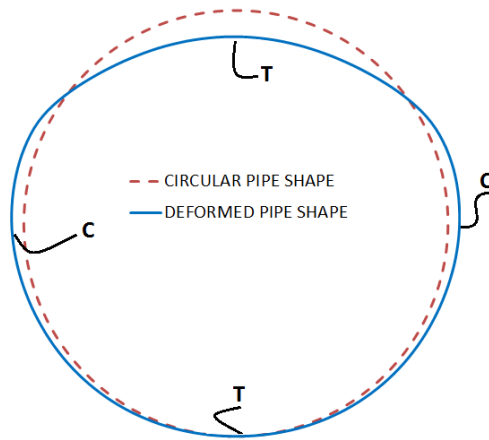

Figure 4 – 2 Pipe 2: Deformed Shape and Wall Stresses

The field test for Pipe 3 with trench width of 102 in, and CLSM as embedment up to 70% of the O.D., present results for vertical displacements at last construction stage of on average 0.53 in. The horizontal displacement is approximately 0.38 in. These results are average of section 1 and section 2. The deflection during staged construction, also did not present significant difference when the struts were removed after the placement of the second native soil layer, also confirming that CLSM and compacted soil provided the required stiffness to support the pipe. After the trench installation was finished, the displacements were recorded for approximately 25 days and show small increase with time. The results present disturbances that are related to rain that drained into the pipe during the long term monitoring. The field test was interrupted after 25 days of recording due to torrential rain that flooded water into the pipe. After several attempts of keeping the water out the pipe, approximately 5 months after the field test was interrupted, the water was pumped out the pipe and concrete vaults, and the displacement transducers were repaired and reinstalled. The field test recording restarted after 150 days of elapsed time of construction, and pipe vertical and horizontal displacements present an increase with time; however the deflections are under 2% O.D deflection limit. The same conclusions described for Pipe 1 and 2 for the deflection increment due to soil saturation are applied for Pipe 3.

For Pipe 3, the three-dimensional finite element model predicts the displacement (vertical and horizontal) of the steel pipe, modeling staged construction. The finite element model developed, reproduced deflection and strains results simulating the trench staged construction and in-situ trench conditions. The finite element models for section 1 and 2 present similar results, since the models were based on the surveying geometry and present different geometry. The deflection results are concurrent with the field test

results; comparing Pipe 3 with Pipe 2 deflections, the wider trench with CLSM up to 70% O.D. provides more restraint, consequently less pipe deflection.

The strain gauges presented recordings of compression and tension forces on the pipe wall. Figure 4-3 illustrates the deflected pipe shape of the finite element model (factored 25 times) and the stresses on the pipe wall. All the strains in the finite element model were also elastic. The field test strain results are similar to the finite element results.

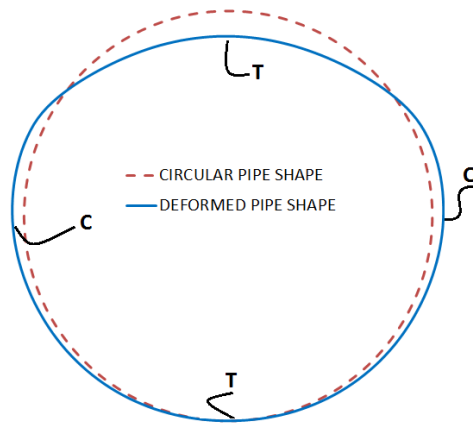

Figure 4 – 3 Pipe 3: Deformed Shape and Wall Stresses

Comparing deflection results of Pipe 1 and Pipe 2, Pipe 2 presents less deflection than Pipe 1 because of the superior support provided by the CLSM. Comparing deflection results of Pipe 2 and Pipe 3 have the same CLSM depth, Pipe 2 presents less deflection than Pipe 3. Thus, the finite element model predicts that the pipe coupled with CLSM under vertical load in a narrow trench deflects more than in a wider trench. Based on based on the model verifying results, where the wall stiffness was varied form soft, moderate, and stiff, the finite element model recognizes that a trench next to a soft soil wall provides less restraint as if it was next to a stiff trench wall.

Using the finite element model developed in this study, many different trench conditions can be analyzed. Different trench conditions can be modeled by varying the pipe diameter, the height of the CLSM, the in-situ soil stiffness for the trench wall, the trench width, soil material, etc. The use of CLSM has many advantages over traditional embedment materials, and a finite element analysis is an important tool in predicting the pipe deflection when using this material that is becoming widely used in trench installations.

#### 4.3 Recommendation

The recommendations for future research studies are:

1. Excavate the field test trench to analyze if the CLSM presents cracks and if the compressive strength was reduced, compromising the support of the pipes.
2. A durability investigation is recommended to investigate the effect of water in the material properties of the CSLM.
3. Additional tests can be performed in the field test including the effect of live load.
4. For the finite element models, a stress analysis for the CLSM and for the soil surrounding the pipes is recommended.
5. The finite element models could be expanded to simulate the internal pressure of the water inside the pipes.
6. The finite element models can include the pipe lining and coating.

Appendix A

Unconfined Compressive Strength Test Results for Controlled Low Strength Material

By Fugro Consultants, Inc.



FUGRO UNCONFINED CLS.M FUGRO DATA TEMPLATE 100610.GDT FUGRO LIBRARY 08212 (LOKT).GLB (PROJECT FILES\PROJECTS\2011\1-10-12 PL PHASE 2\WISOM\44011-10-12.GPJ mjw\123112

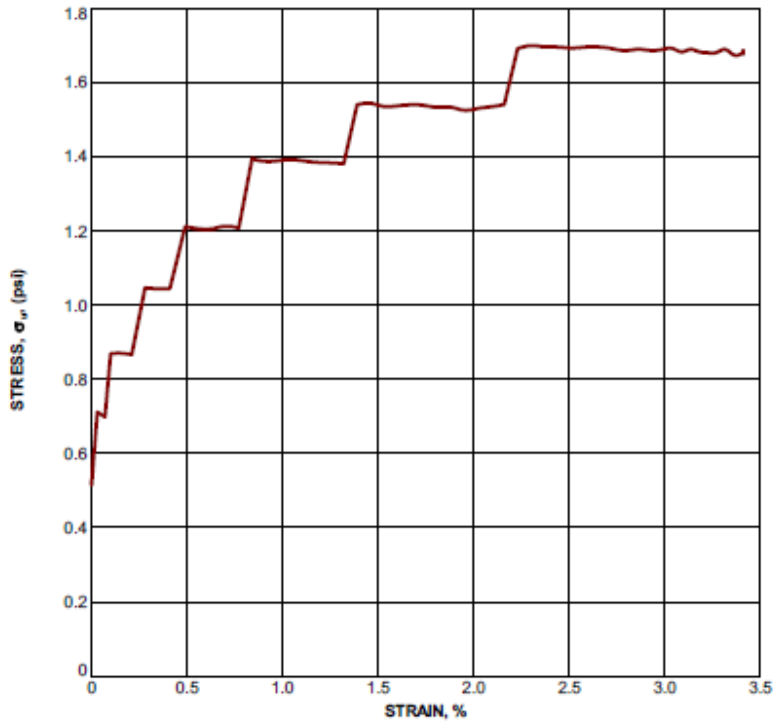

Sample No.:	UTA1-10
Remarks:	Native
Sample Type:	Flowable Fill
Admixture:	10% Cement
Cure Time, (days):	1
Unconfined Compression Strength, $\sigma_v$ , (psi):	1.70
Undrained Shear Strength, $S_u$ , (psi):	0.85
Strain at Failure, (%):	2.30
Young's Modulus, $E_{1\%}$ , (psi):	347
Strain Rate, (%/min):	0.44
Total Density, (pcf):	111.8
Specimen Diameter, d (in.):	6.00
Specimen Height, h (in.):	12.00
Height/Diameter Ratio:	2.00
Specific Gravity, Gs:	(Assumed) 2.75



<b>INTEGRATED PIPELINE PROJECT</b>		<b>UNCONFINED COMPRESSION TEST RESULT</b>		
<b>Tarrant Regional Water District</b>		<b>ASTM D 4832</b>		
Tested By: Teodor Petkov	Date Tested: 11/6/2012	Checked By: Jaime Reyes	Project No. 04.4011-1012	<b>PLATE F - 10</b>

FUGRO UNCONFINED CLSM FUGRO DATA TEMPLATE 10/6/10.GDT FUGRO LIBRARY 03/21/12 10:00:01.GLB 1:PROJECT FILES\PROJECTS\041111-1012 PI PHASE 2\MI\SD044011-1012.GPJ revised 12/1/12

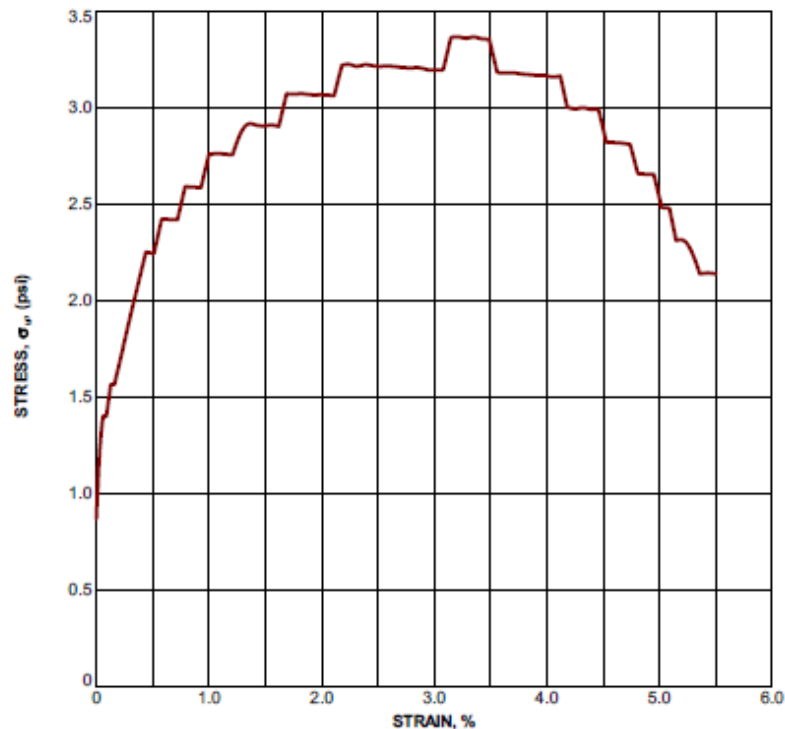

Sample No.:	UTA1-10
Remarks:	Native
Sample Type:	Flowable Fill
Admixture:	10% Cement
Cure Time, (days):	1
Unconfined Compression Strength, $\sigma_{uc}$ (psi):	3.36
Undrained Shear Strength, $S_u$ (psi):	1.68
Strain at Failure, (%):	3.22
Young's Modulus, $E_{30}$ (psi):	243
Strain Rate, (%/min):	0.69
Total Density, (pcf):	104.9
Specimen Diameter, d (in.):	6.00
Specimen Height, h (in.):	12.00
Height/Diameter Ratio:	2.00
Specific Gravity, Gs:	(Assumed) 2.75



 Fugro Consultants, Inc	<b>INTEGRATED PIPELINE PROJECT</b>		<b>UNCONFINED COMPRESSION TEST RESULT</b>		
	<b>Tarrant Regional Water District</b>			ASTM D 4832	
	Tested By: Teodor Petkov	Date Tested: 11/6/2012	Checked By: Jalme Reyes	Project No. 04.4011-1012	<b>PLATE F - 11</b>

FUGRO UNCONFINED CLSM FUGRO DATA TEMPLATE 100610.GDT FUGRO LIBRARY 02212.LOKY.GLB \PROJECT FILES\PROJECTS\2011\1-10\2 PL PHASE 2\WIS\044011-10\2.GPJ myvel 1/23/12

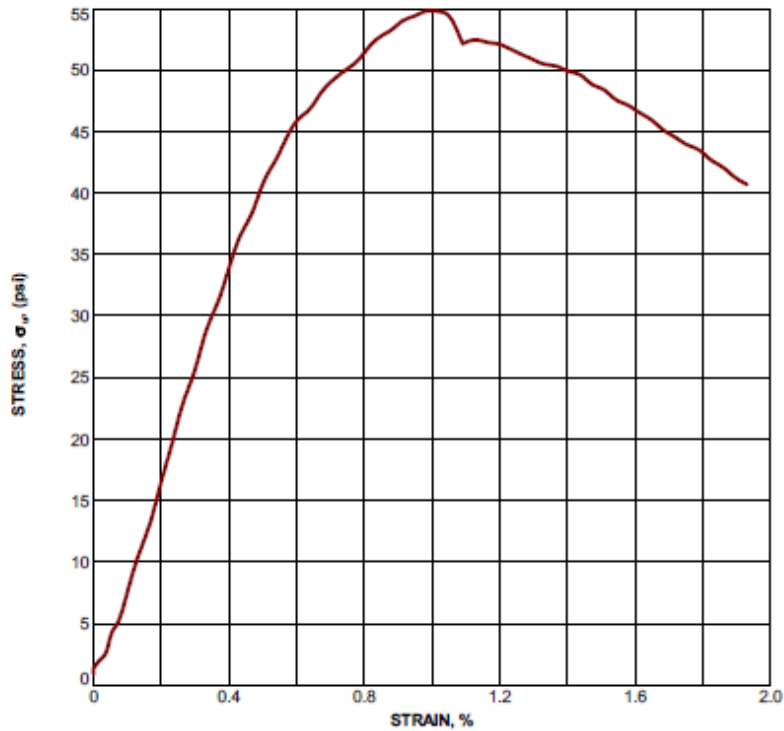

**Failure Description**

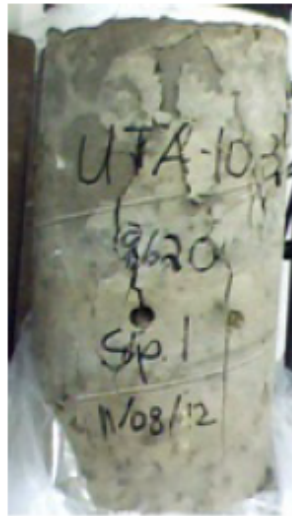

Sample No.:	UTA1-10
Remarks:	Native
Sample Type:	Flowable Fill
Admixture:	10% Cement
Cure Time, (days):	3
Unconfined Compression Strength, $\sigma_u$ , (psi):	54.77
Undrained Shear Strength, $S_u$ , (psi):	27.39
Strain at Failure, (%):	0.98
Young's Modulus, $E_{TSP}$ , (psi):	8861
Strain Rate, (%/min):	0.34
Total Density, (pcf):	108.0
Specimen Diameter, d (in.):	6.00
Specimen Height, h (in.):	12.00
Height/Diameter Ratio:	2.00
Specific Gravity, Gs:	(Assumed) 2.75



**INTEGRATED PIPELINE PROJECT**

**UNCONFINED COMPRESSION TEST RESULT**

**Tarrant Regional Water District**

ASTM D 4832

Tested By:  
Teodor Petkov

Date Tested:  
11/9/2012

Checked By:  
Jaime Reyes

Project No.  
04.4011-1012

**PLATE F - 12**

FUGRO UNCONFINED CLSM FUGRO DATA TEMPLATE 100610.GDT FUGRO LIBRARY 02/21/12 (L:\OVT\GLB \PROJECT FILES\PROJECTS\2011\1-10-12 PL PHASE 2\MS\04-4011-10-12.GPJ myref 12/1/12

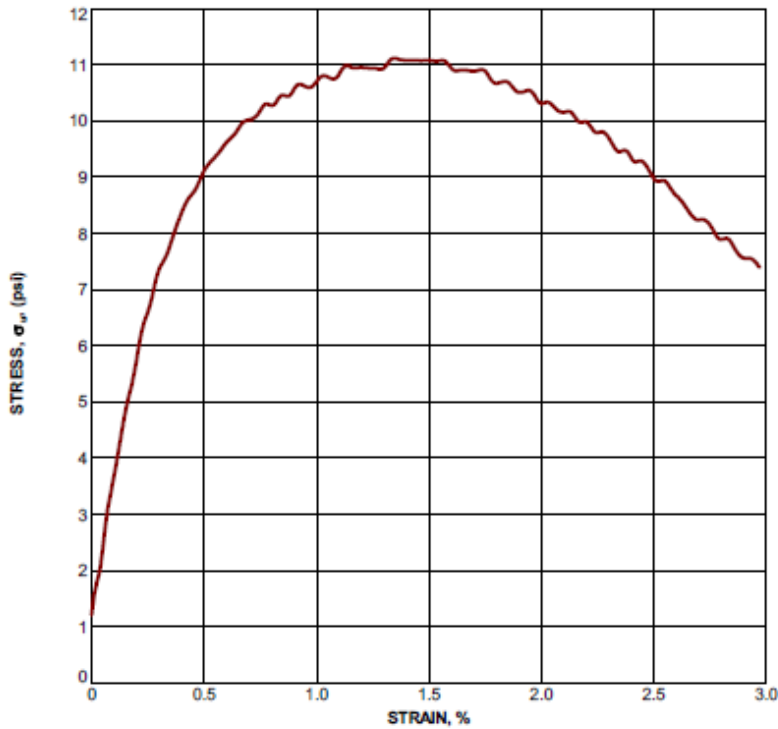

Sample No.:	UTA1-10
Remarks:	Native
Sample Type:	Flowable Fill
Admixture:	10% Cement
Cure Time, (days):	5
Unconfined Compression Strength, $\sigma_u$ (psi):	11.09
Undrained Shear Strength, $S_u$ (psi):	5.54
Strain at Failure, (%):	1.37
Young's Modulus, $E_{750}$ (psi):	2002
Strain Rate, (%/min):	0.35
Total Density, (pcf):	22.5
Specimen Diameter, d (in.):	6.00
Specimen Height, h (in.):	12.00
Height/Diameter Ratio:	2.00
Specific Gravity, Gs:	(Assumed) 2.75

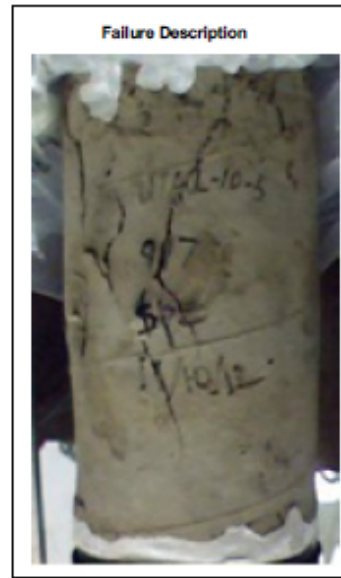

**INTEGRATED PIPELINE PROJECT**

**UNCONFINED COMPRESSION TEST RESULT**

**Tarrant Regional Water District**

ASTM D 4832

Tested By:  
Teodor Petkov

Date Tested:  
11/10/2012

Checked By:  
Jaime Reyes

Project No.  
04.4011-1012

**PLATE F - 13**

FUGRO UNCONFINED CLSM FUGRO DATA TEMPLATE 100616.GDT FUGRO LIBRARY 082212.LOKT.GLB PROJECT FILES\PROJECTS\2011\15-1012 P.I. PHASE 2\MS\SC0044011-1012.GPJ rev.04 12/21/12

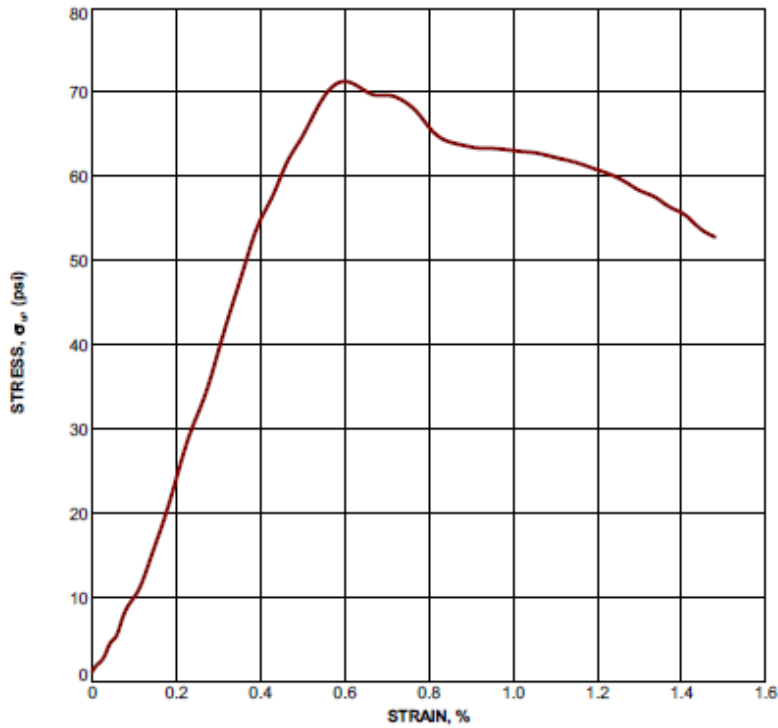

Sample No.:	UTA1-10
Remarks:	Native
Sample Type:	Flowable Fill
Admixture:	10% Cement
Cure Time, (days):	7
Unconfined Compression Strength, $\sigma_v$ (psi):	71.28
Undrained Shear Strength, $S_u$ (psi):	35.64
Strain at Failure, (%):	0.60
Young's Modulus, $E_{TSP}$ (psi):	15905
Strain Rate, (%/min):	0.34
Total Density, (pcf):	111.1
Specimen Diameter, d (in.):	6.00
Specimen Height, h (in.):	12.00
Height/Diameter Ratio:	2.00
Specific Gravity, Gs:	(Assumed) 2.75

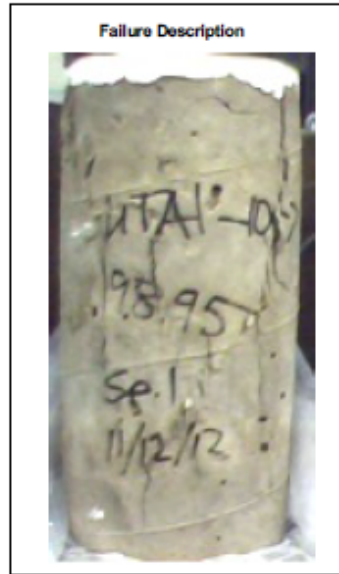

<b>INTEGRATED PIPELINE PROJECT</b>		<b>UNCONFINED COMPRESSION TEST RESULT</b>	
<b>Tarrant Regional Water District</b>		ASTM D 4832	
Tested By: Teodor Petkov	Date Tested: 11/12/2012	Checked By: Jalme Reyes	Project No. 04.4011-1012
			<b>PLATE F - 14</b>

FUGRO UNCONFINED CLSM FUGRO DATA TEMPLATE 100610.GDT FUGRO LIBRARY 03/21/12 (LONK) GLOB I:\PROJECT FILES\PROJECTS-2011\11-1012 PL PHASE 2\MISC04-0111-1012.GPJ reynol 12/11/12

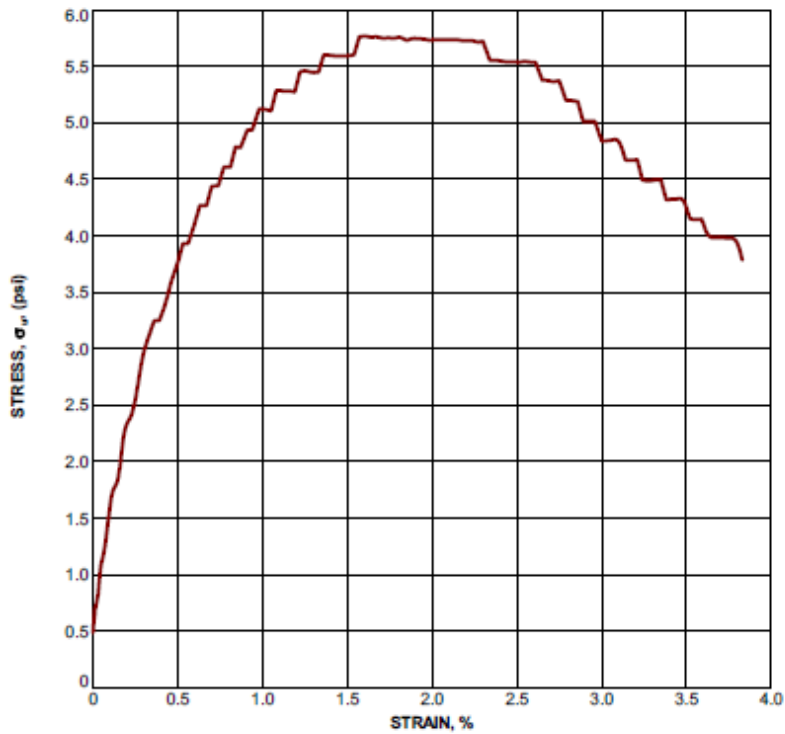

Sample No.:	UTA1-10
Remarks:	Native
Sample Type:	Flowable Fill
Admixture:	10% Cement
Cure Time, (days):	7
Unconfined Compression Strength, $\sigma_u$ , (psi):	5.76
Undrained Shear Strength, $S_u$ , (psi):	2.88
Strain at Failure, (%):	1.61
Young's Modulus, $E_{TC}$ , (psi):	627
Strain Rate, (%/min):	0.35
Total Density, (pcf):	104.0
Specimen Diameter, d (in.):	6.00
Specimen Height, h (in.):	12.00
Height/Diameter Ratio:	2.00
Specific Gravity, Gs:	(Assumed) 2.75

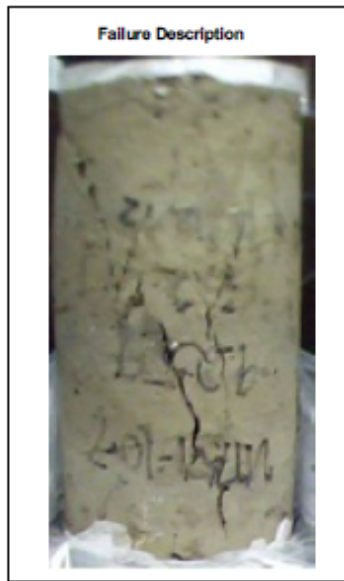

<b>INTEGRATED PIPELINE PROJECT</b>		<b>UNCONFINED COMPRESSION TEST RESULT</b>	
<b>Tarrant Regional Water District</b>		<b>ASTM D 4832</b>	
Tested By: Teodor Petkov	Date Tested: 11/12/2012	Checked By: Jaime Reyes	Project No. 04.4011-1012
			<b>PLATE F - 15</b>

FUGRO UNCONFINED CLSM FUGRO DATA TEMPLATE 100610.GDT FUGRO LIBRARY 02/21/12 (LONT) GLOB (PROJECT FILES PROJECTS-2011) 11-10-12 PL PHASE 2M (92004401) 1-10-12.GPJ rev01 12/4/12

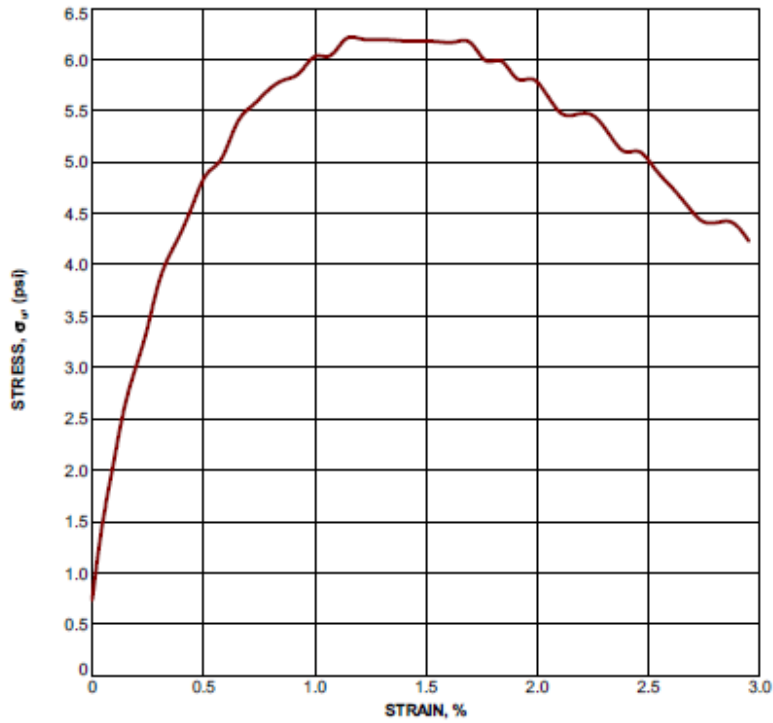

Sample No.:	UTA1-10
Remarks:	Native
Sample Type:	Flowable Fill
Admixture:	10% Cement
Cure Time, (days):	28
Unconfined Compression Strength, $\sigma_u$ (psi):	6.20
Undrained Shear Strength, $S_u$ (psi):	3.10
Strain at Failure, (%):	1.14
Young's Modulus, $E_{50}$ (psi):	1086
Strain Rate, (%/min):	0.69
Total Density, (pcf):	105.8
Specimen Diameter, d (in.):	6.00
Specimen Height, h (in.):	12.00
Height/Diameter Ratio:	2.00
Specific Gravity, Gs:	(Assumed) 2.75

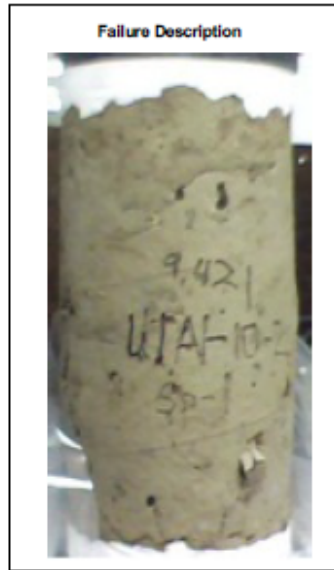

**INTEGRATED PIPELINE PROJECT**

**UNCONFINED COMPRESSION TEST RESULT**

**Tarrant Regional Water District**

ASTM D 4832

Tested By:  
Teodor Petkov

Date Tested:  
12/3/2012

Checked By:  
Jaime Reyes

Project No.  
04.4011-1012

**PLATE F - 16**

FUGRO UNCONFINED CLSM FUGRO DATA TEMPLATE 1001610.GDT FUGRO LIBRARY 08212 (L)OKT.GLB \PROJECT FILES\PROJECTS-2011\11-10-12 PL PHASE 2\1182044401-1-10-12.GPJ rev04 1/23/12

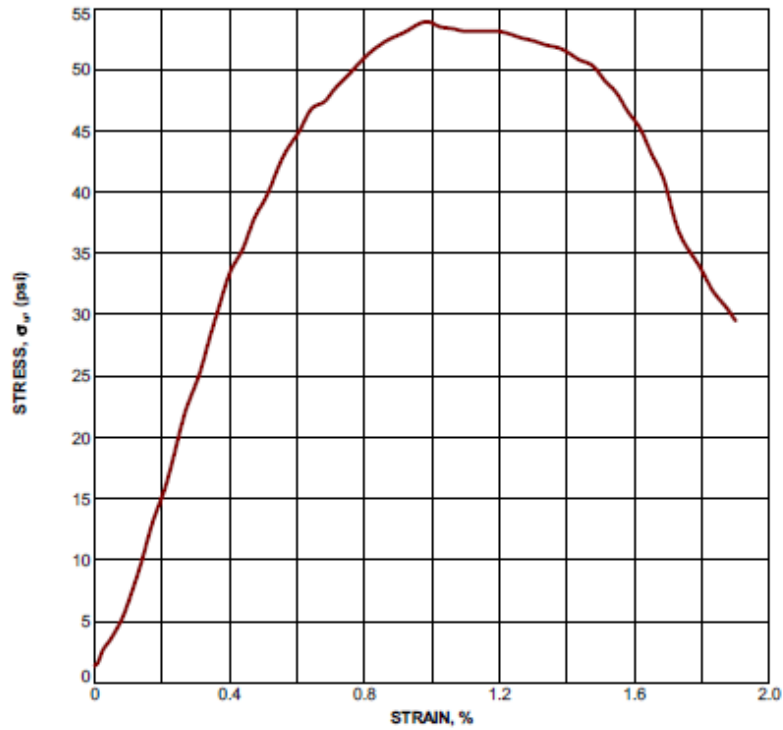

Sample No.:	UTA2-10
Remarks:	Native
Sample Type:	Flowable Fill
Admixture:	10% Cement
Cure Time, (days):	3
Unconfined Compression Strength, $\sigma_u$ , (psi):	53.88
Undrained Shear Strength, $S_u$ , (psi):	26.94
Strain at Failure, (%):	0.99
Young's Modulus, $E_{T_{90}}$ , (psi):	8940
Strain Rate, (%/min):	0.34
Total Density, (pcf):	110.2
Specimen Diameter, d (in.):	6.00
Specimen Height, h (in.):	12.00
Height/Diameter Ratio:	2.00
Specific Gravity, Gs:	(Assumed) 2.75

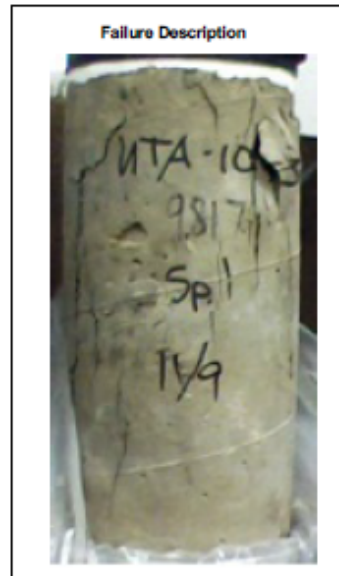

**INTEGRATED PIPELINE PROJECT**

**UNCONFINED COMPRESSION TEST RESULT**

**Tarrant Regional Water District**

ASTM D 4832

Tested By:  
Teodor Petkov

Date Tested:  
11/9/2012

Checked By:  
Jaime Reyes

Project No.  
04.4011-1012

**PLATE F - 17**



FUGRO UNCONFINED CLSM FUGRO DATA TEMPLATE 10/6/10.GDT FUGRO LIBRARY 03/21/12 11:00:01.GLB 1:PROJECT FILES\PROJECTS\041111-1012 PI PHASE 2\MI\SD044011-1012.GPJ revised 12/1/12

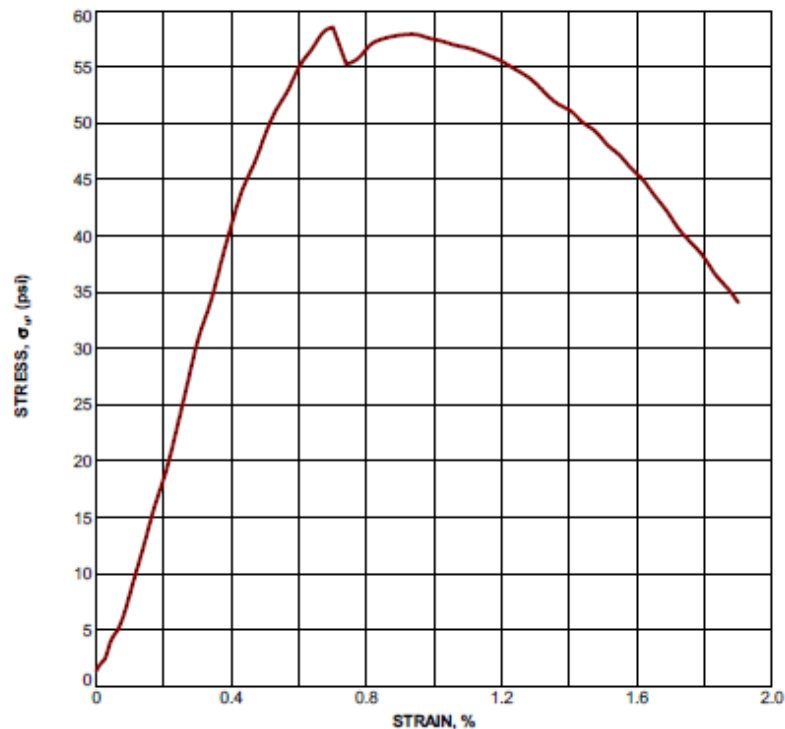

Sample No.:	UTA2-10
Remarks:	Native
Sample Type:	Flowable Fill
Admixture:	10% Cement
Cure Time, (days):	3
Unconfined Compression Strength, $\sigma_u$ (psi):	58.50
Undrained Shear Strength, $S_u$ (psi):	29.25
Strain at Failure, (%):	0.70
Young's Modulus, $E_{50}$ (psi):	11503
Strain Rate, (%/min):	0.34
Total Density, (pcf):	106.6
Specimen Diameter, d (in.):	6.00
Specimen Height, h (in.):	12.00
Height/Diameter Ratio:	2.00
Specific Gravity, Gs:	(Assumed) 2.75

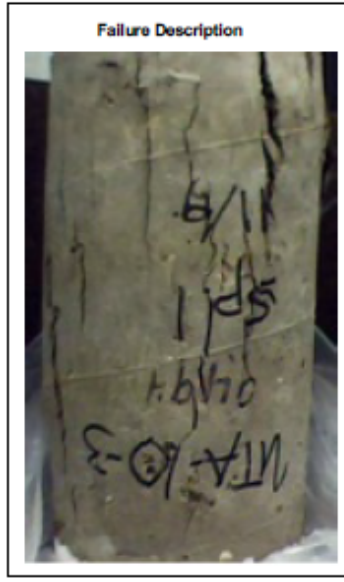

 Fugro Consultants, Inc	<b>INTEGRATED PIPELINE PROJECT</b>		<b>UNCONFINED COMPRESSION TEST RESULT</b>		
	<b>Tarrant Regional Water District</b>			<b>ASTM D 4832</b>	
	Tested By: Teodor Petkov	Date Tested: 11/9/2012	Checked By: Jalme Reyes	Project No. 04.4011-1012	<b>PLATE F - 18</b>

FUGRO UNCONFINED CLSM FUGRO DATA TEMPLATE 1001610.GDT FUGRO LIBRARY 05212 (LCKT).GLB \\PROJECT FILES\PROJECTS-2011\11-10-12\PL PHASE 2M\SC044011-1012.GPJ rnyw 12/3/12

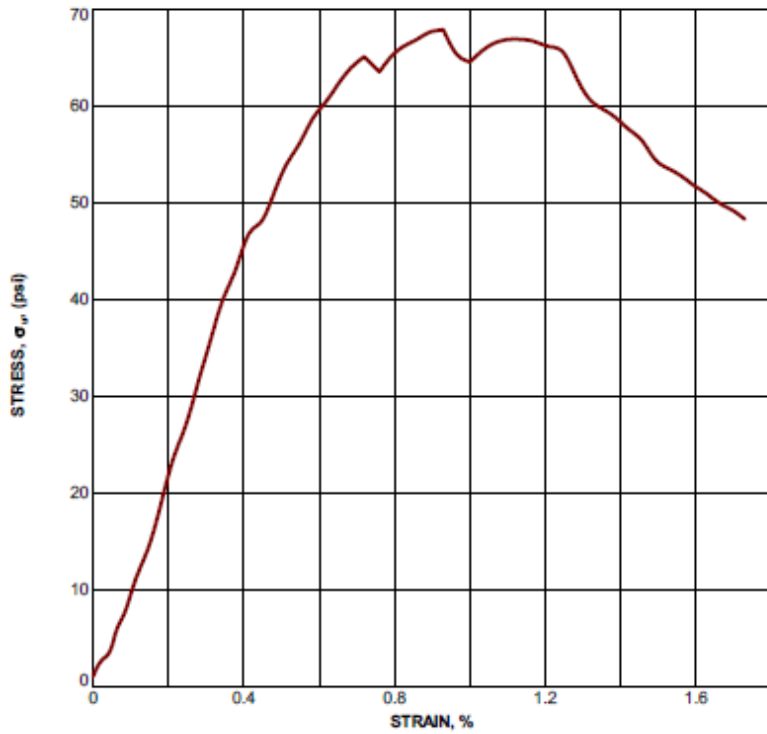

Sample No.:	UTA2-10
Remarks:	Native
Sample Type:	Flowable Fill
Admixture:	10% Cement
Cure Time, (days):	5
Unconfined Compression Strength, $\sigma_u$ , (psi):	67.80
Undrained Shear Strength, $S_u$ , (psi):	33.90
Strain at Failure, (%):	0.93
Young's Modulus, $E_{750}$ , (psi):	12514
Strain Rate, (%/min):	0.34
Total Density, (pcf):	107.8
Specimen Diameter, d (in.):	6.00
Specimen Height, h (in.):	12.00
Height/Diameter Ratio:	2.00
Specific Gravity, Gs:	(Assumed) 2.75

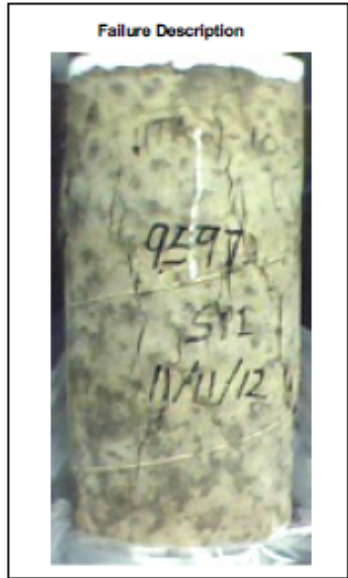

<b>INTEGRATED PIPELINE PROJECT</b>		<b>UNCONFINED COMPRESSION TEST RESULT</b>		
<b>Tarrant Regional Water District</b>				ASTM D 4832
Tested By: Teodor Petkov	Date Tested: 11/11/2012	Checked By: Jalme Reyes	Project No. 04.4011-1012	<b>PLATE F - 19</b>

FUGRO UNCONFINED CLSM FUGRO DATA TEMPLATE 100816.GDT FUGRO LIBRARY 082212 (L)OKT.GLS \PROJECT FILES\PROJECTS-2011\11-10\12-PL PHASE 2\MI-92044401-1-10\12-GRJ\_revised\_120112

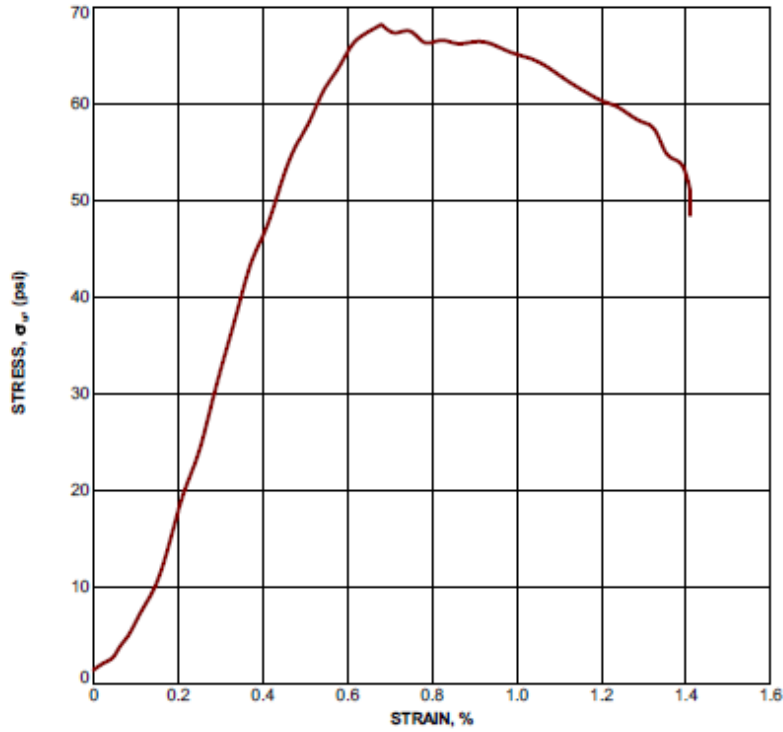

Sample No.:	UTA2-10
Remarks:	Native
Sample Type:	Flowable Fill
Admixture:	10% Cement
Cure Time, (days):	5
Unconfined Compression Strength, $\sigma_u$ , (psi):	68.14
Undrained Shear Strength, $S_u$ , (psi):	34.07
Strain at Failure, (%):	0.68
Young's Modulus, $E_{750}$ , (psi):	14828
Strain Rate, (%/min):	0.31
Total Density, (pcf):	108.1
Specimen Diameter, d (in.):	6.00
Specimen Height, h (in.):	12.00
Height/Diameter Ratio:	2.00
Specific Gravity, Gs:	(Assumed) 2.75



**INTEGRATED PIPELINE PROJECT**

**UNCONFINED COMPRESSION TEST RESULT**

**Tarrant Regional Water District**

**ASTM D 4832**

Tested By:  
Teodor Petkov

Date Tested:  
11/11/2012

Checked By:  
Jaime Reyes

Project No.  
04.4011-1012

**PLATE F - 20**

FUGRO UNCONFINED CLSM FUGRO DATA TEMPLATE 100610.GDT FUGRO LIBRARY 082712.LOKT.GLB 1 PROJECT FILES\PROJECTS\2011\1-1012 PL PHASE 2\MI\SCM44011-1012.GPJ rev04 12/1/12

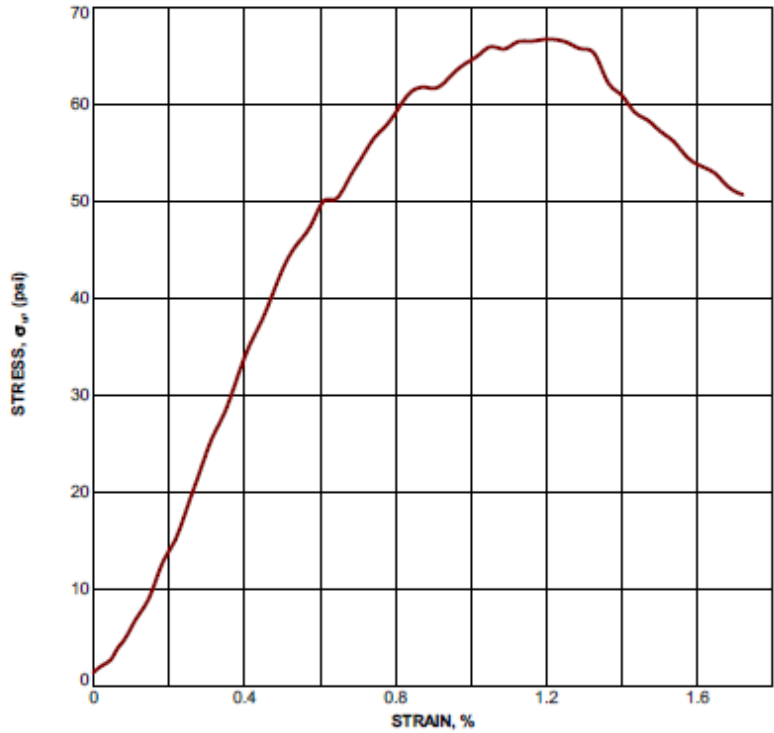

Sample No.:	UTA2-10
Remarks:	Native
Sample Type:	Flowable Fill
Admixture:	10% Cement
Cure Time, (days):	5
Unconfined Compression Strength, $\sigma_u$ , (psi):	66.60
Undrained Shear Strength, $S_u$ , (psi):	33.30
Strain at Failure, (%):	1.19
Young's Modulus, $E_{50}$ , (psi):	9767
Strain Rate, (%/min):	0.34
Total Density, (pcf):	110.6
Specimen Diameter, d (in.):	6.00
Specimen Height, h (in.):	12.00
Height/Diameter Ratio:	2.00
Specific Gravity, Gs:	(Assumed) 2.75

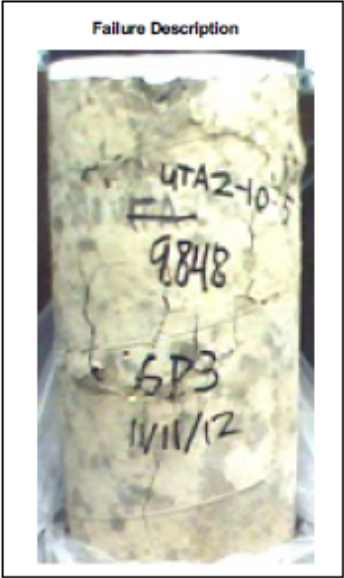

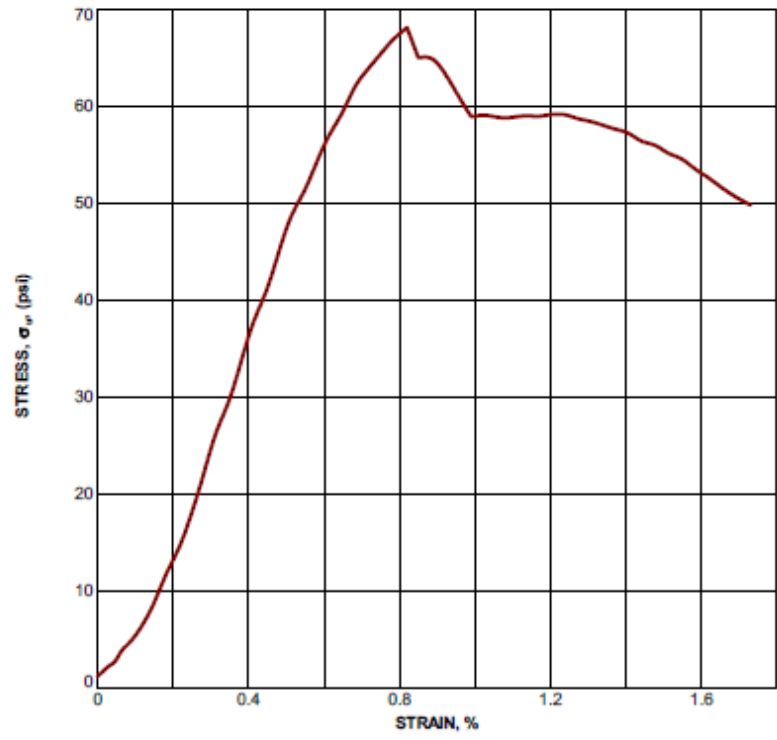

 Fugro Consultants, Inc.	<b>INTEGRATED PIPELINE PROJECT</b>		<b>UNCONFINED COMPRESSION TEST RESULT</b>		
	<b>Tarrant Regional Water District</b>			ASTM D 4832	
	Tested By: Teodor Petkov	Date Tested: 11/11/2012	Checked By: Jalme Reyes	Project No. 04.4011-1012	<b>PLATE F - 21</b>

FUGRO UNCONFINED CLSM FUGRO DATA TEMPLATE 10/06/10.GDT FUGRO LIBRARY 05/22/12 L0073.GLB \\PROJECT FILES\PROJECTS\2011\11-1012\_PIL PHASE 2\MI 50044\01-1-1012.GPJ nroyal 1/23/12

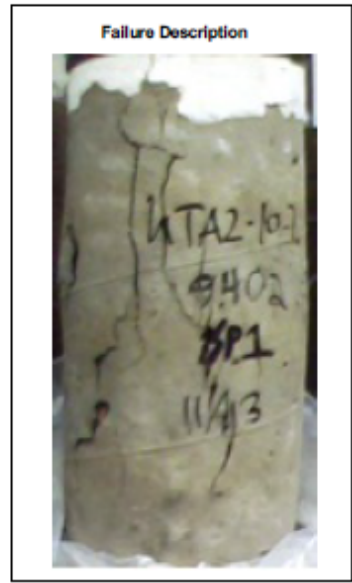

Sample No.:	UTA2-10
Remarks:	Native
Sample Type:	Flowable Fill
Admixture:	10% Cement
Cure Time, (days):	7
Unconfined Compression Strength, $\sigma_u$ , (psi):	68.03
Undrained Shear Strength, $S_u$ , (psi):	34.01
Strain at Failure, (%):	0.82
Young's Modulus, $E_{TENS}$ , (psi):	11857
Strain Rate, (%/min):	0.34
Total Density, (pcf):	105.6
Specimen Diameter, d (in.):	6.00
Specimen Height, h (in.):	12.00
Height/Diameter Ratio:	2.00
Specific Gravity, Gs:	(Assumed) 2.75



 Fugro Consultants, Inc	<b>INTEGRATED PIPELINE PROJECT</b>		<b>UNCONFINED COMPRESSION TEST RESULT</b>		
	<b>Tarrant Regional Water District</b>			<b>ASTM D 4832</b>	
	Tested By: Teodor Petkov	Date Tested: 11/13/2012	Checked By: Jaime Reyes	Project No. 04.4011-1012	PLATE F - 22

FUGRO UNCONFINED CLSM FUGRO DATA TEMPLATE 10/16/10.GDT FUGRO LIBRARY 02/21/12 LOKYI.GLB 1:PROJECT FILES\PROJECTS\041111-1012 PL PHASE 2\MI\SD\44011-1012.GRU rev 04 - 12/1/12

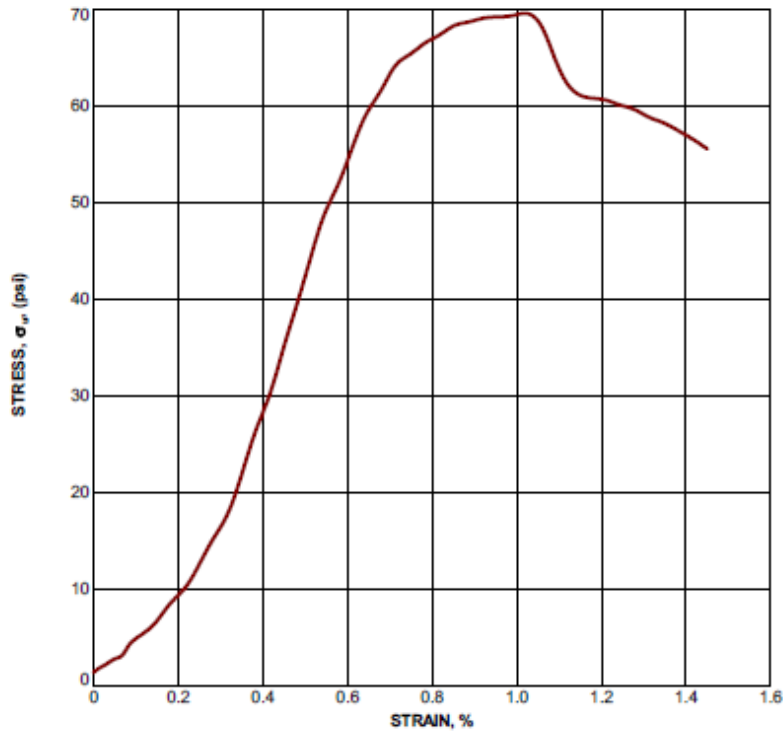

Sample No.:	UTA2-10
Remarks:	Native
Sample Type:	Flowable Fill
Admixture:	10% Cement
Cure Time, (days):	7
Unconfined Compression Strength, $\sigma_u$ , (psi):	69.42
Undrained Shear Strength, $S_u$ , (psi):	34.71
Strain at Failure, (%):	1.03
Young's Modulus, $E_{280}$ , (psi):	13576
Strain Rate, (%/min):	0.34
Total Density, (pcf):	107.2
Specimen Diameter, d (in.):	6.00
Specimen Height, h (in.):	12.00
Height/Diameter Ratio:	2.00
Specific Gravity, Gs:	(Assumed) 2.75

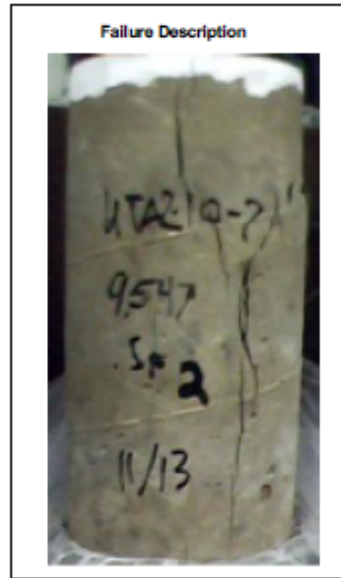

<b>INTEGRATED PIPELINE PROJECT</b>		<b>UNCONFINED COMPRESSION TEST RESULT</b>	
<b>Tarrant Regional Water District</b>		ASTM D 4832	
Tested By: Teodor Petkov	Date Tested: 11/13/2012	Checked By: Jalme Reyes	Project No. 04.4011-1012
			<b>PLATE F - 23</b>

FUGRO UNCONFINED CLSM FUGRO DATA TEMPLATE 10/6/10.GDT FUGRO LIBRARY 05/21/12.LOCYD.GLB L:\PROJECT FILES\PROJECTS-2011\11-10-12 PL PHASE 2\MS0044011-1012.GPJ myval 12/1/12

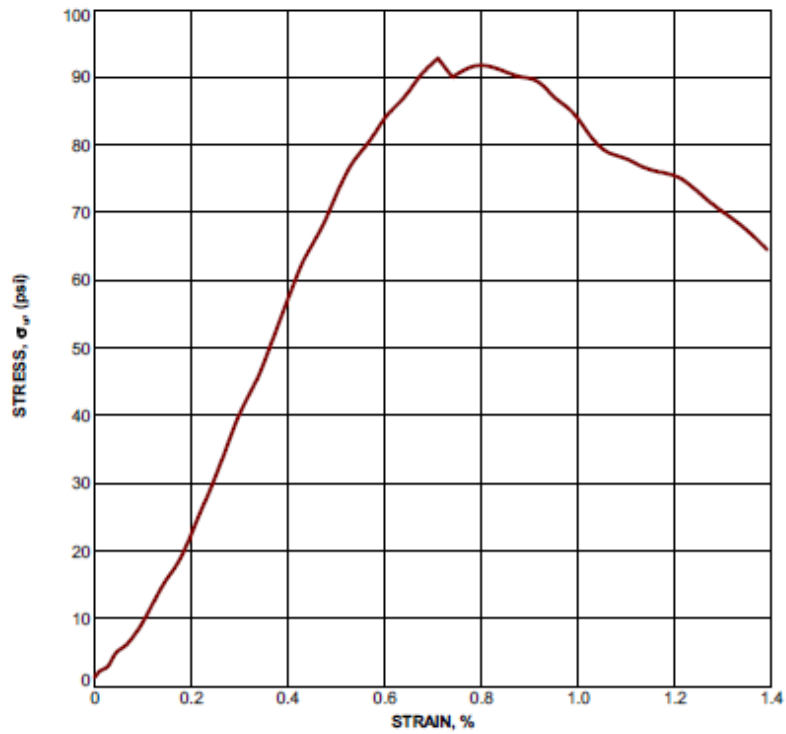

Sample No.:	UTA2-10
Remarks:	Native
Sample Type:	Flowable Fill
Admixture:	10% Cement
Cure Time, (days):	7
Unconfined Compression Strength, $\sigma_v$ , (psi):	92.80
Undrained Shear Strength, $S_u$ , (psi):	46.40
Strain at Failure, (%):	0.71
Young's Modulus, $E_{TCR}$ , (psi):	17427
Strain Rate, (%/min):	0.34
Total Density, (pcf):	107.4
Specimen Diameter, d (in.):	6.00
Specimen Height, h (in.):	12.00
Height/Diameter Ratio:	2.00
Specific Gravity, Gs:	(Assumed) 2.75

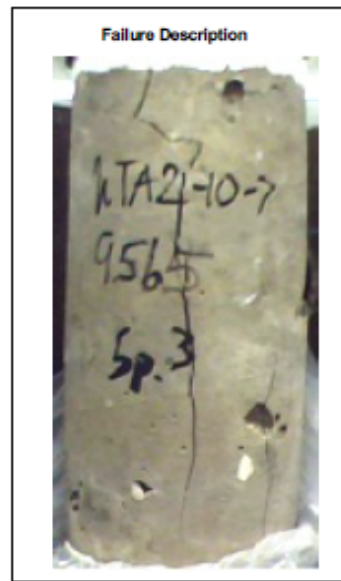

Fugro Consultants, Inc

**INTEGRATED PIPELINE PROJECT**

**UNCONFINED COMPRESSION TEST RESULT**

**Tarrant Regional Water District**

ASTM D 4832

Tested By:  
Teodor Petkov

Date Tested:  
11/13/2012

Checked By:  
Jaime Reyes

Project No.  
04.4011-1012

**PLATE F - 24**

FUGRO UNCONFINED CLUM FUGRO DATA TEMPLATE 100610.GDT FUGRO LIBRARY 022913.LOCT01.GLB 1 PROJECT FILES PROJECTS\01\11-10\02 PHASE 2\MS\04\4011-10\02.GPJ myval 12/4/12

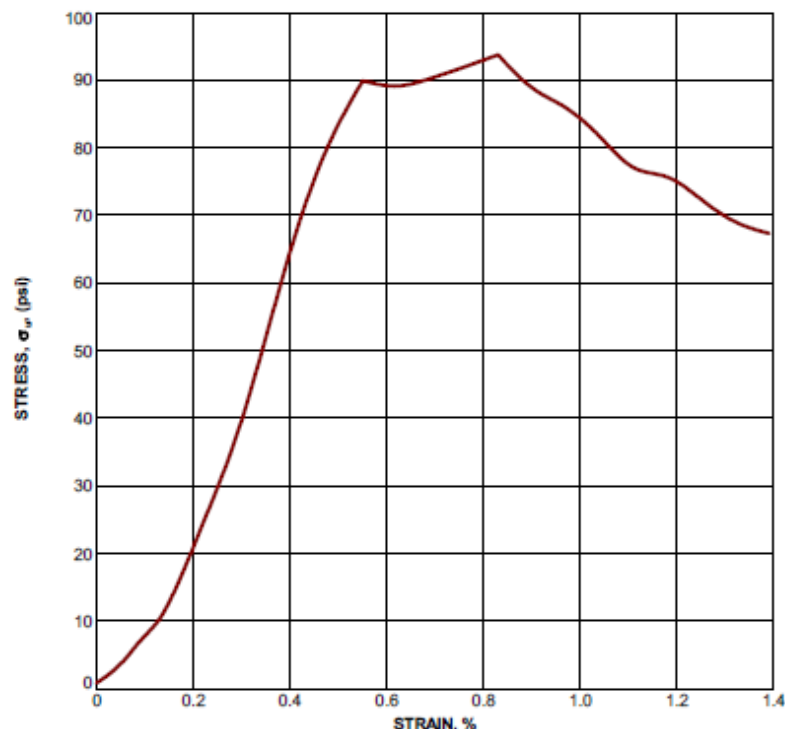

Sample No.:	UTA2-10
Remarks:	Native
Sample Type:	Flowable Fill
Admixture:	10% Cement
Cure Time, (days):	28
Unconfined Compression Strength, $\sigma_u$ , (psi):	93.74
Undrained Shear Strength, $S_u$ , (psi):	46.87
Strain at Failure, (%):	0.83
Young's Modulus, $E_{290}$ , (psi):	19604
Strain Rate, (%/min):	0.68
Total Density, (pcf):	107.5
Specimen Diameter, d (in.):	6.00
Specimen Height, h (in.):	12.00
Height/Diameter Ratio:	2.00
Specific Gravity, Gs:	(Assumed) 2.75

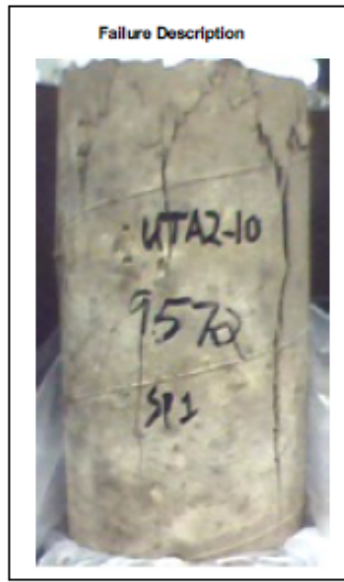

 Fugro Consultants, Inc.	<b>INTEGRATED PIPELINE PROJECT</b>		<b>UNCONFINED COMPRESSION TEST RESULT</b>		
	<b>Tarrant Regional Water District</b>			ASTM D 4832	
	Tested By: Teodor Petkov	Date Tested: 12/4/2012	Checked By: Jaime Reyes	Project No. 04.4011-1012	<b>PLATE F - 25</b>



FUGRO UNCONFINED CLSM FUGRO DATA TEMPLATE 100610.GDT FUGRO LIBRARY 02/21/12 0.0001 GLOB \PROJECT FILES\PROJECTS\2011\11-10-12\_PL.PHASE 2\MISC\04-011-1012.GPJ rev04 12/4/12

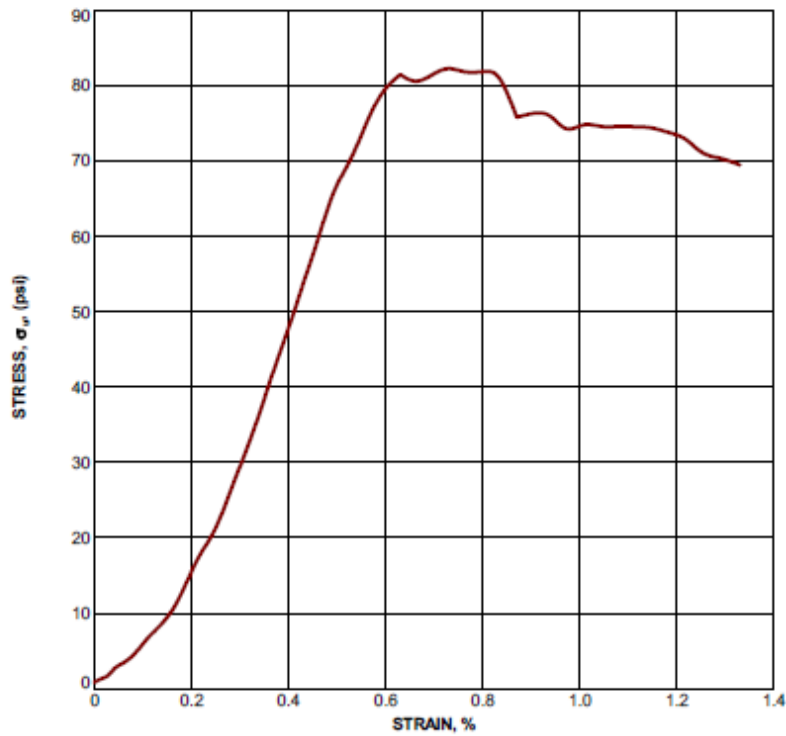

Sample No.:	UTA2-10
Remarks:	Native
Sample Type:	Flowable Fill
Admixture:	10% Cement
Cure Time, (days):	28
Unconfined Compression Strength, $\sigma_v$ (psi):	82.19
Undrained Shear Strength, $S_u$ (psi):	41.10
Strain at Failure, (%):	0.73
Young's Modulus, $E_{100}$ (psi):	17453
Strain Rate, (%/min):	0.34
Total Density, (pcf):	107.6
Specimen Diameter, d (in.):	6.00
Specimen Height, h (in.):	12.00
Height/Diameter Ratio:	2.00
Specific Gravity, Gs:	(Assumed) 2.75



<b>INTEGRATED PIPELINE PROJECT</b>		<b>UNCONFINED COMPRESSION TEST RESULT</b>	
<b>Tarrant Regional Water District</b>		<b>ASTM D 4832</b>	
Tested By: Teodor Petkov	Date Tested: 12/4/2012	Checked By: Jalme Reyes	Project No. 04.4011-1012
			<b>PLATE F - 26</b>

FUGRO UNCONFINED CUSM FUGRO DATA TEMPLATE 100610.GDT FUGRO LIBRARY 02212 (LCKT).GDB I:\PROJECT FILES\PROJECTS\2011\11-10-12 P.L.PHASE 2\MS0044011-1012.GPJ roy.wj 12/4/12

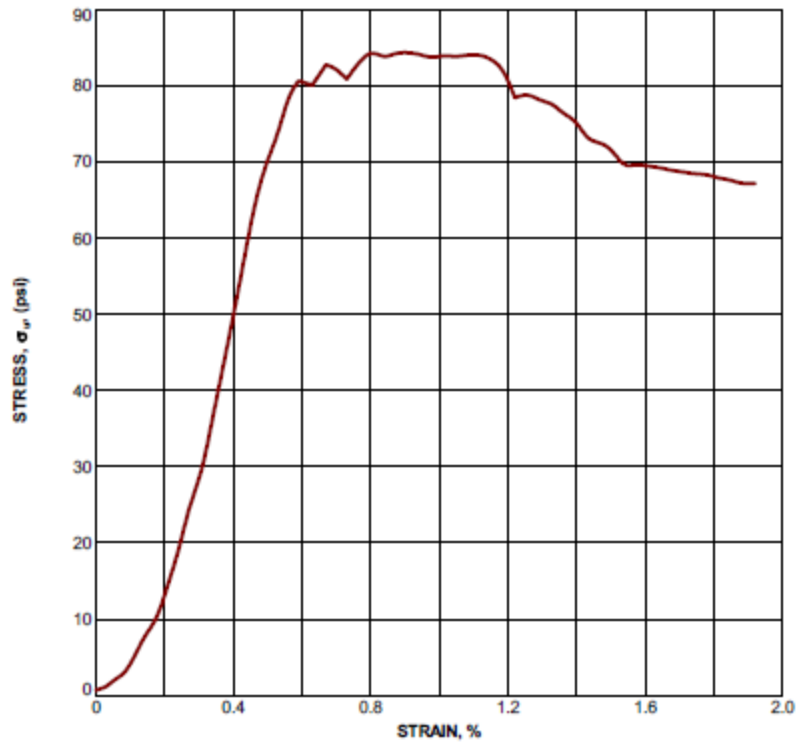

Sample No.:	UTA2-10
Remarks:	Native
Sample Type:	Flowable Fill
Admixture:	10% Cement
Cure Time, (days):	28
Unconfined Compression Strength, $\sigma_u$ , (psi):	84.27
Undrained Shear Strength, $S_u$ , (psi):	42.13
Strain at Failure, (%):	0.91
Young's Modulus, $E_{TSP}$ , (psi):	19518
Strain Rate, (%/min):	0.34
Total Density, (pcf):	109.6
Specimen Diameter, d (in.):	6.00
Specimen Height, h (in.):	12.00
Height/Diameter Ratio:	2.00
Specific Gravity, Gs:	(Assumed) 2.75

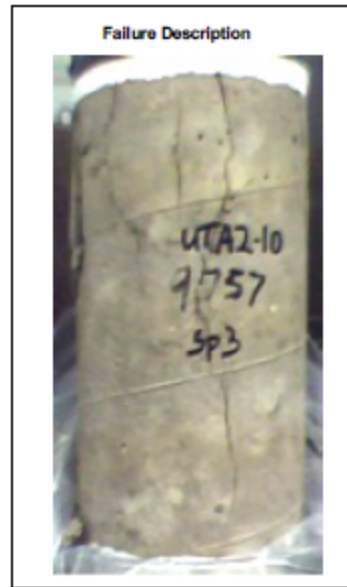

<b>INTEGRATED PIPELINE PROJECT</b>		<b>UNCONFINED COMPRESSION TEST RESULT</b>		
Tarrant Regional Water District		ASTM D 4832		
Tested By: Teodor Petkov	Date Tested: 12/4/2012	Checked By: Jaime Reyes	Project No. 04.4011-1012	PLATE F - 27

Appendix B  
Density Control and Proctor Degree of Compaction  
By Fugro Consultants, Inc.

**LABORATORY MOISTURE-DENSITY TEST REPORT**  
**MOISTURE DENSITY RELATIONSHIP**



FUGRO CONSULTANTS, INC.

2880 Virgo Lane Dallas, Texas 75229 Tel 972 484-8301 Fax 972 620-7328

Job No.: 4011-1012 Project: Integrated Pipeline Project  
 Test Date: 11/9/2012 Location: RHBPS  
 Client: Tarrant Regional Water District

Soil Description: Lean Clay with Sand Test Method: ASTM D-698A  
 Sample Source: Native Rammer Type: Mechanical  
 Sample Identification: 8177 Prep. Method: Wet  
 Received Date: 11/6/2012

**Test Results:** **Atterberg Limits:** ASTM D-4318 Method A  
 Maximum Dry Density 106.5 lbs/cu-ft Liquid Limit 39  
 Optimum Moisture Content 17.6 % Plastic Limit 17  
 Plasticity Index 22  
**Corrected Test Results:**  
 Maximum Dry Density 106.5 lbs/cu-ft Percent Passing No. 200 Sieve: 75  
 Optimum Moisture Content 17.6 % Specific Gravity: 2.65 (Estimated)

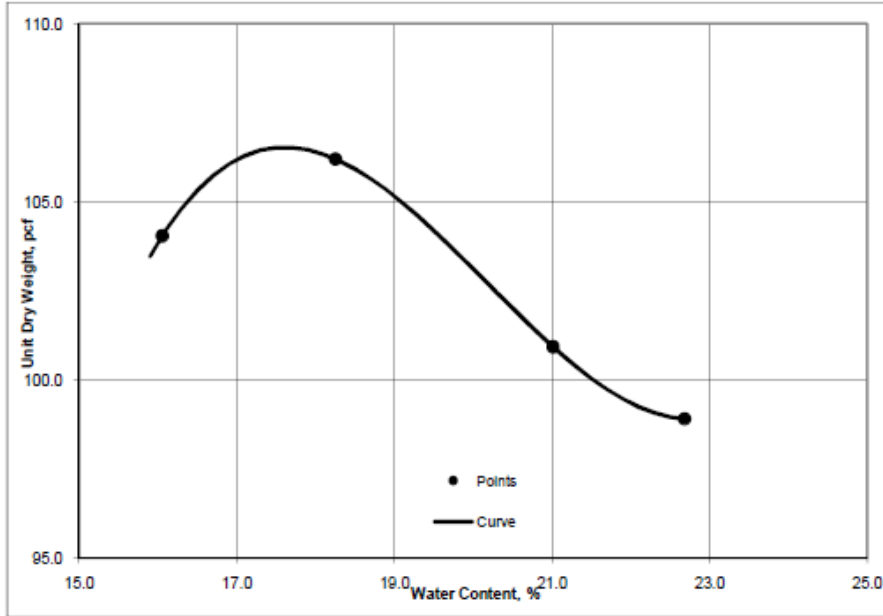

Plate F-3

FUGRO CONSULTANTS, INC.  
 2880 Virgo Lane, Dallas, Texas 75229  
 Phone: 972 484-8301 Fax 972 620-7328



**IN-PLACE MOISTURE DENSITY TEST RESULTS**

Client: Tarrant Regional Water District  
 Project: Integrated Pipeline Project  
 Tech: Steven Coy

Report Date: 12/3/2012  
 Project No: 4011-1012  
 Date Performed: 11/8/2012

Test No.	Test Location	Depth <input type="checkbox"/> Lift <input checked="" type="checkbox"/>	Wet Density (pcf)	Field Moisture (%)	Dry Density (pcf)	Proctor No.	Percent Proctor Density
<b>Large Diameter Steel Pipe</b>							
1	CAN #1, 8' E of E Control Box, north side	1st	94.0	12.0	83.9	8183	85.4*
2	CAN #1,16' E of E Control Box, north side	1st	96.3	9.5	87.9	8183	89.4*
3	CAN #1,16' E of E Control Box, south side	1st	94.1	9.9	85.6	8183	87.1*
4	CAN #1, 8' E of E Control Box, south side	1st	97.8	12.3	87.1	8183	88.6*
5	CAN #3,16' W of W Control Box, north side	1st	116.6	24.0	94.0	8177	88.3*
6	CAN #3, 8' W of W Control Box, northside	1st	122.6	21.4	101.0	8177	94.8*
7	CAN #3, 8' W of W Control Box, south side	1st	124.1	21.9	101.8	8177	95.6
8	Can #3,16' W of W Control Box, south side	1st	121.8	23.9	98.3	8177	92.3*
9	Retest from #5	1st	121.9	17.8	103.5	8177	97.2
10	Retest From #8	1st	121.4	20.0	101.2	8177	95.0
11	CAN #1, 8' E of E Control Box	2nd	104.0	12.8	92.2	8177	86.6*
12	CAN #1,16' E of E Control Box, north side	2nd	103.7	12.7	92.0	8177	86.4*
13	CAN#1, 8' E of E Control Box, south side	2nd	107.3	9.7	97.8	8177	91.8*
14	CAN #1,16' E of E Control Box, south side	2nd	102.3	8.9	93.9	8177	88.2*
15	CAN #3,16' W of W Control Box, north side	2nd	122.0	13.2	107.8	8177	101.2
16	CAN #3, 8' W of W Control Box, north side	2nd	120.5	16.0	103.9	8177	97.6
17	CAN #3,16' W of W Control Box, south side	2nd	129.0	13.5	113.7	8177	106.8
18	CAN #3, 8' W of W Control Box, south side	2nd	124.3	12.5	110.5	8177	103.8
19	CAN #2, 8' W of W Control Box, north side	1st	120.5	13.5	106.2	8177	99.7
20	CAN #2,16' W of W Control Box, north side	1st	118.2	16.9	101.1	8177	94.9*
21	CAN #2, 8' W of W Control Box, south side	1st	125.9	13.0	111.4	8177	104.6
22	CAN #2,16' W of W Control Box, south side	1st	119.2	14.0	104.6	8177	98.2

Proctor No:	Description	Opt. Moisture	Max. Density
8177	Lean Clay with Sand	17.6	106.5
8183	Poorly Graded Sand with Silt	6.4	98.3

Specs.	Gauge No:	1283	Test Methods:	ASTM D 6938
Dens. (%)	Min 95	Std. Density Count:	2626	ASTM D 698
Moist. (%)	N/A	Std. Moist Count:	508	
	Trans. Depth (in.):	6		

Remarks: \* - indicates that the Dry Density does not comply with the specifications.

PLATE F-5

FUGRO CONSULTANTS, INC.  
 2880 Virgo Lane, Dallas, Texas 75229  
 Phone: 972 484-8301 Fax 972 620-7328



**IN-PLACE MOISTURE DENSITY TEST RESULTS**

Client: Tarrant Regional Water District  
 Project: Integrated Pipeline Project  
 Tech: Steven Coy

Report Date: 12/3/2013  
 Project No: 4011-1012  
 Date Performed: 11/8/2012

Test No.	Test Location	Depth <input type="checkbox"/> Lift <input checked="" type="checkbox"/>	Wet Density (pcf)	Field Moisture (%)	Dry Density (pcf)	Proctor No.	Percent Proctor Density
23	CAN #2, 8' W of E Control Box	2nd	121.5	12.3	108.2	8177	101.6
24	CAN #2, 16' W of E Control Box, s. side	2nd	120.6	12.3	107.4	8177	100.8
25	CAN, #2, 8' W of E Control Box, s. side	2nd	124.3	13.7	109.3	8177	102.6
26	CAN #2, 16' W of E Control Box, s. side	2nd	122.4	16.0	105.5	8177	99.1

Proctor No:	Description	Opt. Moisture	Max. Density
8177	Lean Clay with Sand	17.6	106.5

Specs.	Gauge No:	1283	Test Methods:	ASTM D 6938
Dens. (%)	Min 95	Std. Density Count:	2626	ASTM D 698
Moist. (%)	N/A	Std. Moist Count:	508	
	Trans. Depth (in.):	6		

PLATE F-6

FUGRO CONSULTANTS, INC.  
 2880 Virgo Lane, Dallas, Texas 75229  
 Phone: 972 484-8301 Fax 972 620-7328



**IN-PLACE MOISTURE DENSITY TEST RESULTS**

Client: Tarrant Regional Water District  
 Project: Integrated Pipeline Project  
 Tech: Steven Coy

Report Date: 12/3/2012  
 Project No: 4011-1012  
 Date Performed: 11/9/2012

Test No.	Test Location	Depth <input type="checkbox"/> Lift <input checked="" type="checkbox"/>	Wet Density (pcf)	Field Moisture (%)	Dry Density (pcf)	Proctor No.	Percent Proctor Density
	<b>CAN #2</b>						
27	16' W of E Control Box, south side	4th	132.0	14.9	114.9	8177	107.9
28	8' W of E Control Box, south side	4th	120.0	14.4	104.9	8177	98.5
29	CAN #3, 16' W of W Control Box, n. side	4th	123.8	16.2	106.5	8177	100.0
30	CAN #3, 8' W of W Control Box, n. side	4th	125.5	14.9	109.2	8177	102.5
31	CAN #3, 8' W of W Control Box, mid-ctr.	3rd	116.2	15.7	100.4	8177	94.3
32	CAN #3, 16' W of W Control Box, mid.ctr	3rd	118.6	20.0	98.8	8177	92.8
33	CAN #3, 16' W of W Control Box, s. side	4th	117.8	13.8	103.5	8177	97.2
34	CAN #3, 8' W of W Control Box, s. side	4th	122.5	15.1	106.4	8177	99.9
35	CAN #2, 8' E of W Box, n. side	5th	123.6	13.9	108.5	8177	101.9
36	CAN #2, 16' E of W Box, n. side	5th	119.4	16.7	102.3	8177	96.1
37	CAN #2, 8' E of W Control Box, mid-ctr	2nd	122.3	12.0	109.2	8177	102.5
38	CAN #2, 16' E of W Control Box, mid-ctr	2nd	125.1	12.8	110.9	8177	104.1
39	CAN #2, 8' E of W Control Box, s. side	5th	121.3	11.3	109.0	8177	102.3
40	CAN #2, 16' E of W Control Box, s. side	5th	118.3	13.0	104.7	8177	98.3
41	CAN #1, 8' E of E Control Box, n. side	3rd	121.6	15.5	105.3	8177	98.9
42	CAN #1, 16' E of E Control Box, n. side	3rd	112.9	12.6	100.3	8177	94.2
43	CAN #1, 8' E of E Control Box, mid-ctr	1st	119.2	15.1	103.6	8177	97.3
44	CAN #1, 16' E of E Control Box, mid-ctr	1st	126.1	14.0	110.6	8177	103.8
45	CAN #1, 8' E of E Control Box, s. side	3rd	127.1	15.3	110.2	8177	103.5
46	CAN #1, 16' E of E Control Box, s. side	3rd	124.8	14.9	108.6	8177	102.0
47	CAN #1, 8' E of E Control Box, n. side	4th	123.8	13.3	109.3	8177	102.6
48	CAN #1, 16' E of E Control Box, n. side	4th	130.5	14.6	113.9	8177	106.9

Proctor No:	Description	Opt. Moisture	Max. Density
8177	Lean Clay with Sand	17.6	106.5

Specs.		Gauge No:	1283	Test Methods:	ASTM D 6938
Dens. (%)	Min 90	Std. Density Count:	2626		ASTM D 698
Moist. (%)	N/A	Std. Moist Count:	508		
		Trans. Depth (in.):	6		

PLATE F-7

FUGRO CONSULTANTS, INC.  
 2880 Virgo Lane, Dallas, Texas 75229  
 Phone: 972 484-8301 Fax 972 620-7328



**IN-PLACE MOISTURE DENSITY TEST RESULTS**

Client: Tarrant Regional Water District  
 Project: Integrated Pipeline Project  
 Tech: Steven Coy

Report Date: 12/3/2012  
 Project No: 4011-1012  
 Date Performed: 11/9/2012

Test No.	Test Location	Depth <input type="checkbox"/> Lift <input checked="" type="checkbox"/>	Wet Density (pcf)	Field Moisture (%)	Dry Density (pcf)	Proctor No.	Percent Proctor Density
49	8' E of E Control Box, mid-ctr	2nd	126.8	15.9	109.4	8177	102.7
50	16' E of E Control Box, mid-ctr	2nd	132.9	12.7	117.9	8177	110.7
51	8' E of E Control Box, s. side	4th	128.5	12.6	114.1	8177	107.1
52	16' E of E Control Box, s. side	4th	130.1	14.7	113.4	8177	106.5
Proctor No:		Description			Opt. Moisture	Max. Density	
8177		Lean Clay with Sand			17.6	106.5	
Specs.		Gauge No:	1283		Test Methods:		ASTM D 6938
Dens. (%)	Min 90	Std. Density Count:	2626				ASTM D 698
Moist. (%)	N/A	Std. Moist Count:	508				
		Trans. Depth (in.):	6				

PLATE F-8



FUGRO CONSULTANTS, INC.  
 2880 Virgo Lane, Dallas, Texas 75229  
 Phone: 972 484-8301 Fax 972 620-7328



**IN-PLACE MOISTURE DENSITY TEST RESULTS**

Client: Tarrant Regional Water District  
 Project: Integrated Pipeline Project  
 Tech: Steven Coy

Report Date: 12/3/2012  
 Project No: 4011-1012  
 Date Performed: 11/9/2012

Test No.	Test Location	Depth <input type="checkbox"/> Lift <input checked="" type="checkbox"/>	Wet Density (pcf)	Field Moisture (%)	Dry Density (pcf)	Proctor No.	Percent Proctor Density
53	CAN #3, 8' W of W Control Box, s. side	3rd	126.3	16.2	108.7	8177	102.1
54	CAN #3, 16' W of W Control Box, s. side	3rd	127.5	15.3	110.6	8177	103.8
55	CAN #3, 8' W of box, mid-ctr.	2nd	118.8	17.2	101.4	8177	95.2
56	CAN #3, 16' W of box, mid-ctr.	2nd	123.6	15.3	107.2	8177	100.7
57	CAN #3, 8' W of box, n. side	3rd	124.0	14.7	108.1	8177	101.5
58	CAN #3, 16' W of box, n. side	3rd	118.6	15.8	102.4	8177	96.2
59	CAN #2, 16' W of E Control Box, s. side	3rd	121.5	11.4	109.1	8177	102.4
60	CAN #2, 8' W of E Control Box, s. side	3rd	124.3	14.9	108.2	8177	101.6
61	CAN #2, 8' W of E Control Box, n. side	3rd	123.3	12.8	109.3	8177	102.6
62	CAN #2, 16' W of E Control Box, n. side	3rd	123.3	11.8	110.3	8177	103.6
63	CAN #1, 8' E of E Control Box, n. side	1st/N	118.2	11.3	106.2	8177	99.7
64	CAN #1, 16' E of E Control Box, s. side	1st/N	120.4	15.3	104.4	8177	98.0
65	CAN #1, 8' E of E Control Box, s. side	1st/N	116.9	14.5	102.1	8177	95.9
66	CAN #1, 16' E of E Control Box, s. side	1st/N	120.6	15.2	104.7	8177	98.3
67	CAN #1, 16' E (natural), n. side	2nd	125.7	15.2	109.1	8177	102.4
68	CAN #1, 8' E (natural), n. side	2nd	117.9	17.8	100.1	8177	94.0
69	CAN #1, 16' E (natural), s. side	2nd	123.6	15.3	107.2	8177	100.7
70	CAN #1, 8' E (natural), s. side	2nd	119.7	14.7	104.4	8177	98.0
71	CAN #2, 16' W of E Control Box, n. side	4th	131.7	15.8	113.7	8177	106.8
72	CAN #2, 8' W of E Control Box, n. side	4th	129.1	11.8	115.5	8177	108.5
73	CAN #2, 8' W of E Control Box, mid-ctr	1st	122.4	13.3	108.0	8177	101.4
74	CAN #2, 16' W of E Control Box, mid-ctr.	1st	125.4	14.0	110.0	8177	103.3

Proctor No:	Description	Opt. Moisture	Max. Density
8177	Lean Clay with Sand	17.6	106.5

Specs.		Gauge No:	1283	Test Methods:	ASTM D 6938
Dens. (%)	Min 90	Std. Density Count:	2626		ASTM D 698
Moist. (%)	N/A	Std. Moist Count:	508		
		Trans. Depth (in.):	6		

PLATE F-9

Appendix C

Soil Investigation of the Field Test Location (Rolling Hills Pumping Station)

By Fugro Consultants, Inc.

**LOG OF BORING NO. B-372**  
**INTEGRATED PIPELINE PROJECT**  
 Section 9, Parcel RHBPS  
 Tarrant County, Texas  
 PROJECT NO. 04.4011-1012

**PRELIMINARY**

LATITUDE: 32.65807°  
 LONGITUDE: -97.29424°

DEPTH, FT	SYMBOL	SAMPLES	POCKET PEN BELOW REC./ROD, %	STRATUM DESCRIPTION	LAYER ELEV./ DEPTH	WATER CONTENT, %	LIQUID LIMIT, %	PLASTIC LIMIT, %	PLASTICITY INDEX (PI), %	PASSING NO. 200 SEVE, %	UNIT DRY WEIGHT, PCF	UNCONFINED ROCK STRENGTH (PSI)	
												SOIL (TSF)	ROCK (PSI)
SURF. ELEVATION: 679.0													
			P = 1.5	FILL, FAT CLAY WITH SAND (CH), very dark brown and very pale brown, moist, stiff to hard, fine grained sand, few limestone fragments, calcareous nodules	677.5								
			P = 4.5+										
			P = 4.5+										
				SANDY LEAN CLAY (CL), brown to brownish yellow, moist, stiff to hard, fine to coarse grained calcareous sand, few to some calcareous nodules, intermittent limestone fragments, calcareous, [Grayson Marl and Main Street Limestone]	1.5								
			P = 4.5+										
			P = 4.5+										
			P = 4.5+										
			P = 4.5+										
			P = 4.5+										
				LIMESTONE, very pale brown, highly weathered, soft, fractured, with interbedded shaley clay and weathered marl seams, [Grayson Marl and Main Street Limestone]	9.5								
				LEAN CLAY (CL), brownish yellow and very pale brown, moist, very stiff to hard, shaley, slickensided, calcareous, (highly weathered marl), [Grayson Marl and Main Street Limestone]	13.5								
			P = 4.5+										
				Note: Borehole backfilled with drill cuttings and capped with bentonite chips to the surface.	15.0								

IR: DRAFT LOG - FUGRO DATA TEMPLATE (10/10) .GDT - FUGRO LIBRARY\02212\LOK\GLB - L\PROJECT FILES\PROJECTS\2011\11-1012 - PL PHASE 2\MISC\04-4011-1012.GPJ REVISED 10/18/12



COMPLETION DEPTH: 15.0  
 DATE DRILLED: 10-16-12  
 WATER LEVEL / SEEPAGE: DRY  
 WATER LEVEL (UPON COMPLETION): DRY

KEY:  
 Note: All depths are measured in feet.  
 P = Pocket Penetrometer Value, (tsf)  
 N = Standard Penetration Resistance

**B-372**

Appendix D

Triaxial Test Results of the Field Test Native Soil

By Fugro Consultants, Inc.

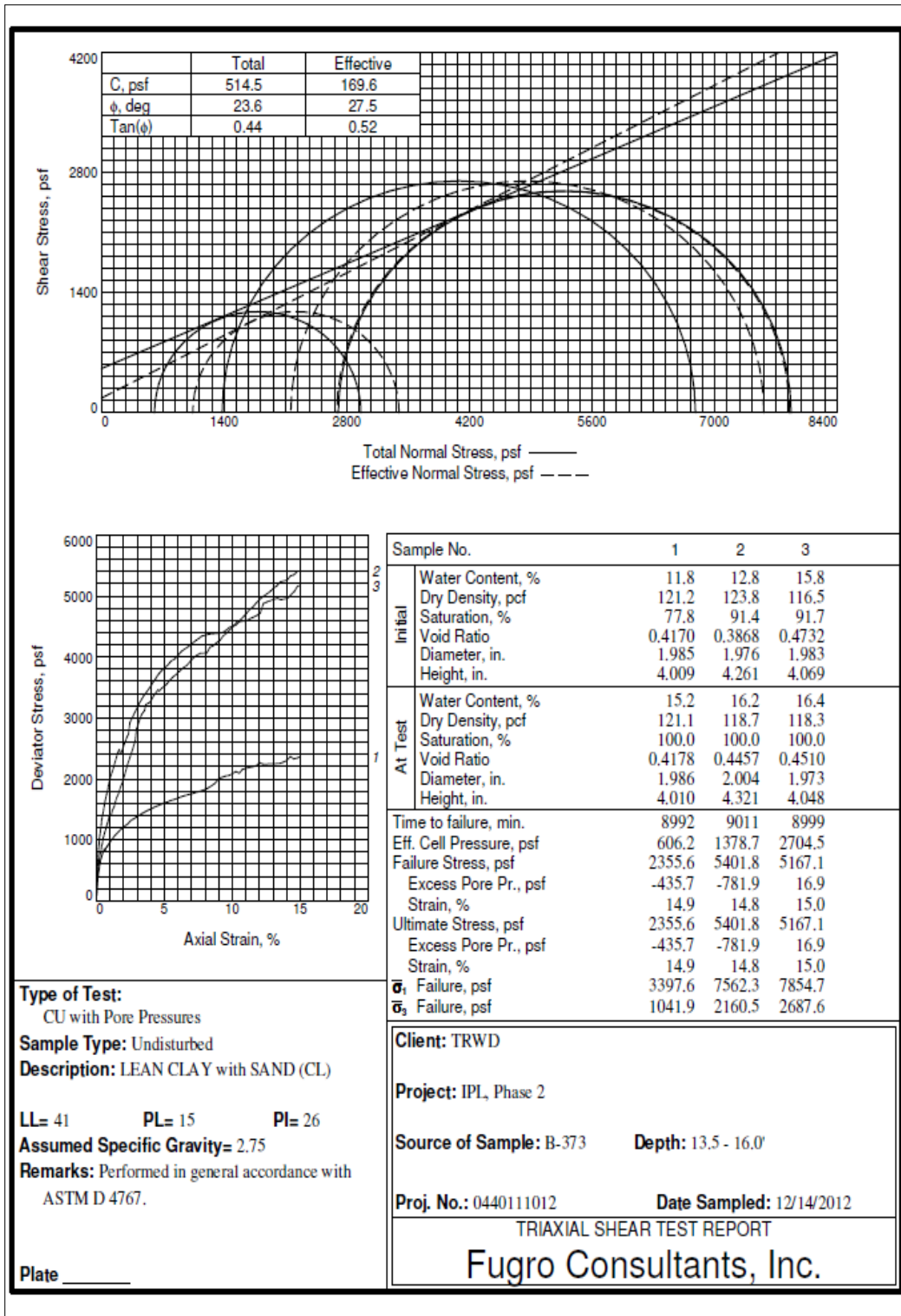

## References

1. American Water Works Association, 2004, Steel pipe: a guide for design and installation, AWWA Manual 11, 4<sup>th</sup> Edition, Denver, CO.
2. American Water Works Association, 1997, Steel Water Pipe – 6 in. and Larger, AWWA C200-97.
3. Watkins, Reynold King and Anderson, Loren Runa 2000. Structural Mechanics of Buried Pipes. CRC Press LLC.
4. Buried Flexible Steel Pipe, Design and Structural Analysis. American Society of Civil Engineers, 2009.
5. Concrete Pipe Technology Handbook. American Concrete Pipe Association, 1993.
6. Plaxis 2011 Material Models Manual.
7. Zhan, B. Rajani “Transfer Analysis of Buried Pipe in Different Backfills”, 1997.
8. Nataraja, M.C., Nalanda, Y. “Stress-Strain Behaviour of Flowable Fill”, 2008.
9. ASTM D6103 Standard Test Method for Flow Consistency of Controlled Low Strength Material (CLSM), 2004.
10. ASTM C143 Standard Test Method for Slump of Hydraulic-Cement Concrete, 2012.
11. ACI 229R-99 Controlled Low-Strength Materials, Reported by ACI committee 229.
12. ASTM D4832 Standard Test Method for Preparation and Testing of Controlled Low Strength Material (CLSM) Test Cylinders, 2010. ASTM C403 Standard Test Method for Time of Setting of Concrete Mixtures by Penetration Resistance, 2008.

13. ASTM D6024 Standard Test Method for Ball Drop on Controlled Low Strength Material (CLSM) to Determine Suitability for Load Application, 2007.
14. McGrath, T.J., Selig, E.T., and Webb, M.C., "Instrumentation for Monitoring Buried Pipe Behavior during Backfilling", Field Instrumentation for Soil and Rock, ASTM STP 1358, American Society for Testing and Materials, 1999.
15. Kawabata, T., Ling, H., Mohri, Y., and Shoda, D.. "Behavior of Buried Flexible Pipe under High Fills and Design Implications.", 2006. *J. Geotech. Geoenviron. Eng.*, 132(10), 1354–1359
16. Kawabata, T., Mohri, Y., Tamura, H., Shoda, D., and Oda, T. "Field Test for Buried Large Steel Pipes with Thin Wall" Pipelines 2006: pp. 1-8.
17. Webb, M.C., McGrath, T.J., and Selig, E.T., and "Field Test of Buried Pipe with CLSM Backfill", The Design and Application of Controlled Low-Strength Materials (Flowable Fill), ASTM STP 1331, American Society for Testing and Materials, 1998.
18. Howard, Amster. "The Reclamation E' Table, 25 Years Later", presented at Plastics Pipe XIII International Conference, 2006.
19. Leonhardt, G. "Loading Assumptions For Buried Glass-Fiber-Reinforced Plastic Pipes, Belastungsannahmen Bei Erdverlegten GFK-Rohre", 1983.
20. American Water Works Association, 2005, Fiber Glass Pipe Design, AWWA Manual 45.
21. Webb, M., Trebicki, D., and Smulders, P. (2002) Field Testing And Buckling Strength of Buried Large-Diameter Thin-Walled Steel Pipes. Pipelines 2002: pp. 1-35.

22. Dezfooli, Abolmaali, Razavi "Staged Construction Modeling of a Large Diameter Steel Pipe Using 3-D Nonlinear Finite Element Analysis", Transportation Research Board, 2013.
23. Cho, S. and Vipulanandan, C. (2004) Behavior of Flexible Pipe with Sand Backfill in Trench Condition and Verification with Finite Element Method. Pipeline Engineering and Construction: pp. 1-10.
24. Sharma, J., Najafi, M., Zheng, Z., and Jain, A. (2011) Laboratory Test of Statically-Loaded Large Diameter Steel Pipe with Native Backfill. ICPTT 2011: pp. 1244-1256.
25. Dezfooli, M.S., "Staged Construction Modeling Of Large Diameter Steel Pipes Using 3-D Nonlinear Finite Element Analysis", (Dissertation in Progress) 2013.



### Biographical Information

Franciele Bellaver is from Brazil where she graduated in Civil Engineering in the Universidade Federal do Rio Grande do Sul (UFRGS), in 2008. After finishing her studies she worked as a professional structural engineer designing bridges, overpasses and footbridges participating in projects that were important for the development of major highways in South Brazil. In January 2012, she moved to the United States to pursue her Master's Degree in Structural Engineering at the University of Texas at Arlington (UTA). At UTA she had the great opportunity to work with Dr. Abolmaali, as a Graduate Research Assistant, in the development of the finite element model for the Integrated Pipeline Project; an important project that will bring fresh water to North Texas impacting millions of people. At the time of the completion of this thesis, Franciele is working as an Engineer in Training designing bridges in a structural firm, and plans to get her Professional Engineer certification and continue to pursue her carrier in the United States.